

[www.bchindia.com](http://www.bchindia.com)

# PRICE LIST

Effective : 22nd May 2024



[www.bchindia.com](http://www.bchindia.com)

## Industrial Core Products



BHARTIA

BCH

BCH  
ELECTRIC  
LIMITED



# Modern facilities at Faridabad & Rudrapur



## Our Strengths

- ◆ State-of-the-art product development and R&D
- ◆ Modern manufacturing facilities
- ◆ Tool room with latest facilities
- ◆ Serving customers for five decades
- ◆ Presence in ~50 locations
- ◆ 650 channel partners
- ◆ ISO 14001:2015 and ISO 9001:2015 certified company

## Core Values

- ◆ Integrity
- ◆ Nurturing People
- ◆ Commitment to Customers
- ◆ Striving for Excellence
- ◆ Long Term Thinking

## Quality Policy

We as a member of BCH Electric Limited manufacturer of Low Voltage Switchgear & Controlgear products, are fully committed to provide Quality products and service in compliance with applicable Statutory and Regulatory requirements, to meet or exceed the customer need and expectations through -

- ◆ Continual improvement
- ◆ Involvement of employees
- ◆ Setting Quality objectives
- ◆ Training and development of employees

## Health & Safety Policy

We as a member of BCH Electric Limited manufacturer of Low Voltage Switchgear & Controlgear products, are fully committed to conduct Business in compliance to applicable Health & Safety legislation and regulation.

We shall continually improve through -

- ◆ Provide Safe & Healthy working conditions for the prevention of work related injury and ill health.
- ◆ Develop & maintain the Health & Safety objectives & targets and conduct health & safety programs for achieving the objectives and target.
- ◆ The prevention of accidents through the identification, assessment and elimination of workplace hazards and the promotion of health & safety awareness among its employees and contractors.
- ◆ Encourage employee's participation and consultation in matters affecting the health, safety and well being of our people and seek suggestions from our employees of ways in which health, safety & well being can be furthered.

The Health & safety policy is publicly available on request.

## Environmental Policy

We as a member of BCH Electric Limited manufacturer of Low Voltage Switchgear & Controlgear products, are fully committed to conduct Business in compliance to applicable Environmental legislation and regulation.

We shall continually improve through -

- ◆ Provide a framework for setting and reviewing environmental objectives and targets.
- ◆ Regularly review the impact of our activities on environment and strive to reduce the pollution/waste.
- ◆ Involve employees in our environmental program and provide necessary training to enable them to discharge their responsibilities towards environment management.
- ◆ Sustain the program of continual improvement in environment in environmental performance incorporating suitable metrics and monitoring.

The Environment policy is publicly available on request.

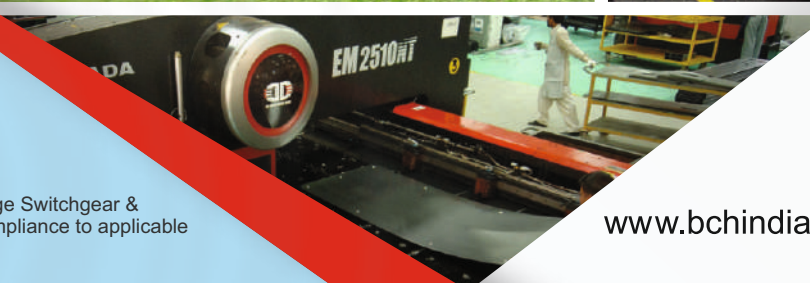
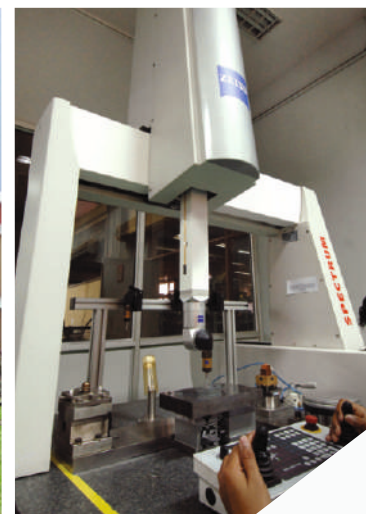

[www.bchindia.com](http://www.bchindia.com)

# Industrial Core Products

## INDEX

- Polycarbonate Plug & Socket BPX Series <sup>New</sup> ..... 1
- Plugs & Sockets..... 4
- Plug & Socket Boxes ..... 6
- BSG Foot Switches <sup>New</sup>..... 7
- Heavy Duty Foot Switches..... 7
- DC Contactors ..... 8
- Limit Switches..... 11
- AC Solenoid & Brakes..... 14
- DC Brakes... .. 15
- Pneumatic Timers ..... 21
- Punched Grid Resistors..... 22

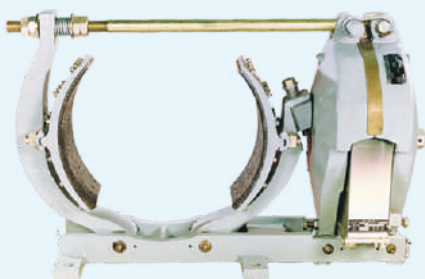



# Polycarbonate Plug & Socket BPX Series=





## BPX Range of Plugs/Socket/Connector- 16A to 125A:

Conform to International standards EN/IEC 60309-1 & 2

Panel Mounted Straight Socket - IP44						
	Amp	Poles	230V~ 50-60Hz	415V~ 50-60Hz	Lot size	MRP (₹) / Unit
	16	3		BPX1PSS341		10
4				BPX1PSS442	10	1070
5				BPX1PSS542	10	1085
32	3		BPX2PSS341		10	1150
	4			BPX2PSS442	10	1310
	5			BPX2PSS542	10	1325
63	3		BPX3PSS341		5	4585
	4			BPX3PSS442	5	4685
	5			BPX3PSS542	5	4715

Panel Mounted Straight Socket - IP67						
	Amp	Poles	230V~ 50-60Hz	415V~ 50-60Hz	Lot size	MRP (₹) / Unit
	16	3		BPX1PSS371		10
4				BPX1PSS472	10	1505
5				BPX1PSS572	10	1515
32	3		BPX2PSS371		10	1735
	4			BPX2PSS472	10	1980
	5			BPX2PSS572	10	2000
63	3		BPX3PSS371		5	5130
	4			BPX3PSS472	5	5150
	5			BPX3PSS572	5	5175
125	3		BPX4PSS371		2	17505
	4			BPX4PSS472	2	17595
	5			BPX4PSS572	2	17695

Panel Mounted Angled Socket - IP44						
	Amp	Poles	230V~ 50-60Hz	415V~ 50-60Hz	Lot size	MRP (₹) / Unit
	16	3		BPX1PAS341		10
4				BPX1PAS442	10	1080
5				BPX1PAS542	10	1095
32	3		BPX2PAS341		10	1150
	4			BPX2PAS442	10	1330
	5			BPX2PAS542	10	1345
63	3		BPX3PAS341		5	4585
	4			BPX3PAS442	5	4715
	5			BPX3PAS542	5	4740

Panel Mounted Angled Socket - IP67						
	Amp	Poles	230V~ 50-60Hz	415V~ 50-60Hz	Lot size	MRP (₹) / Unit
	16	3		BPX1PAS371		10
4				BPX1PAS472	10	1505
5				BPX1PAS572	10	1520
32	3		BPX2PAS371		10	1735
	4			BPX2PAS472	10	1980
	5			BPX2PAS572	10	1995
63	3		BPX3PAS371		5	5130
	4			BPX3PAS472	5	5150
	5			BPX3PAS572	5	5175
125	3		BPX4PAS371		2	17505
	4			BPX4PAS472	2	17595
	5			BPX4PAS572	2	17695

Surface Mounted Socket - IP44						
	Amp	Poles	230V~ 50-60Hz	415V~ 50-60Hz	Lot size	MRP (₹) / Unit
	16	3		BPX1WS341		10
4				BPX1WS442	10	1180
5				BPX1WS542	10	1195
32	3		BPX2WS341		10	1330
	4			BPX2WS442	10	1450
	5			BPX2WS542	10	1470
63	3		BPX3WS341		3	5240
	4			BPX3WS442	3	5250
	5			BPX3WS542	3	5275

Surface Mounted Socket - IP67						
	Amp	Poles	230V~ 50-60Hz	415V~ 50-60Hz	Lot size	MRP (₹) / Unit
	16	3		BPX1WS371		10
4				BPX1WS472	10	2290
5				BPX1WS572	10	2305
32	3		BPX2WS371		10	2240
	4			BPX2WS472	10	2765
	5			BPX2WS572	10	2790
63	3		BPX3WS371		3	6590
	4			BPX3WS472	3	6615
	5			BPX3WS572	3	6665
125	3		BPX4WS371		1	21525
	4			BPX4WS472	1	23615
	5			BPX4WS572	1	23715

Standard Connector - IP44						
	Amp	Poles	230V~ 50-60Hz	415V~ 50-60Hz	Lot size	MRP (₹) / Unit
	16	3		BPX1SC341		10
4				BPX1SC442	10	975
5				BPX1SC542	10	985
32	3		BPX2SC341		10	1070
	4			BPX2SC442	10	1340
	5			BPX2SC542	10	1350
63	3		BPX3SC341		5	5620
	4			BPX3SC442	5	5635
	5			BPX3SC542	5	5660

Standard Connector - IP67						
	Amp	Poles	230V~ 50-60Hz	415V~ 50-60Hz	Lot size	MRP (₹) / Unit
	16	3		BPX1SC371		10
4				BPX1SC472	10	2080
5				BPX1SC572	10	2100
32	3		BPX2SC371		10	2410
	4			BPX2SC472	10	2705
	5			BPX2SC572	10	2720
63	3		BPX3SC371		5	5715
	4			BPX3SC472	5	5735
	5			BPX3SC572	5	5760
125	3		BPX4SC371		1	18365
	4			BPX4SC472	1	18725
	5			BPX4SC572	1	18825

# Polycarbonate Plug & Socket BPX Series=





## BPX Range of Plugs/Socket/Connector- 16A to 125A:

Conform to International standards EN/IEC 60309-1 & 2

Standard Plug - IP44						
	Amp	Poles	230V~ 50-60Hz	415V~ 50-60Hz	Lot size	MRP (₹) / Unit
	16	3		BPX1SP341		10
4				BPX1SP442	10	765
5				BPX1SP542	10	775
32	3		BPX2SP341		10	925
	4			BPX2SP442	10	1120
	5			BPX2SP542	10	1130
63	3		BPX3SP341		5	4370
	4			BPX3SP442	5	4400
	5			BPX3SP542	5	4425

Standard Plug - IP67						
	Amp	Poles	230V~ 50-60Hz	415V~ 50-60Hz	Lot size	MRP (₹) / Unit
	16	3		BPX1SP371		10
4				BPX1SP472	10	1635
5				BPX1SP572	10	1650
32	3		BPX2SP371		10	1865
	4			BPX2SP472	10	1980
	5			BPX2SP572	10	2005
63	3		BPX3SP371		5	5020
	4			BPX3SP472	5	5050
	5			BPX3SP572	5	5075
125A	3		BPX4SP371		1	15795
	4			BPX4SP472	1	15825
	5			BPX4SP572	1	15925

Phase Inverter Plug - IP44					
	Amp	Poles	415V~ 50-60Hz	Lot size	MRP (₹) / Unit
	16	5		BPX1PIP542	10
32		5	BPX2PIP542	10	1810

Phase Inverter Plug - IP67					
	Amp	Poles	415V~ 50-60Hz	Lot size	MRP (₹) / Unit
	16	5		BPX1PIP572	10
32		5	BPX2PIP572	10	3030

Panel Mounted Plug - IP44						
	Amp	Poles	230V~ 50-60Hz	415V~ 50-60Hz	Lot size	MRP (₹) / Unit
	16	3		BPX1PP341		10
4				BPX1PP442	10	1185
5				BPX1PP542	10	1215
32	3		BPX2PP341		10	1255
	4			BPX2PP442	10	1465
	5			BPX2PP542	10	1500
63	3		BPX3PP341		5	4575
	4			BPX3PP442	5	4605
	5			BPX3PP542	5	4680

Panel Mounted Plug - IP67						
	Amp	Poles	230V~ 50-60Hz	415V~ 50-60Hz	Lot size	MRP (₹) / Unit
	16	3		BPX1PP371		10
4				BPX1PP472	10	2435
5				BPX1PP572	10	2480
32	3		BPX2PP371		10	2375
	4			BPX2PP472	10	2545
	5			BPX2PP572	10	2595
63	3		BPX3PP371		5	5080
	4			BPX3PP472	5	5110
	5			BPX3PP572	5	5130
125A	3		BPX4PP371		2	17095
	4			BPX4PP472	2	18250
	5			BPX4PP572	2	18505

Surface Mounted Plug - IP44						
	Amp	Poles	230V~ 50-60Hz	415V~ 50-60Hz	Lot size	MRP (₹) / Unit
	16	3		BPX1WP341		10
4				BPX1WP442	8	2160
5				BPX1WP542	10	2190
32	3		BPX2WP341		10	2665
	4			BPX2WP442	10	3095
	5			BPX2WP542	10	3150
63	3		BPX3WP341		2	6135
	4			BPX3WP442	2	6185
	5			BPX3WP542	2	6275

Surface Mounted Plug - IP67						
	Amp	Poles	230V~ 50-60Hz	415V~ 50-60Hz	Lot size	MRP (₹) / Unit
	16	3		BPX1WP371		10
4				BPX1WP472	8	2920
5				BPX1WP572	10	2970
32	3		BPX2WP371		10	5085
	4			BPX2WP472	10	5225
	5			BPX2WP572	10	5305
63	3		BPX3WP371		2	6890
	4			BPX3WP472	2	6920
	5			BPX3WP572	2	7020

# Polycarbonate Plug & Socket BPX Series=



## BPX Range of Socket Outlet with Switch and Mechanical Interlock

Conform to International standards EN/IEC 60309-1 & 2

### Socket Outlet with Switch and Mechanical Interlock

#### Horizontal Type - IP44

	Amp	Poles	230V~ 50-60Hz	415V~ 50-60Hz	Lot size	MRP (₹) / Unit
	16	3		BPX1MIH341		4
4				BPX1MIH442	4	10860
5				BPX1MIH542	4	10910

#### Horizontal Type - IP67

	Amp	Poles	230V~ 50-60Hz	415V~ 50-60Hz	Lot size	MRP (₹) / Unit
	16	3		BPX1MIH371		4
4				BPX1MIH472	4	11060
5				BPX1MIH572	4	11100

#### Vertical Type - IP44

	Amp	Poles	230V~ 50-60Hz	415V~ 50-60Hz	Lot size	MRP (₹) / Unit
	16	3		BPX1MIV341		1
4				BPX1MIV442	1	13245
5				BPX1MIV542	1	13295
32	3		BPX2MIV341		1	12355
	4			BPX2MIV442	1	15030
	5			BPX2MIV542	1	15080
63	3		BPX3MIV341		1	26915
	4			BPX3MIV442	1	28150
	5			BPX3MIV542	1	28200
-						

#### Vertical Type - IP67

	Amp	Poles	230V~ 50-60Hz	415V~ 50-60Hz	Lot size	MRP (₹) / Unit
	16	3		BPX1MIV371		1
4				BPX1MIV472	1	13445
5				BPX1MIV572	1	13495
32	3		BPX2MIV371		1	12555
	4			BPX2MIV472	1	15230
	5			BPX2MIV572	1	15280
63	3		BPX3MIV371		1	27165
	4			BPX3MIV472	1	28400
	5			BPX3MIV572	1	28450
125A	3		BPX4MIV371		1	89640
	4			BPX4MIV472	1	97700
	5			BPX4MIV572	1	97750

### Socket Outlet with Duo Interlock and DIN Rail

#### Vertical Type - IP44

	Amp	Poles	230V~ 50-60Hz	415V~ 50-60Hz	Lot size	MRP (₹) / Unit
	16	3		BPX1MID341		1
4				BPX1MID442	1	15285
5				BPX1MID542	1	15795
32	3		BPX2MID341		1	12230
	4			BPX2MID442	1	17590
	5			BPX2MID542	1	17600
63	3		BPX3MID341		1	24920
	4			BPX3MID442	1	27240
	5			BPX3MID542	1	28890
-						

#### Vertical Type - IP67

	Amp	Poles	230V~ 50-60Hz	415V~ 50-60Hz	Lot size	MRP (₹) / Unit
	16	3		BPX1MID371		1
4				BPX1MID472	1	15585
5				BPX1MID572	1	16095
32	3		BPX2MID371		1	12450
	4			BPX2MID472	1	17800
	5			BPX2MID572	1	17850
63	3		BPX3MID371		1	25190
	4			BPX3MID472	1	27540
	5			BPX3MID572	1	29150
125A	3		BPX4MID371		1	92915
	4			BPX4MID472	1	100265
	5			BPX4MID572	1	100305





## Metal Clad - Plugs & Sockets Type 'MP' & 'MS'

HSN Code : 8536

Rating	Pins	Type	Cat No.	MRP [₹]
20A, 250V	2P + E	Plug	MP20	305
		Socket	Ms20	340
30A, 440V	3P + E	Plug	MP30	705
		Socket	Ms30	745



## Plastic Plugs & Socket Type 'PS'

HSN Code : 8536

Rating	Pins	Type	Cat No.	MRP [₹]
20A, 250V	3	Plug	PS16AA7	335
		Flush Mounting Socket	PS16BA7	475
		Socket with Wall Mounting Box	PS16DA7	590
20A, 415V	4	Plug	PS16AA1	410
		Flush Mounting Socket	PS16BA1	620
		Socket with Wall Mounting Box	PS16DA1	725
32A, 415V	3	Plug	PS32AA7	695
		Socket	PS32BA7	695
	4	Plug	PS32AA1	730
		Socket	PS32BA1	730
	5	Plug	PS32AA5	775
		Socket	PS32BA5	775

- Self Locking design : Extremely safe
- Plug cannot be pulled out in fully engaged position
- Auto closing socket shutter
- Reliable Earthing
- Shrouded Terminals for safety

## Heavy duty Metal-Control 'SS'



## Heavy Duty Metal - Control Plugs & Sockets Type 'SS'

HSN Code : 8536

Rating	Pins	Type	Cat No.	MRP [₹]
12A, 415V (Control)	12	Panel Mounting Socket	2499/12	2405
		Plug with inclined Handle	299/12B	1805

## Heavy duty Metal-Power 'SS'



## Heavy Duty Metal - Power Plugs & Sockets Type 'SS'

HSN Code : 8536

Rating	Pins	Type	Cat No.	MRP [₹]
30A, 415V	3	Panel Mounting Socket	2415B	1000
		Plug with inclined Handle	215B	980
30A, 415V	4	Panel Mounting Socket	2413B	1045
		Plug with inclined Handle	213B	1020
30A, 415V	5	Panel Mounting Socket	2417B	1090
		Plug with inclined Handle	217B	1065

Note : \*Loose Conduit Box Straight (Cat. No. 9J101) MRP - Rs. 380/- each  
\*Spare Handle Inclined (Cat. No. 9J108) MRP -Rs. 190/- each.

HSN Code : 8538

## Heavy Duty Metal Plug & Sockets Type 'DS' - 5 Pin (with Integral Switching Device)

HSN Code : 8536

Rating	Pins	Type	Cat No.	MRP[₹]
16A, 415V	5	Plug	DS1A7A1	1620
		Socket	DS1B7A1	2010
		Handle Assembly	SP91PH	315
32A, 415V	5	Plug	DS3A7A1	2650
		Socket	DS3B7A1	3220
		Handle Assembly	SP93PH	330
63A, 415V	5	Plug	DS6A7A1	4125
		Socket	DS6B7A1	5690
		Handle Assembly	SP96PH	460
125A, 415V	5	Plug	DS9A7A1	12165
		Socket	DS9B7A1	16995
		Handle Assembly	SP99PH	1130

Note : Power Receptacles with or without SFU/SDFU/MCB/MCCB having loop-in / loop-out facility is available on request.



- Range from 16A to 125 A
- 5 Pin configuration ( 3P+N+E)
- Plug cannot come out in ON condition ( Integral Interlocking)

- Spring loaded Butt type contacts  
- Self aligning and self wiping

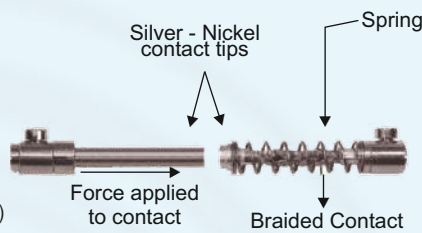

Quick Disconnect

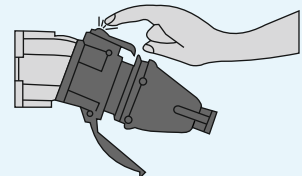

**Sparkless  
Butt type contact**

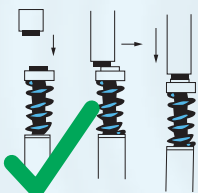

- Self aligning self wiping
- Spring loaded for consistent pressure
- Silver nickle material for extremely low temperature rise

Safety Disk



Vibration proof termination

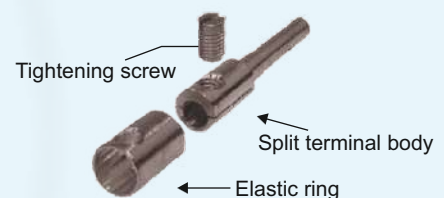



## Metal Clad - Plug & Socket Box Type 'MPSEU'

HSN Code : 8536

Rating	Pins	Mounting	Type	Cat No.	MRP [₹]
20A, 250V	2P + E	Universal	Plug & Socket Box - SP-MCB Cutout	MPSEU201	1365
20A, 250V	2P + E	Universal	Plug & Socket Box - DP-MCB Cutout	MPSEU202	1365
30A, 440V	3P + E	Universal	Plug & Socket Box - TPN-MCB Cutout	MPSEU301	3425



## Plastic - Plug & Socket Box Type 'PSEU / PSEF'

HSN Code : 8536



Rating	Pins	Mounting	Type	Cat No.	MRP [₹]
20A, 250V	3	Universal	Plug & Socket Box with SP MCB Cutout	PSEU201	1640
			Plug & Socket Box with DP-MCB Cutout	PSEU202	1685
		Flush	Plug & Socket Box with SP MCB Cutout	PSEF201	1640
			Plug & Socket Box with DP-MCB Cutout	PSEF202	1685
32A, 415V	4	Universal	Plug & Socket Box with 4P MCB Cutout	PSEU324	3555
			5	PSEU325	3625
	4	Flush	Plug & Socket Box with 4P MCB Cutout	PSEF324	3555
			5	PSEF325	3625

## Heavy Duty Metal - Plug & Socket Box Type 'SSEU'

HSN Code : 8536

Rating	Pins	Mounting	Type	Cat No.	MRP [₹]
30A, 415V	3	Universal	Plug & Socket Box with SP MCB Cutout	SSEU303-MCB1P	4015
			Plug & Socket Box with DP MCB Cutout	SSEU303	4015
	4	Universal	Plug & Socket Box with 4P MCB Cutout	SSEU304	4120
			5	SSEU305	4210

## Stainless Steel Cover Plug & Socket Box Type 'PSEU-SSC'/SSEU-SSC'

HSN Code : 8536



Rating	Pins	Mounting	Type	Cat No.	MRP [₹]
20A, 250V 32A, 415V	3	Universal	P&S Box with 'PS' P&S and SP MCB Cutout	PSEU201-SSC	2055
			P&S Box with 'PS' P&S and 4P MCB Cutout	PSEU325-SSC	4150
30A, 415V	3	Universal	Plug & Socket Box with SP MCB Cutout	SSEU303-SSC-MCB1P	4610
			Plug & Socket Box with DP MCB Cutout	SSEU303-SSC	4610
	4	Universal	Plug & Socket Box with 4P MCB Cutout	SSEU304-SSC	4720
	5	Universal	Plug & Socket Box with 3P MCB Cutout	SSEU305-SSC-MCB3P	4920
			Plug & Socket Box with 4P MCB Cutout	SSEU305-SSC	4810

# BSG Foot Switch



**BSG2M**

- Full Metal Body with Shielded Guard for Pedal
- 2 Positions
- Yellow Colour Shielded Guard for better visibility

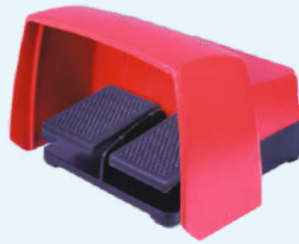

**BSG2C**

- Full Metal Body with Shielded Guard for Pedal
- Glass Filled Nylon Pedal
- 2 Positions
- Red Colour Shielded Guard for better visibility

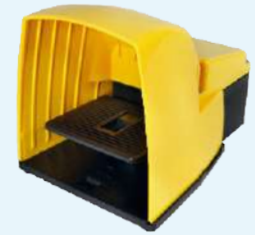

**BSG2P**

- Full Plastic Body with Shielded Guard for Pedal
- 2 Positions
- Yellow Colour Shielded Guard for better visibility

**HSN Code : 8538**

BSG Range of Foot switches		
Cat code	Description	MRP [₹]
BSG2MX1	FOOT SWITCH METAL GUARD & SHIELD 1NO+1NC	5390
BSG2MX2	FOOT SWITCH METAL GUARD & SHIELD 2NO+2NC	5780
BSG2CY1	FOOT SWITCH DOUBLE PEDAL 2 X 1NO+1NC	8290
BSG2PX1	FOOT SWITCH PLASTIC GUARD&SHIELD 1NO+1NC	2590
BSG2PX2	FOOT SWITCH PLASTIC GUARD&SHIELD 2NO+2NC	2980

# FSG Foot Switch

**HSN Code : 8536**



Number of Contact Blocks	Total contacts available	No. of position	Description	Cat. No.	MRP [₹]	Lot Size
One	1NO+1NC	2	With Guard	FSGX1	5215	1
One	1NO+1NC	2	With Latch	FSGX1L	5490	
One	2NO+2NC	2	With Guard	FSGX2	5655	
One	2NO+2NC	2	With Latch	FSGX2L	5905	
Two	2NO+2NC	2	With Guard	FSGY1	6390	
Two	2NO+2NC	2	With Latch	FSGY1L	6800	
Two	4NO+4NC	2	With Guard	FSGY2	7455	
Two	4NO+4NC	2	With Latch	FSGY2L	7595	
Two	2NO+2NC	3	With Guard	FSGZ1M	6490	
Two	4NO+4NC	3	With Guard	FSGZ2M	7435	

Note : Latching unit (with suffix L) is provided with X & Y versions only.

## Spares for Foot Switch

**HSN Code : 8538**



Description	Suitable For	Cat No.	MRP [₹]
Spare Contact Block 1NO+1NC	FSG & BSG	SP20S1	920
Spare Contact Block 2NO+2NC	FSG & BSG	SP20S2	1155
Spare Cover with Guard	FSG	SP20CG	2095

- 2 Position and 3 Position
- 1NO+1NC/2NO+2NC/4NO+4NC contact blocks
- With Guard
- Oil tight and water tight enclosure for contact block
- Mechanical and electrical life : 10 million operation
- Suited for heavy duty applications such as :
  - Machine Tools
  - Rubber and Tyre making machines
  - SPMs
  - Welding Machines
- Suffix X1 = One Block of 1NO+1NC
- X2 = One Block of 2NO+2NC
- Y1 = Two Blocks of 1NO+1NC
- Y2 = Two Blocks of 2NO+2NC

## DC Mill Duty Contactor HSN Code : 8536

No. of poles	(A)	Auxilliary Contacts	Cat. No.	MRP [₹]
<b>50 Amperes</b>				
Single pole Normally Open	15A 25A 50A	2NO+2NC 2NO+2NC 2NO+2NC	912x1522 912x2522 912x5022	On request On request 43105
Double pole Normally Open	15A 25A 50A	2NO+2NC 2NO+2NC 2NO+2NC	D912x1522 D912x2522 D912x5022	On request On request 92645
Mechanically Interlocked 2 Nos. SP NO	15A 25A 50A	2NO+2NC 2NO+2NC 2NO+2NC	M912x1522 M912x2522 M912x5022	On request On request 102745
<b>150 Amperes</b>				
Single pole Normally Open	150A	2NO+2NC	914x22	73590
Double pole Normally Open	150A	2NO+2NC	D914x22	157770
Mechanically Interlocked 2 Nos. SP NO	150A	2NO+2NC	M914x22	166495
Single pole Normally Closed	150A	1NO+1NC	924x11	75805
Double Pole Normally Closed	150A	2NO+2NC	D924x22	160810
Single pole Normally Open with Holdout Coil #	150A	1NO+1NC	934x11/#	79780
Single pole Normally Open with AC Blow out Coil	150A	2NO+2NC	974x22	93295
<b>300 Amperes</b>				
Single pole Normally Open	300A	2NO+2NC	915x22	106865
Double pole Normally Open	300A	2NO+2NC	D915x22	227565
Mechanically Interlocked 2 Nos. SP NO	300A	2NO+2NC	M915x22	236590
Single pole Normally Closed	300A	1NO+1NC	925x11	107400
Double Pole Normally Closed	300A	2NO+2NC	D925x22	231980
Single pole Normally Open with Holdout Coil #	300A	1NO+1NC	935x11/#	115955
Single pole Normally Open with AC Blow out Coil	300A	2NO+2NC	975x22	135115



- From 50 A to 600 A
- Conforms to NEMA Standards
- Ready to use mechanically interlocked version
- Normally closed version
- Hold on coil for time delay
- Mechanical life : 20 million operation
- Electrical life : 1 million operation

Unique Arc quenching system with blow out coils for switching heavy duty loads

## DC Mill Duty Contactor HSN Code : 8536

No. of poles	(A)	Auxilliary Contacts	Cat. No	MRP [₹]
<b>600 Amperes</b>				
Single pole Normally Open	600A	2NO+2NC	916x22	238135
Double pole Normally Open	600A	2NO+2NC	D916x22	494460
Mechanically Interlocked 2 Nos. SP NO	600A	2NO+2NC	M916x22	502470
Single pole Normally Closed	600A	1NO+1NC	926x11	244780
Single pole Normally Open with Holdout Coil#	600A	1NO+1NC	936x11/#	302535
Single pole Normally Open with AC Blow out Coil	600A	2NO+2NC	976x22	311380

# For 934 / 935 / 936 with holdout coil use hold out suffix code from table on page no.44

\* For coil voltage refer table on page no.11

\* 150, 300 & 600 Amps replace 'x' by 'y' for surface mounting rear connection, 'z' for elevated mounting rear connection

\* Add Rs. 4885/- for AC Control

## Double Pole DC Mill Duty Contactor HSN Code : 8536

A	Auxilliary Contacts	Cat. No.	Unit Price [₹]
150A	2NO+2NC	954x22	225195
300A	2NO+2NC	955x22	262745

## DC Mill Duty Contactors - Spares

HSN Code : 8538

Description	Qty. Reqd.	50A		150A		300A		600A	
		Cat. No.	MRP [₹]	Cat. No.	MRP [₹]	Cat. No.	MRP [₹]	Cat. No.	MRP [₹]
DC Arc Chute Assy. Consisting of a. LH Arc Shield b. RH Arc Shield c. DC Blow Out Arc Horn d. DC Blow Out Arc Piece e. DC Blow Out Spacer Assy. f. Polarity Wire g. Latch Strips (Top & Bottom) h. Hardware for Polarity Wire & Latch	1 Set	9C9J101*	20885	9C9P101	35760	9C9T101	51840	9C9V101	112825
AC Arc Chute Assy. Consisting of a. LH Arc Shield b. RH Arc Shield c. AC Blow Out Pole Piece d. AC Blow Out Spacer Assy. e. Polarity Wire f. Latch Strips (Top & Bottom) g. Hardware for Polarity Wire & Latch	1Set	-	-	9C9P102	On request	9C9T102	On request	9C9V102	On request
Fixed & Moving Contacts	1 Set	9C9J105	4745	9C9P105	6530	9C9T105	10590	9C9V105	28785
Contact Lever with Braid (for Single Pole)	1 No.	9C9J106	5770	9C9P106	9405	9C9T106	12450	9C9V106	21590
Contact Lever with Braid (for Double Pole) <sup>†</sup>	1 No.	9C9J106	5770	9C9P106	9405	9C9T106	12450	9C9V103	21590
Set of Armature Spares Consisting of a. Adjusting Pin b. Contact lever spring c. Contact lever spring pin with circlip d. Armature hinge pin e. Armature Securing pin	1 Set	9C9J107	1970	9C9P107	2730	9C9T107	3935	9C9V107	5710
Set of Armature Spares for 924, 925, 926 Consisting of a. Adjusting Pin b. Contact lever spring c. Contact lever spring pin with circlip d. Armature hinge pin e. Armature Securing pin f. Armature spring g. Spring retaining washer	1 Set	-	-	9C9P108	3330	9C9T108	5865	9C9V108	7075
Set of Armature Spares for 934/935/936 Consisting of a. Adjusting pin b. Contact lever spring c. Contact lever hinge pin d. Armature hinge pin e. Armature securing pin f. Armature spring g. Spring retaining washer h. Adjusting screw	1 Set	-	-	9C9P109	3975	9C9T109	5865	9C9V109	7510
Terminal Block	1	9C9J110	2660	9C9P110	3480	9C9T110	4865	9C9V110	6075
No Volt Coil for 912, 914, 915, 916, 934, 935 & 936 **Suffix voltage code	1	9C9J111■	10655	9C9P111■	16295	9C9T111■	21440	9C9V111■	36930
No Volt Coil for 924, 925, 926 **Suffix voltage code	1	-	-	9C9P112■	21440	9C9T112■	33295	9C9V112■	53780
Coil clamp for 914 & 934	1	-	-	9C9P118	375	-	-	-	-
Coil clamp for 924, 915, 935, 916 & 936	1	-	-	9C9P118	375	9C9T118	375	9C9V118	On request

- Suffix coil voltage code from table on page 44
- Please add Rs. 4885 for AC control

- \* Only item a to e is supplied in this set
- † For two Poles, need to order for 2 Nos.



## DC Mill Duty Contactors - Spares & Accessories HSN Code : 8538

Description	Cat. No.	MRP [₹]
1NO+1NC Auxilliary Contact Block	AC10E11	8320
2NO Auxilliary Contact Block	AC10E20	8320
2NC Auxilliary Contact Block	AC10E02	8320
Single unit driver with mounting plate (50A)	9C9J115	On request
Double unit driver with mounting plate (50A)	9C9J116	On request
Single unit driver with mounting plate (150-600A)	9C9P116	On request
Double unit driver with mounting plate (150-600A)	9C9P117	On request
Hold out coil for 934, 935 & 936	9C9P113-#	25870
Condenser 50 + 50uF for 934, 935 & 936	9C9P114	1430
Mechanical interlock for 150/300/600A	AC10M4/M8/M12	9270
Rectifier 110/240 V	SP30R	4895

# Suffix hold out coil code from table

## Hold Out Coil Suffix table - 934/935/936

Hold out coil type	Voltage	Suffix code
494-2	100/125	2
494-7	400/450	7
492-12	100/125	12
494-43	200/250 & 400/550	43



- Magnetic Operated Overload relay for heavy duty applications
- From 1.5A to 600A
- Instantaneous and Time delay tripping
- Manual and automatic resetting
- 1NO + 1NC Contacts

## DC Magnetic Overload Relays \*

HSN Code : 8536

Cat. No.	Coil No.	Continuous Rating	Range Amps	MRP [₹]
B3A23	159-10	2.8	1.5 to 3.5	24140
B3B23	159-5	3.9	3 to 7	
B3C23	159-4	5.4	5 to 13	
B3E23	159-3	10.9	8 to 24	
B3F23	159-2	16.9	10 to 30	
B3G23	159-1	21.9	20 to 40	
B3H23	159-8	34.9	25 to 65	
B3J23	159-6	50.0	35 to 75	28285
B3K23	179-39	69.0	40 to 120	
B3L23	179-38	109.0	70 to 190	
B3M23	179-37	179.0	100 to 300	30840
B3N23	179-36	299.0	200 to 600	
B3Y23	179-36.2	199.0	200 to 600	37515
B3P23		549.0	300 to 900	
B3R23		500.0	500 to 1500	

\* With 1NO + 1NC Contacts

## Coil Voltage table - DC Mill Duty Contactor

		24V	48V	55V	110V	220V	240V	250V	
DC CONTACTOR	PRODUCT	DC	DC	DC	AC	DC	DC	AC	F1
	912X	U1	-	Q1	A1R	A1	B1	K1R	F1
	914;934X	U1	W1	Q1	A1R	A1	B1	K1R	F1
	935X;924;915	U1	W1	Q1	A1R	A1	B1	K1R	F1
	925	-	-	-	-	A1	B1	K1R	F1
	916&936	U1	W1	Q1	A1R	A1	B1	K1R	F1
	D912-D916	-	W1	-	A1R	A1	B1	K1R	F1

1. For other coil voltages, please contact nearest sales office
2. AC control is not available for 934, 935, 936 versions.
3. For ordering spare coils for D912, D914, D915 and D916 Contactors, please order coils with 50% voltage rating as that of control voltage. Example to order coils for D914 X 22B1 (which is a 220V DC DP Contactor), please order spare coils with 110V DC rating.

## Heavy Duty Limit Switch - Snap Action Type NL IP 67

HSN Code : 8536

Type	Description	Cat. No. Screw Terminal (1NO+1NC)	MRP [₹]	Cat.No. Precabled (1NO+1NC)	MRP [₹]	Cat. No. Screw Terminal (2NO+2NC)	MRP [₹]	Cat. No. Precabled (2NO+2NC)	MRP [₹]
Roller Lever	Standard-38MM Standard-76.2mm Adjustable	NLL1 NLL2 NLLA	2305	NLL1C NLL2C NLLAC	2515	NLL1-22 NLL2-22 NLLA-22	3520	NLL1-22C NLL2-22C NLLA-22C	3645
	Maintained Type Maintained Type Maintained Type	NLL1M NLL2M NLLAM	2590	NLL1MC NLL2MC NLLAMC	2720	NLL1M-22 NLL2M-22 NLLAM-22	3895	NLL1M-22C NLL2M-22C NLLAM-22C	3965
Push Roller	Top Side	NLTPR	2305	NLTPRC	2515	NLTPR-22	3520	NLTPR-22C	3645
		NLSPR	2535	NLSPRC	2720	NLSPR-22	3800	NLSPR-22C	3965
Push Button	Top Adjustable Side Adjustable	NLTPBA	2305	NLTPBAC	2515	NLTPBA-22	3425	NLTPBA-22C	3645
		NLSPBA	2535	NLSPBAC	2720	NLSPBA-22	3800	NLSPBA-22C	3965
Cat Whisker	Nylon Rod Steel Rod	NLCW	2025	NLCWC	2180	NLCW-22	3350	NLCW-22C	3520
		NLJW	2305	NLJWC	2465	NLJW-22	3520	NLJW-22C	3645

- IP 67 degree of Protection
- Choice of 16 Operating Heads
- Interchangeable heads ensures complete modularity and flexibility
- Zinc Die cast body for Heavy duty applications
- Easily replaceable contact blocks
- Precabled version with 2m cable length

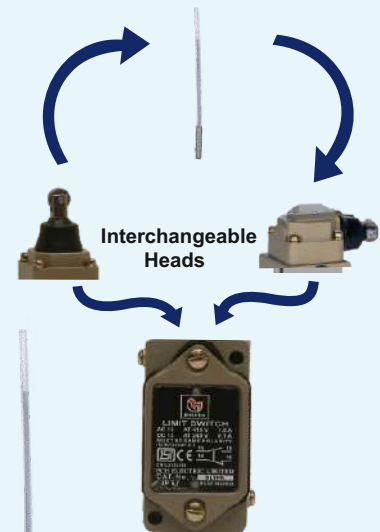



## Mini Limit Switch NEW

HSN Code : 8536

Type		Cat. No.	MRP [₹]
General Purpose Type		DLSMAR	1520
Top Plunger	Standard	DLSMPP	1520
Push Roller	Standard	DLSMRP	1520
Push Roller	Cross	DLSMRPX	1520
Roller Lever	39mm	DLSMRL	1520
Roller Lever	Adjustable	DLSMRLA	1570
Rod Arm	Adjustable	DLSMJWA	1570
Cat's Whisker	Steel Spring	DLSMSW	1665
Flexible Rod	Nylon	DLSMSR	1665

- Conforming to IS/IEC 60947-5-1
- Compact Design requiring less mounting space
- Zinc Die cast base & high end polyamide cover ensuring robustness & excellent aesthetics
- Unique Cross bar contacts for enhanced reliability
- Dust proof, Water proof & Oil resistance construction

### Applications

- Lifts and Escalators
- Machine Tools
- Food and Beverages
- Textile Machines
- Packaging & Printing Machines

### Available Operating Heads

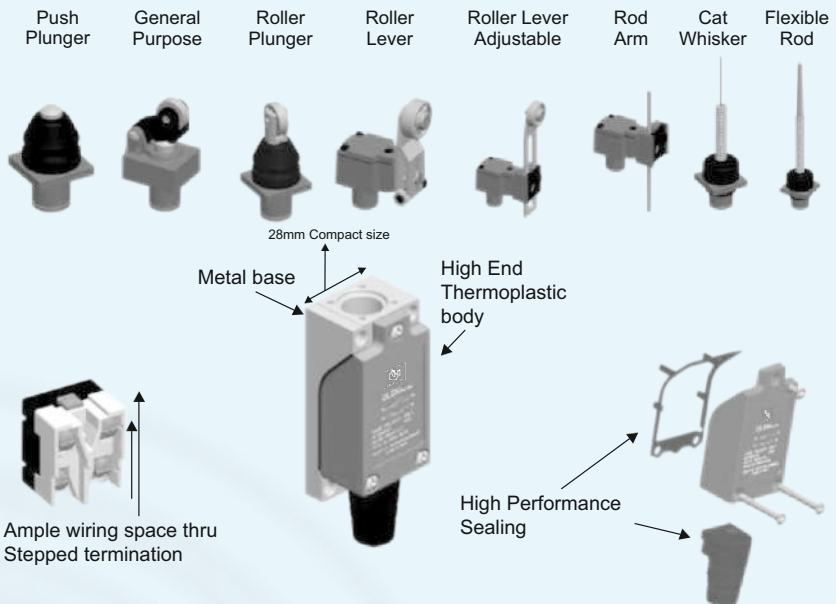

## Precision Limit Switch

HSN Code : 8536



- Conforming to IS/IEC 60947-5-1
- Snap action contacts
- Frequency of operation 2500 Operations / hr
- Mechanical life : 20 million operations
- Electrical life : 10 million operations

Type of Operator	1NO+1NC		2NO+2NC		Lot Size
	Cat. No.	MRP [₹]	Cat. No.	MRP [₹]	
Roller Lever	PSRL-L or R	980	PSRL-L-2 or R-2	1205	1
Six Inch Lever	PSSIL-L or R	980	PSSIL-L-2 or R-2	1205	
Top Push Roller	PSTPR*	980	PSTPR*-2	1205	
Top Push Button	PSTPB	980	PSTPB-2	1205	
Type	Cat. No	MRP [₹]	Cat. No	MRP [₹]	Lot Size
Spare Contact Block	SP20S1	920	SP20S2	1155	

\* A - Top push roller in line with contact block  
 B - Top push roller perpendicular to contact block

## Limit Switch for 125°C Application\*

HSN Code : 8536

Type	Cat. No.	MRP [₹]
with 1NO + 1NC Roller Lever Top Push Roller	LL1-150S-M LTPR-150S-M	On Request

\*Refer to our nearest sales office for specification & details

## Heavy Duty General Purpose Limit Switch

HSN Code : 8536

Snap Action Type L	Angular Roller Top Plunger	LLGS LPGS	1545
-----------------------	-------------------------------	--------------	------

## Oil Tight Limit Switch - Snap Action Type L IP 65

HSN Code : 8536

Type	Description	Cat. No.	MRP [₹]
Roller Lever	Standard-38MM	LL1	3305
	Standard-76.2mm	LL2	
	Adjustable	LLA	
Push Roller	Maintained Type LL1	LL1M	3455
	Maintained Type LL2	LL2M	
	Maintained Type LLA	LLAM	
Push Button	Top Adjustable	LTPR	3230
	Side Adjustable	LSPR	3635
Cat Whisker	Top Adjustable	LTPBA	3505
	Side Adjustable	LSPBA	
Fork Type	Nylon Rod	LCW	2650
	Steel Rod	LJW	3290
Fork Type	Roller in same line	LLF	2980
	Offset Rollers	LLFO	2980
	Roller in same line	LLFM	3480
	Maintained Offset Rollers Maintained	LLFOM	3480

## Oil Tight Limit Switch - Spares

HSN Code : 8538

Description	Suitable for	Cat. No.	MRP [₹]
38 mm lever	NLL1, LL1	SP40L1	555
76.2 mm lever	NLL2, LL2	SP40L2	700
Adjustable lever	NLLA, LLA	SP40LA	700
Fork lever in Line	LLF	SP40LF	850
Fork lever Offset	LLFO	SP40LFO	850
Operating Head	LLGS, LPGS	SP40HLG	1005
Operating Head	Lever Type	SP40HL	1090
Operating Head Maintained	Lever Type	SP40HLM	1255
Operating Head	Top Push	SP 40HTP*	1090
	Side Push	SP 40HSP*	1205
Operating Head	Cat Whisker Nylon Rod	SP40CW	745
	Cat Whisker Steel Rod	SP40JW	1005
Limit Switch Unit Assembly 1NO+1NC	Type 'L' & 'NL' (Except LLGS / LPGS)	SP40S1	1545
Limit Switch Unit Assembly 2NO+2NC	Type 'L' & 'NL' (Except LLGS / LPGS)	SP40S2	2555
Limit Switch Unit Assembly 1NO+1NC	LLGS / LPGS	SP40S1WOM	1005
Oil tight Conduit	Type 'NL'	SP40CE	595

\* B = Button R = Roller





## AC Solenoid - Pull Type

GST to be charged extra

HSN Code : 8505

Type	Suitable for	Stroke Length mm	Max. Pull at rated voltage Kg.	Cat. No.	List Price [₹]
B	S-42	25.0	1.25	SLB■	5690
D	S-51, S-71 S-52, S-72	31.4	6.75	SLD■ SLD2■	8390
E	S-250	40	10	SPSLEM SPSLEB	18255

\* The standard coil voltages are 110, 220 & 415 V 50 Hz. AC

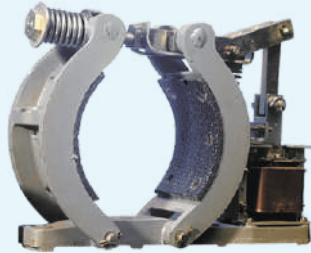

## AC Solenoid Brake - Type S

GST to be charged extra

HSN Code : 8505

Type of Brake	Wheel dia.		Max. Torque		Duty	Brake		Drum	
	Inch	mm	Lb. ft.	Nm		Cat No.	List Price [₹]	Cat No.	List Price [₹]
S-4	4	101.6	10	13.6	Continuous	S-42■	13400	AC50D4	2230
S-5	5.5	139.7	25	34.0	Continuous Intermittent	S-51■	19165	AC50D5	3080
			35	48.0		S-52■			
S-7	7	177.8	50	68.0	Continuous Intermittent	S-71■	21915	AC50D7	3735
			75	102.0		S-72■			
S-250	9.84	250	109	147.0	Continuous	S-2501M	47150	AC50D25	7550

- The standard coils are 110, 220 & 415 V 50 Hz. AC

■ To complete Cat. No. suffix voltage code given below

- Brake drums are of standard specification

### Range

- Solenoids:
  - Type : SLB - 25 mm stroke length
  - Type : SLD - 31.4 mm stroke length
- AC Brakes
  - 4" Dia
  - 5.5" Dia
  - 7" Dia
- Drums

### Features

- Class F insulation of the coil
- Continuous & Intermittent duty
- Long life & ease of maintenance
- Ideally suited for applications such as :
  - Cranes
  - Hoists
  - Machines
  - Valves
  - Conveyers

## AC Solenoid Brakes - Voltage Codes

Coil Voltage	110	220	415
AC	A	B	M

## Spares For AC Solenoid Brake

GST to be charged extra

HSN Code : 8505

Description	Brake Size : 4"		Brake Size : 5.5"		Brake Size : 7.0"		Brake Size : 250mm	
	Cat. No.	List Price [₹]	Cat. No.	List Price [₹]	Cat. No.	List Price [₹]	Cat. No.	List Price [₹]
Brake lining	SP50L1	1600	SP50L2	2370	SP50L3	3170	SP50L4	6205
Brake shoe Assembly*	SP50SA1	4650	SP50SA2	5995	SP50SA3	9880	SP50SA4	19900
Brake Coil -Continuous -Intermittent	SP50MC01■	2745	SP50MC21■ SP50MC22■	5455	SP50MC21■ SP50MC22■	5455	SP50MC31■	14405

\* Brake shoe assembly is with lining.

■ To Complete Cat. No. suffix voltage code is given in table, above.

**\*GST to be charged extra on all AC Brakes & Brake Spares**

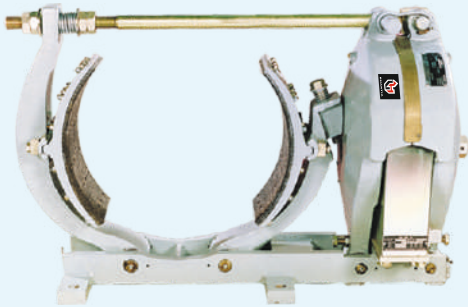

- Shunt and Series type versions in sizes :  
8 Inch to 30 Inch  
160 mm to 800 mm
- Conforms to NEMA and AISE Standards
- Fail safe operation
- Unique design for maximum torque and minimum shoe wear  
Brakes equivalent to Russian 'TK Π' design also available
- Resistance & rectifier Panel available with option of 'Fuse' or 'MCB' protection



### Optional Features

- Limit Switch Attachment
- Manual Release
- Residual magnetism adjustment



**GST to be charged extra**

**HSN Code : 8505**

### DC Electromagnetic Brakes

Drum Size	Cat No.	Shunt Type Torque		Resistance & Rectifier Panel (with fuse protection) <sup>+</sup>			
		Torque KG-M	List Price [₹]	Single Brake		2 Brakes Simult. Operation	
				Cat No.	List Price [₹]	Cat No.	List Price [₹]
150mm	SMH150	8	66185	CACS1*MAE	69280	CACS2*MAE	96230
160mm	SMH160						
8"/200mm	SMH8	13.8	77910	CACA1*MAE	77230	CACJ2*MAE	100075
	SMH200	13.8					
10"/250mm	SMH10	27.7	95640	CACB1*MAE	81945	CACK2*MAE	112650
	SMH250	27.7					
13"/300mm	SMH13	76.0	156570	CACC1*MAE	88360	CACL2*MAE	131175
	SMH300	76.0					
16"/400mm	SMH16	138.8	252020	CACD1*MAE	101740	CACM2*MAE	142545
	SMH400	138.8					
19"/500mm	SMH19	277.0	406290	CACE1*MAE	123020	CACN2*MAE	180095
	SMH500	277.0					
23"/600mm	SMH23	555.0	643015	CACF1*MAE	158615	CACP2*MAE	227850
	SMH600	555.0					
30"/700mm	SMH30	1242.0	1431925	CACG1*MAE	626175	-	-
	SMH700	1242.0					
800mm	SMH800	1242.0	1551415	CACG1*MAE	626175	-	-

\* For control supply i.e. A=110 V, B=220 V, K =240V and M=415 V AC

- DC Electromagnetic Brakes are suitable to operate on:  
For AC Power - Resistance & Rectifier Panel  
For DC Power - Series Resistance Box

+ For Panel with MCB protection use the suffix '- MCB'  
eg. For 200mm single operation brake panel with MCB protection,  
Cat code will be CACA1\*MAE-MCB

- All Brakes are Supplied for Continuous Duty
- Resistance & Rectifier Panel is supplied without transformer.
- Control Transformer (Optional) can be supplied at extra cost.  
Please add Rs. 8620/- per unit with the LP of Resistance & Rectifier Panel. Please add 'TR' with respective panel cat. ref. to obtain final cat. Code of such panel with control transformer.

**\*GST to be charged extra on all DC Brakes, Brake Spares, Resistance & Rectifier Panel & Resistance Boxes**



**GST to be charged extra**

**HSN Code : 8505**

## Resistance Boxes for DC Electromagnetic Brakes

Suitable for Shunt Type		Permanent Series Resistance Box for 230 V DC Supply For Single Brake		Permanent Series Resistance Box for 230 V AC Supply For Single Brake		Permanent Economy Resistance Box for 415 V AC Supply For Single Brake		Permanent Economy Resistance Box for 415 V AC Supply For Double Brake	
Cat No.	Torque KGM	Cat No.	List Price [₹]	Cat No.	List Price [₹]	Cat No.	List Price [₹]	Cat No.	List Price [₹]
SMH150 / SMH160	8	CDCS101D	8980	CARS10KE	8210	CARS10ME	16575	CARS20ME	On request
SMH8 / SMH200	13.8	CDCA101D CDIA101D*	9330	CARA10KE	8490	CARA10ME	16575	CARA20ME	On request
SMH10 / SMH250	27.7	CDCB101D CDIB101D*	11065	CARB10KE	9775	CARB10ME	16575	CARB20ME	On request
SMH13 / SMH300	76.0	CDCC101D CDIC101D*	12765	CARC10KE	11590	CARC10ME	18970	CARC20ME	25920
SMH16 / SMH400	138.8	CDCD101D CDID101D*	13665	CARD10KE	12460	CARD10ME	22050	CARD20ME	27230
SMH19 / SMH500	277.0	CDCE101D CDIE101D*	14630	CARE10KE	13350	CARE10ME	24470	CARE20ME	On request
SMH23 / SMH600	555.0	CDCF101D CDIF101D*	16660	CARF10KE	14995	CARF10ME	26300	CARF20ME	On request
SMH30 / SMH700	1242.0	CDCG101D CDIG101D*	40340	-	-	CARG10ME	45380	-	-
SMH800	1242.0	CDIG101D*	40340	-	-	CARG10ME	45380	-	-

1. DC Electromagnetic Brakes are suitable to operate on:  
For AC Power - Resistance & Rectifier Panel  
For DC Power - Series Resistance Box

- All Brakes are Supplied for Continuous Duty
- \* These cat. references are meant for intermittent duty

**\*GST to be charged extra on all DC Brakes, Brake Spares, Resistance & Rectifier Panel & Resistance Boxes.**

**GST to be charged extra**

## Series Type - DC Electromagnetic Brakes

HSN Code : 8505

Brake Size	Motor Frame No. (Max.)	Half Hour Rating			One Hour Rating			List Price [₹]
		Torque KGM	Max. FLC (A)	Cat. No.	Torque KGM	Max. FLC (A)	Cat. No.	
8"/200mm	402,802A	13.8	29	SME8H1 SME200H1	8.97	21	SME801 SME20001	160505
	403, 602, 802B		44	SME8H2 SME200H2		31	SME802 SME20002	On request
10"/250mm	404,603,802C,	27.7	57	SME10H1 SME250H1	18.0	40	SME1001 SME25001	228995
	406,604,803		77	SME10H2 SME250H2		57	SME1002 SME25002	On request
13"/300mm	408,606,804	76.0	126	SME13H1 SME300H1	49.4	95	SME1301 SME30001	310245
	410,608,806		176	SME13H2 SME300H2		132	SME1302 SME30002	On request
16"/400mm	412,610,808	138.8	245	SME16H1 SME400H1	90.2	185	SME1601 SME40001	485530
19"/500mm	414,612,810	277.0	368	SME19H1 SME500H1	180.0	272	SME1901 SME50001	745900
	416,614,812		500	SME19H2 SME500H2		360	SME1902 SME50002	On request
23"/600mm	418,616,814	555.0	740	SME23H1 SME600H1	361.0	540	SME2301 SME60001	1206775
	618,816		960	SME23H2 SME600H2		730	SME2302 SME60002	On request

















- During ordering, besides brake drum dia, please confirm duty rating, current rating & motor frame Nos.
- Above current ratings are for 230 V DC Series Motors.
- To convert KGM to LB.FT. multiply by 7.25

**\*GST to be charged extra on all DC Brakes, Brake Spares, Resistance & Rectifier Panel & Resistance Boxes.**

**GST to be charged extra**

## Series & Accessories - DC Electromagnetic Brakes

**HSN Code : 8505**

Description	150/160mm		8"/200mm		10"/250mm		13"/300mm	
	Cat No.	List Price [₹]	Cat No.	List Price [₹]	Cat No.	List Price [₹]	Cat No.	List Price [₹]
 Coil Shunt	9GDS01	47105	9GDA01	55780	9GDB01	67420	9GDC01	107030
 Coil Series for inch for mm	-	-	9GDA02/ 9GDA03	118835	9GDB02/ 9GDB03	186260	9GDC02/ 9GDC03	240880
 Torque Adj. Screw Assembly	9GDS04	4295	9GDA04	4490	9GDB04	4490	9GDC04	7805
 Torque Spring	9GDS05	11700	9GDA05	12215	9GDB05	14430	9GDC05	23360
 Wedge Assembly with Bolt, Spring and Washers for inch/mm	9GDS20/ 9GDS22	1670	9GDA20/ 9GDA22	1910	9GDB20/ 9GDB22	2220	9GDC20/ 9GDC22	3390
 Pin set for Lever & Armature Consisting of a) Pin Lever 2 Nos. b) Pin armature 2 Nos.	9GDS06	5900	9GDA06	6190	9GDB06	6190	9GDC06 9GDC06-2#	7805
 Coller Set of Lever & Armature Consisting of a) Coller Lever 4 Nos. a) Coller Armature 4 Nos.	9GDS07	5900	9GDA07	6190	9GDB07	6190	9GDC07	7420
 Bush Set for Lever & Armature Consisting of a) Bush Lever 4 Nos. a) Bush Armature 4 Nos.	9GDS08	11700	9GDA08	12265	9GDB08	12265	9GDC08	13365
 Pull Rod Assembly with nuts, spring & washer	9GDS29	4785	9GDA29	5005	9GDB29	6190	9GDC29	9515
Grease Nipple (1 set consist 8 Nos.)	9GDS09	1670	9GDA09	1770	9GDB09	1770	9GDC09	1790
 Shoe Assembly with Clamp & Bolts (1 set consist 2 Nos.) for inch/mm	9GDS10/ 9GDS11	12180	9GDA10/ 9GDA11	12130	9GDB10/ 9GDB11	15045	9GDC10/ 9GDC11	23685
 Shoe Lining without Bolts for inch for mm (1 set consist 2 Nos.)	9GDS12/ 9GDS13	4130	9GDA12/ 9GDA13	4295	9GDB12/ 9GDB13	5405	9GDC12/ 9GDC13	7805
 Shoe Lining with Bolts for inch for mm (1 set consist 2 Nos.)	9GDS23/ 9GDS26	5580	9GDA23/ 9GDA26	6190	9GDB23/ 9GDB26	7805	9GDC23/ 9GDC26	11150
 Dust Cover (made of jeans cloth & painted with fire reterdent al. paint).	-	-	9GDA30	6890	9GDB30	6890	9GDC30	8195
 mm Size Cast Steel Drum without Hard Chrome Plaiting	9GDS15/ (150mm) 9GDS14 (160mm)	13310	9GDA14	14650	9GDB14	22550	9GDC14	38000
 mm Size Cast Steel Drum with Hard Chrome Plaiting	9GDS15P/ (150mm) 9GDS14P (160mm)	17975	9GDA14P	20965	9GDB14P	32735	9GDC14P	55065
 Cast Steel Drum without Hard Chrome Plaiting* for inch	-	-	9GDA15	15190	9GDB15	23375	9GDC15	39515
 Cast Steel Drum with Hard Chrome Plaiting* for inch	-	-	9GDA15P	21800	9GDB15P	33540	9GDC15P	57305

\* For brakes manufactured upto September 07. # For brakes manufactured after September 07 (pins are different).

**\*GST to be charged extra on all DC Brakes, Brake Spares, Resistance & Rectifier Panel & Resistance Boxes.**

**GST to be charged extra**

## Spares & Accessories - DC Brakes

**HSN Code : 8505**

Description	16"/400 mm		19"/500 mm		23"/600 mm		30"/700 mm/800mm			
	Cat No.	List Price [₹]	Cat No.	List Price [₹]	Cat No.	List Price [₹]	Cat No.	List Price [₹]		
 Coil Shunt	9GDD01	162700	9GDE01	228430	9GDF01	358990	9GDG01	813325		
 Coil Series	for inch for mm	9GDD02 9GDD03	354410	9GDE02 9GDE03	462285	9GDF02 9GDF03	714605	- -		
 Torque Adj. Screw Assembly	9GDD04	11660	9GDE04	16625	9GDF04	26575	9GDG04	55665		
 Torque Spring	9GDD05	35895	9GDE05	49660	9GDF05	82235	9GDG05	176485		
 Wedge Assembly with Bolt, for inch for mm	9GDD20/ 9GDD22	4490	9GDE20/ 9GDE22	7275	9GDF20/ 9GDF22	10560	9GDG20/ 9GDG22	23390		
 Pin set for Lever & Armature Consisting of	for inch for mm	9GDD06* 9GDD06-2#	9515	9GDE06* 9GDE06-2#	9515	9GDF06* 9GDF06-2#	13365	9GDG06 <sup>++</sup>	40450	
 Collar Set of Lever & Armature Consisting of	a) Collar Lever 4 Nos. b) Collar Armature 4 Nos.	9GDD07	7420	9GDE07	7275	9GDF07	9095	9GDG07 <sup>+</sup>	14930	
 Bush Set for Lever & Armature Consisting of	a) Bush Lever 4 Nos. b) Bush Armature 4 Nos.	9GDD08	13675	9GDE08	14325	9GDF08	18335	9GDG08 <sup>++</sup>	32615	
 Pull Rod Assembly with nuts, spring & washer	9GDD29	14430	9GDE29	19955	9GDF29	26815	9GDG29	70150		
 Grease Nipple ( 1 set consist 8 Nos.)	9GDD09	1820	9GDE09	3135	9GDF09	3135	9GDG09	3465		
 Shoe Assembly with Clamp & Bolts for inch ( 1 set consist 2 Nos.)	for mm	9GDD10/ 9GDD11	35950	9GDE10/ 9GDE11	49730	9GDF10/ 9GDF11	79505	9GDG10/ 9GDG11	178925	
 Shoe Lining without Bolts	for inch ( 1 set consist 2 Nos.)	for mm	9GDD12/ 9GDD13	12235	9GDE12/ 9GDE13	19955	9GDF12/ 9GDF13	29525	9GDG12/ 9GDG13	55790
 Shoe Lining with Bolts	for inch ( 1 set consist 2 Nos.)	for mm	9GDD23/ 9GDD26	15045	9GDE23/ 9GDE26	24890	9GDF23/ 9GDF26	38670	9GDG23/ 9GDG26	68995
 Dust Cover (made of jeans cloth & painted with fire reterdent al. paint).	9GDD30	8865	9GDE30	10960	9GDF30	11500	-	-		
 mm Size Cast Steel Drum without Hard Chrome Plaiting	9GDD14	47510	9GDE14	77340	9GDF14	107560	-	-		
mm Size Cast Steel Drum with Hard Chrome Plaiting	9GDD14P	70730	9GDE14P	112975	9GDF14P	164545	-	-		
Cast Steel Drum without Hard Chrome Plaiting*	for inch	9GDD15	49550	9GDE15	80965	9GDF15	110510	-	-	
Cast Steel Drum with Hard Chrome Plaiting*	for inch	9GDD15P	73925	9GDE15P	118445	9GDF15P	172440	9GDG15P	292155	

\* For brakes manufactured upto September 07. # For brakes manufactured after September 07 (pins are different).  
+ Consist of strap, Brass Shim & spring Plate ++ Only for Armature +++ Suitable for 800mm

**\*GST to be charged extra on all DC Brakes, Brake Spares, Resistance & Rectifier Panel & Resistance Boxes.**

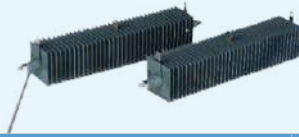

**GST to be charged extra**

## Spare Selenium Type Bridge Rectifiers

**HSN Code : 8505**

Rectifier Code / Part No.	Recommended to operate brake at 415V AC		Qty. per set	List Price [₹]
	Individual	Simultaneous		
9GDX01	1x8"/200mm	-	2	14490
9GDX02	1x10"/250mm	2x8"/200mm	2	21625
9GDX03	1x13"/300mm	2x10"/250mm	2	29285
	1x16"/400mm			
9GDX04	1x19"/500mm	2x13"/300mm	2	38670
		2x16"/400mm		
9GDX05	1x23"/600mm	2x19"/500mm	2	55150
9GDX06	-	2x23"/600mm	2	110350
9GDX07	1x30"/700 & 800mm	-	2	153015



**GST to be charged extra**

## Spare Resistances

**HSN Code : 8505**

Used in resistance and rectifier panels	Cat. No.	Ohms	Watts	List Price [₹]
CACA1*, CACB1*, CACC1*, CACD1*, CACJ2*	9GDX32	32	200	2570
CACA1*, CACB1*, CACC1*, CACF1*, CACG1*, CACL2*, CACP2*, CACJ2*	9GDX42	42	200	
CACS2*	9GDX47	47	200	
CACB1*, CACE1*, CACF1*, CACG1*, CACJ2*, CACK2*, CACM2*, CACN2*	9GDX52	52	200	
CACS1*	9GDX64	64	100	
CACA1*, CACB1*, CACD1*, CACE1*, CACF1*, CACG1*, CACJ2*, CACK2*, CACM2*, CACN2*, CACP2*	9GDX80	80	200	
CACA1*, CACD1*, CACK2*, CACL2*	9GDX112	112	200	
CACS1*, CACS2*	9GDX112A	112	125	

**GST to be charged extra**

## Optional Features - DC Brakes

**HSN Code : 8505**

Brakes Size		Manual Release List Price [₹]	Residual Magnetism Adjustment List Price [₹]	Limit Switch Attachment List Price [₹]	
Inch	mm			1NO+1NC (LSA)	2NO+2NC (LSA-2)
8	150/160/200	5730	11065	11655	
10	250	5730			
13	300	7855			
16	400	8425			
19	500	13080			
23	600	18330			

Note : Suffix following codes to complete brakes code with optional features.

- MR = For Manual Release
- RM = For Residual Magnetism
- LS = For Limit Switch (1NO+1NC)
- LS-1 = For Limit Switch (2NO+2NC)
- RR = For Manual Release + Residual Magnetism
- RL = Residual Magnetism + Limit Switch
- ML = For Manual Release + Limit Switch
- RS = For Manual Release + Residual Magnetism + Limit Switch

**To order Spare Limit Switch assembly, cat codes are:**

- LSA = Limit Switch with fitting Arrangement (1NO + 1NC)
- LSA-2 = Limit Switch (2NO + 2NC) with fitting Arrangement

**\*GST to be charged extra on all DC Brakes, Brake Spares, Resistance & Rectifier Panel & Resistance Boxes.**

## Pneumatic Timer



- 30 sec / 60 sec/180 sec
- AC and DC Supply
- 1 NO+1NC / 2 NO+2NC Contact Blocks
- Completely enclosed timing head ensures excellent timings in adverse environmental conditions
- Encapsulated coil for better resistance against moisture and corrosion
- Completely maintainable i.e Coil , Contact blocks and Timing head can be replaced
- Special timer for Railway application



## Pneumatic Timers Time Delay Relay-Electro Pneumatic

HSN Code : 9107

Type	Time Range (Secs.)	Contact Configuration		Cat No.	MRP [₹]	
		Time Block	Instantaneous Block		AC	DC
PN	0.05 - 30 Sec	1NO + 1NC	-	KRTPN10-0	5450	8170
	0.05 - 60 Sec	1NO + 1NC	-	KRTPN10-1	5640	8625
	0.05 - 180 Sec	1NO + 1NC	-	KRTPN10-3	6370	9405
	0.05 - 30 Sec	2NO + 2NC	-	KRTPN20-0	6125	8745
	0.05 - 60 Sec	2NO + 2NC	-	KRTPN20-1	6255	8850
	0.05 - 180 Sec	2NO + 2NC	-	KRTPN20-3	6725	9505
PNI	0.05 - 30 Sec	1NO + 1NC	1NO + 1NC	KRTPN11-0	6645	9510
	0.05 - 60 Sec	1NO + 1NC	1NO + 1NC	KRTPN11-1	7540	10385
	0.05 - 180 Sec	1NO + 1NC	1NO + 1NC	KRTPN11-3	8250	10510
	0.05 - 30 Sec	2NO + 2NC	2NO + 2NC	KRTPN22-0	8330	10850
	0.05 - 60 Sec	2NO + 2NC	2NO + 2NC	KRTPN22-1	8420	11415
	0.05 - 180 Sec	2NO + 2NC	2NO + 2NC	KRTPN22-3	9025	12075
Type	Time Range (Secs.)	On-Delay Block	Of-Delay Block	Cat No.	AC	DC
PCN	0.05 - 30 Sec	1NO + 1NC	1NO + 1NC	KRTPCN11-0	9000	12050
	0.05 - 60 Sec	1NO + 1NC	1NO + 1NC	KRTPCN11-1	9450	12150
	0.05 - 180 Sec	1NO + 1NC	1NO + 1NC	KRTPCN11-3	10735	13425
	0.05 - 30 Sec	2NO + 2NC	2NO + 2NC	KRTPCN22-0	10115	13225
	0.05 - 60 Sec	2NO + 2NC	2NO + 2NC	KRTPCN22-1	10600	13380
	0.05 - 180 Sec	2NO + 2NC	2NO + 2NC	KRTPCN22-3	11955	14590

PN, PNI Time Delay Relay will be supplied only as on-delay

- To complete Cat. No. Suffix Voltage code from Table

## Timer for Railway Application

HSN Code : 9107

Type	Time (Secs.)	Contact Configuration		Cat No.	MRP [₹]	
		Time Block	Instantaneous Block		AC	DC
PN	120	2NO + 2NC	-	KRTPN20A-2R	6555	-
	150	2NO + 2NC	-	KRTPN20A-3R	6555	-

## Accessories for Time Delay Relay HSN Code : 9107

Description	Cat. No.	MRP [₹]	Lot Size
Contact Block			
1NO+1NC Timed	SP20S3+	1200	1
2NO+2NC Timed	SP20S4+	1565	
1NO+1NC Inst.	SP20S5+	1200	
2NO+2NC Inst.	SP20S6+	1565	
Magnet Coil			
AC-PN Relays	SP20MC	1685	1
AC-PNI & PCN Relays	SP20MC1	1685	
DC Relays	SP20MC2	5455	
Return Spring*	SP20RS	285	1
(PNI & PCN) Coil Clip*	SP20CC	455	
Magnet frame assembly without coil	SP20 MAIMA1	2455	1
Knob assembly	SP20KA	85	10

\* These are supplied with plastic cover

\* For DC Timers only

- To complete suffix voltage code refer to the table

- High Repeat Accuracy
- Operating Temperature - 40<sup>0</sup> to +65<sup>0</sup>
- Mechanical and Electrical Life - 10 million operations

## Voltage Suffix Code

Coil Voltage	24	110	220	240	415
AC Suffix Code*	*	A	B	K	M
DC Suffix Code	U1	*	B1	K1	-

\* KRTPN timers with 24V AC, 110V DC & 550V AC coil voltage, Prices available on request



## Punched Grid Resistors

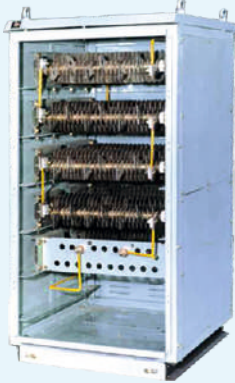

### Applications:

- Speed Control Resistors
- Starting Resistors for AC and DC Motors
- Dynamic Braking Resistors
- Neutral Grounding Resistors (upto 11KV)

### Features

- Special Chromium Steel Alloy (AISI406) for :
  - a) Higher resistivity (approx 70% higher than others)  
This results in overall light and compact unit
  - b) Low temperature coefficient (approx 72% lower than others)  
This means negligible change in resistance values despite grid temperature variations (very important parameter in applications like crane controls)
  - c) Unbreakable and corrosion free Grids . Suitable for extreme vibration conditions
  - d) Drawout type of banks for ease of removal while replacements
  - e) Three rod construction for higher range resistance grid for improved mechanical strength
  - f) Individual grids are T.I.G. welded for consistent current path
  - g) Unique design using staggered grid pattern ensuring maximum air circulation
  - h) Terminal designed for 2 types of conductors ensuring flexibility

We also manufacture NGRs & DBRs

## GST to be charged extra on PGR Prices

PGRs are 10 minutes rated.

Temp. rise : 375 deg over ambient

Dimensions in mm (WxHxD) : 673x152x250 HSN Code - 8533

Type	Resistance Per Bank	Continuous Rating	LP
	Ohms	Amps	[₹]
WL10	0.1	225	24295
WL12	0.125	200	21490
WL16	0.16	180	24830
WL20	0.2	150	25350
WL25	0.25	134	22385
WL32	0.32	118	19815
WL40	0.4	113	22920
WL50	0.5	100	19360
WL62	0.62	84	24990
WL80	0.8	75	22645
WL100	1	67	21050
WL125	1.25	64	23430
WL160	1.6	57	20220
WL200	2	54	22505
WL250	2.5	48	19870
WL320	3.2	43	17405
WL400	4	40	24240
WL500	5	35	17590
WL625	6.25	33	20090
WL800	8	29	18745
WL1200	12	21	20090
WL1600	16	19	19490

Dimensions in mm (WxHxD) : 800x152x250 HSN Code - 8533

Type	Resistance Per Bank	Continuous Rating	LP
	Ohms	Amps	[₹]
WLL20(M)-1	0.325	150	39415
WLL25(M)-1	0.54	134	37685
WLL32(M)-1	0.68	118	31955
WLL50(M)-1	0.864	100	27080

# ACB's, MCCB's & FDP Products



**ULTRA**  
**POWER**  
Air Circuit Breakers

## Ultra Power ACB's

- Range: 800A to 6300A in 3 frames
- Complete range conforms to IS/IEC 60947-2
- Manually & Electrically operated, Fixed/Draw-out versions
- Microprocessor based releases in basic & advance version
- $I_{cu}=I_{cs}=I_{cw}$  for 1 sec for total selectivity
- Modular & snap-fit accessories
- RoHS Compliant



## X-Range MCCB's



- 3P range: 10A-1250A
- 4P range: 20A-1250A
- Breaking Capacity : 10kA to 50kA
- Tested & Certified as per IS/IEC-60947-2
- Available in Thermal Magnetic & Microprocessor based (LSI & LSI) releases



## FDP Products

MCB, RCCB, Isolator & Distribution Boxes

For above products, please refer "Control & Switchgear Products" price list

# Controlgear



- FREEDOM CONTACTORS
- CITATION SERIES
- AGRI CONTACTORS
- CAPACITY DUTY CONTACTORS
- DEFINITE PURPOSE CONTACTORS

- **Contactors**
- **Overload Relays**
- **Electronic Over Current Relay**
- **Motor Protection Circuit Breaker**
- **Solid State Relay**
- **Push Buttons & Indicating Lights**

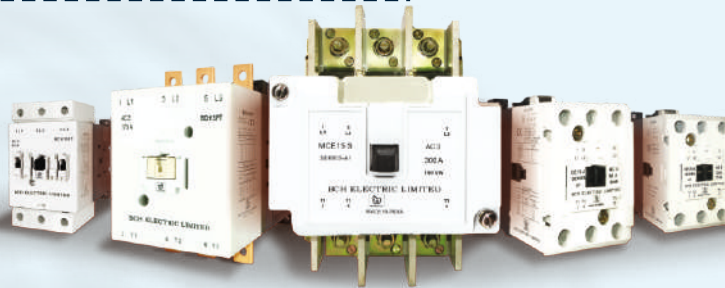

For above products, please refer "Control & Switchgear Products" price list

# Motor Starters

## Shakti DOL & Star Delta Starters



- DOL & Star Delta upto 24 A relay range
- Heavy duty 4 Pole Contactor
- Wide Band coil voltages (190-400V, 230-420V, 220-240V, 380-415V)
- Encapsulated & Hermetically sealed coil
- Automatic star delta with electronic timer for reliable changeover from star to delta
- Selection of manual & auto resetting of overload relay



**BCH**

## Citation DOL & Star Delta Starters

- Citation DOL & Star Delta Starters
- DOL upto 40 HP
- Semi Automatic upto 40 HP
- Fully Automatic upto 375 HP
- Heavy Duty 4 Pole Contactor
- Wide Band Coil Voltage (230-360V, 260-400V, 380-415V)
- Automatic Star Delta with Electronic Time for Reliable Changeover from Star to Delta
- Selection of Manual & Auto Resetting of Overload Relay



## Shakti & Citation P Auto DOL starters

Parameter	Shakti Auto DOL	Citation P Auto DOL
Range	Upto 24A Relay	Upto 40A Relay or 22.5 HP
ON delay time	5 sec or 5 min option	5 sec to 5 min (Field adjustable)
Mode of operation	Auto/Manual/Manual SPP with selector switch	SPP with integrated Auto/Manual SPP/ Bypass selector switch
Protections	Phase reversal, Phase imbalance & Single phasing	

## BK1 DOL & Semi Automatic Star Delta starters



- Range: DOL upto 7.5 H.P
- Range: Star Delta upto 15 H.P
- Wide Band Coil 250-400 V AC & 200-400 VAC

- Starter With 2 Pole CPGN Contactor and 2 Pole Overload Relay
- Encapsulated & Hermetically Sealed Coil
- Selection of Manual & Auto Resetting of Overload Relay
- Power Coated Deep Drwan Sheet Steel Enclosure for Excellent Finish & Durability

## 1-Phase DOL Starter



## Mini Manual Starters



- Range Available upto 10 HP (3PH) & upto 3HP (1PH)
- Flush & Base Mounting Version Available
- Trips Automatically in Low Voltage Conditions (with UV Coil)
- Prevents Motor From Restarting When Powder Comes Back

For above products, please refer "Control & Switchgear Products" price list

# Enclosure Systems



- Bhartia Boxes IP: 55, IP: 66
- 'BCH-SS' (Stainless Steel) Boxes
- Terminal Boxes IP:55 & IP:66
- Techno - Modular Enclosures
- TCE Series Enclosure
- Compartmentalized Enclosure (Fixed & Draw-out)
- IT Racks - 19" and ETSI Racks



For above products, please refer "Enclosures" price list

# Motors



## IE2, IE3 & IE4

50°C  
ambient temperature

Class F



- 0.12 HP to 425 HP
- 2 to 8 Poles
- With forced cooling
- Upto 40 intermediate standard ratings
- High efficiency, consistent - life long
- Low loss for entire life
- Inverter duty motor
- No deration upto 50° C
- Dual coat winding wire as standard feature
- 6 terminals across the range
- Top, LHS, RHS termination flexibility
- ISI marking

For above products price list, please contact nearest BCH sales office.

# Power Factor Control Products



- LT Power Capacitors - Cylindrical Type
- LT Power Capacitors - Box Type
- Freedom Series Capacitor Duty Contactor
- Super Heavy Duty Box Type Capacitor
- Detuned Reactors
- Thyristor Switched Module
- Automatic Power Factor Controllers (APFC) & Intelligent Power Factor Controllers (IPFC)
- Network Analysers
- APFC Panels



For above products, please refer "Control & Switchgear Products" price list

# Automation Products



- AC Drives
- Digital DC Drives
- Soft Starters
- e-prox Sensors
- Plug-in Relays
- Electronic Timers



For above products, please refer "Control & Switchgear Products" price list



# Custom Built Products



- MCC & PCC
- APFC Panels
- Crane Control Panels
- Punch Grid Resistors & Panels, NGR & DBR
- Special Purpose Starters
- Power Receptacles
- Auto Transformer Starters





**BCH**

# Price List

## General Terms & Conditions

Prices are subject to change without any prior notice and will be applicable as prevailing at the time of dispatch.

- The prices are ex-works basis..
- The prices given in this list are effective as on date and are subject to change without notice.
- The List Prices (LP) mentioned are exclusive of GST.
- The duties, taxes and other statutory levies are based on rates prevailing at the time of billing. Any subsequent revision of those rates having retrospective effective shall be to customer's account.
- In case where any GST exemption has been claimed, the purchaser is responsible for providing the necessary GST exemption form within the specified period, failing which the purchaser would be liable for the payment of full GST plus applicable interest and penalties
- All Prices are in Indian Rupees (₹).
- Alteration made after receipt of confirmation of order are subject to price & delivery revisions and any other expenses or levies
- The dispute, if any, will be resolved mutually by discussion. However, if no settlement is forthcoming then, the Courts at New Delhi shall only have territorial jurisdiction to hear and decide the dispute.

## Warranty

All products, unless specifically mentioned otherwise, shall have warranty, against manufacturing defects for a period of 18\* months from the date of invoicing & 24 months from date of manufacturing whichever is later subject to the provision of proper usage and does not cover defects arising out of fire, accident, inefficient maintenance, faulty operation and willful or accidental damage. The manufacturer shall not be liable for any consequential loss, injury or damages attributable to defect or failure of its products.

\* Proof of purchase to be retained to avail warranty.

a strong commitment  
to serve better  
always ...



**Switchgear | Controlgear | Enclosures | Motor Starters & Submersible Pump Starters |  
Brakes and Crane Controls | MCC | PCC | Customised Solutions | Automation |  
Wires & Cables | Motors | Reactive Power Management**



**BCH  
ELECTRIC  
LIMITED**

[www.bchindia.com](http://www.bchindia.com)

- Power Control Products
- Starters & Submersible Pump Starters
- Industrial Enclosures
- Industrial Products
- Wires & Cables
- Motor Control Products
- Power Bus Duct
- Customised Solution
- Automation



# BCH ELECTRIC LIMITED



[www.bchindia.com](http://www.bchindia.com)



**1800-103-9262**

[customercare@bchindia.com](mailto:customercare@bchindia.com)

Visit us at : [www.bchindia.com](http://www.bchindia.com)

**Registered & Corporate Office :** 1105, New Delhi House, 27, Barakhamba Road, New Delhi - 110 001 Tel. : 91-11- 43673100

**CIN :** U31103DL1965PLC425953, **Customercare No.** 1800-103-9262, **E-mail :** [marketing@bchindia.com](mailto:marketing@bchindia.com)

**Works 1 :** 20/4, Mathura Road, Faridabad -121 006 (Haryana) Tel. : 0129-4063000/4293000 Fax : 0129-2304016

**Works 2 :** 64-68, Sector-7, IIE, Pant Nagar, Rudrapur, Udham Singh Nagar - 263 153 (Uttarakhand) Tel. : 05944-250214/16 Fax : 05944-250215

**Sales Offices :**

**Ahmedabad**  
401, Shilp Zeveri,  
Beside Shyamal Iconic,  
Above Westside,  
Shyamal Cross Road,  
Ahmedabad - 380015  
**Tel. : 079-46047740**  
E-mail: [ahmedabad@bchindia.com](mailto:ahmedabad@bchindia.com)

**Bangalore**  
2nd Floor, 130/5,  
K.H. Road (Double road),  
Bangalore - 560 027  
**Tel.: 080-41144879 / 22236759**  
E-mail : [bangalore@bchindia.com](mailto:bangalore@bchindia.com)

**Bhubaneswar**  
Mallick Commercial  
Complex Plot No. -A/69, unit - 3  
Bhubaneswar - 751 001  
**Tel.: 0674-3594970**  
E-mail.: [bhubaneswar@bchindia.com](mailto:bhubaneswar@bchindia.com)

**Chandigarh (Panchkula)**  
SCO -270, 2nd Floor,  
Sector-16, Panchkula  
Haryana-134 113  
**Tel.: 0172-5078957 / 5049905**  
E-mail.: [chandigarh@bchindia.com](mailto:chandigarh@bchindia.com)

**Chennai**  
Flat No. 3A, 3rd Floor,  
Sree Apartments,  
No.508, TTK Road,  
Alwarpet, Chennai 600 018  
**Tel.: 044-24337046, 24337047**  
E-mail : [chennai@bchindia.com](mailto:chennai@bchindia.com)

**Coimbatore**  
87, Dr. Nanjappa Road,  
Coimbatore - 641 018  
**Tel. : 0422-2305311 / 2302599**  
E-mail : [coimbatore@bchindia.com](mailto:coimbatore@bchindia.com)

**Delhi 1**  
801, Akash Deep Building,  
26A, Barakhamba Road,  
New Delhi - 110 001  
**Tel. : 011-23313878**  
E-mail : [delhi@bchindia.com](mailto:delhi@bchindia.com)

**Delhi 2**  
710, Deepali Building, 92  
Nehru Place, New Delhi - 110 019  
**Tel. : 011-45720334**  
E-mail : [delhi2@bchindia.com](mailto:delhi2@bchindia.com)

**Dehradun**  
8, Co-operative Industrial Estate,  
Patel Nagar, Dehradun-248001  
E-mail : [dehradun@bchindia.com](mailto:dehradun@bchindia.com)

**Faridabad**  
20/4, Mathura Road,  
Faridabad - 121 006 (Haryana)  
**Telfax : 0129-4293009**  
E-mail : [faridabad@bchindia.com](mailto:faridabad@bchindia.com)

**Hyderabad**  
1-8-303/48/13/102, Arya One,  
2nd Floor, P. G. Road,  
Secunderabad - 500 003  
**Tel. : 040-66206263/**  
**Fax : 040-66207273**  
E-mail : [hyderabad@bchindia.com](mailto:hyderabad@bchindia.com)

**Indore**  
330-331, Indraprastha Tower,  
3rd Floor, 6, M.G. Road,  
Indore - 452 001  
**Tel. : 0731-2510011 / 2510012**  
E-mail : [indore@bchindia.com](mailto:indore@bchindia.com)

**Jaipur**  
25, Hathroi, Gopalbari,  
Jaipur - 302 001  
**Tel. : 0141-2363521**  
E-mail : [jaipur@bchindia.com](mailto:jaipur@bchindia.com)

**Jamshedpur**  
A.J. Tower, 2B,  
2nd Floor, R-Road, Bistupur,  
Jamshedpur - 831 001  
**Tel. : 0657-2321097**  
E-mail : [jamshedpur@bchindia.com](mailto:jamshedpur@bchindia.com)

**Kolkata**  
Block 1E, 216,  
Acharya Jagadish Chandra Bose Road,  
Kolkata - 700 017  
**Tel. : 033-22871728 / 46021884**  
E-mail : [kolkata@bchindia.com](mailto:kolkata@bchindia.com)

**Lucknow**  
Shop No.3, 1st Floor,  
Tower T-10, Millennium Place,  
IBS-2, Sushant Golf city,  
Lucknow Road,  
Lucknow - 226 030  
E-mail : [lucknow@bchindia.com](mailto:lucknow@bchindia.com)

**Ludhiana**  
S.C.O.- 18, 2nd Floor,  
Feroze Gandhi Market,  
Ludhiana - 140 001  
**Tel. : 0161-5021807/5022808**  
E-mail : [ludhiana@bchindia.com](mailto:ludhiana@bchindia.com)

**Madurai**  
12, Parvathi Plaza-3rd Floor  
70 Feet Road, Ellis Nagar  
Madurai - 625016, Tamilnadu  
**Tel. : 0452-4564830**

**Mumbai**  
A-151, Mittal Tower,  
Nariman Point,  
Mumbai - 400 021  
**Tel. : 022-22850162**  
E-mail : [mumbai@bchindia.com](mailto:mumbai@bchindia.com)

**Pune**  
A- 605, 6th Floor,  
Kumar Surabhi Building,  
Pune Satara Road, Opp. Sai  
Baba Temple, Pune - 411 009  
E-mail : [pune@bchindia.com](mailto:pune@bchindia.com)

**Raipur**  
6th Floor, Office No. 607,  
Babylon Capital, Near Oswal  
Patrol Pump, VIP Chowk,  
G.E. Road, Raipur - 492 006  
**Tel. : 0771- 4020213**  
E-mail : [raipur@bchindia.com](mailto:raipur@bchindia.com)

**Vadodara**  
301, Third Floor, "Florence Classic",  
10, Ashapuri Co-Op. Hsg. Soc. Ltd., Opp. VUDA Housing,  
Near Cow Circle, Akota, Vadodara - 390 020  
**Tel. : 0265-2345068**  
**Telefax : 0265-2345068,**  
E-mail : [vadodara@bchindia.com](mailto:vadodara@bchindia.com)

**Other Branch Locations**

**Cochin :** [cochin@bchindia.com](mailto:cochin@bchindia.com), **Guwahati :** [guwahati@bchindia.com](mailto:guwahati@bchindia.com), **Vishakapatnam :** [vizag@bchindia.com](mailto:vizag@bchindia.com), **Surat :** [surat@bchindia.com](mailto:surat@bchindia.com), **Trichy :** [Trichy@bchindia.com](mailto:Trichy@bchindia.com)

**Resident Engineer Locations**

Anantapur	Jodhpur	Madurai	Rajkot	Siliguri
Aurangabad	Jalandhar	Muzaffarnagar	Rajahmundry	Tirunelveli
Bhopal	Kanpur	Nagpur	Ranchi	Udaipur
Calicut	Katni	Nashik	Rourkela	Vapi
Gurgaon	Kharagpur	Nanded	Rudrapur	Vijayawada
Hosapate	Kota	Patna	Salem	Warangal
Hubli	Kolhapur	Puducherry	Satna	Yamuna Nagar