

PRICE LIST

Effective From 15.6.2024

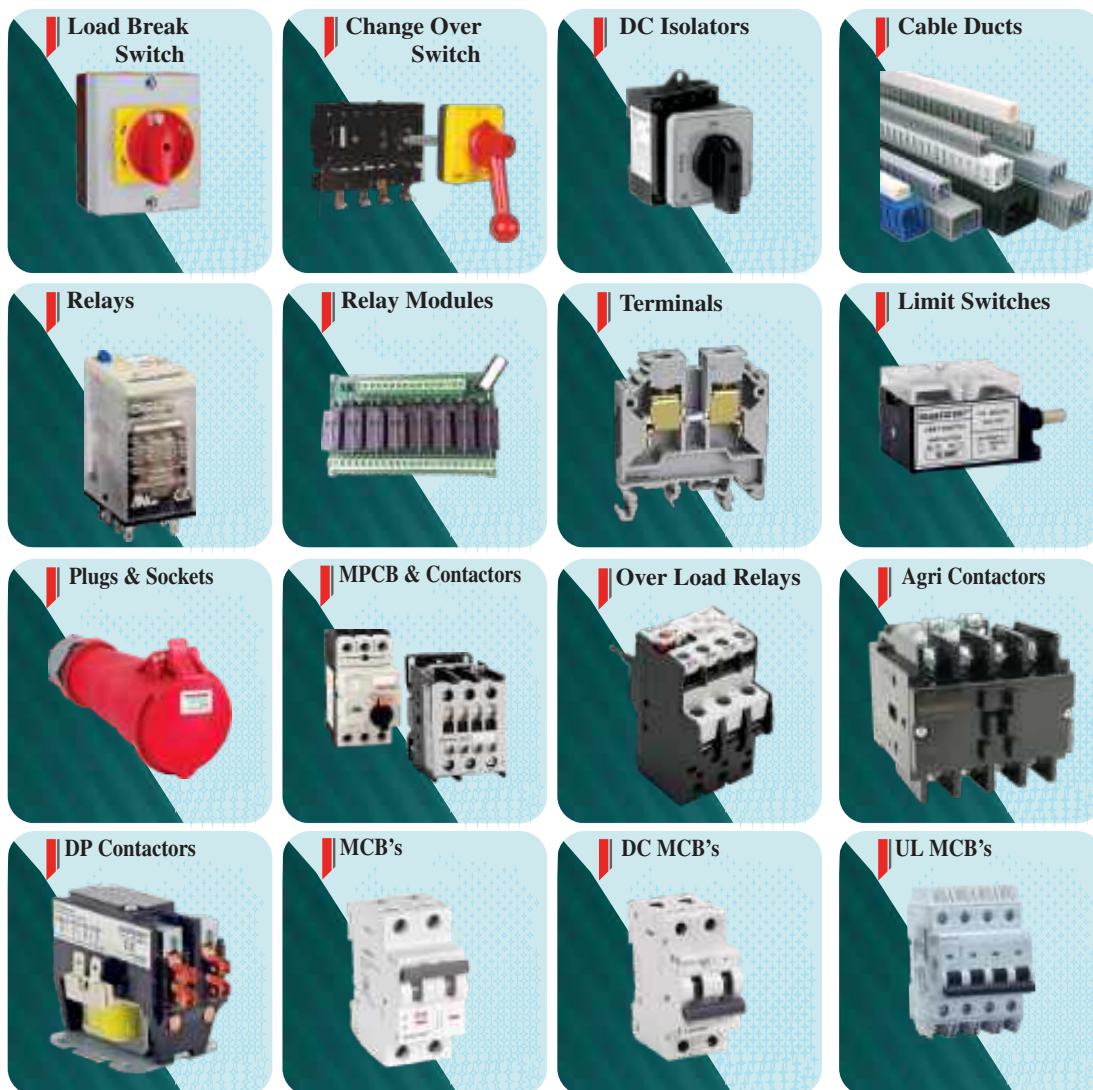



salzer

Established in 1985 in a time-bound collaboration with Saelzer Schaltegerate Fabrik GmbH to manufacture rotary switches, and headquartered in Coimbatore, Salzer has grown into an independent multi-product entity with a wide basket of Electrical Products, covering a variety of applications for the Domestic, Industrial & Automobile segments.

With a wide network and business association with a major engineering conglomerate on specific product ranges in domestic market, Salzer products are also available as a preferred choice in over 40 countries worldwide.



Contents

Panel Accessories

Load Break Switches	4
DC Isolators & Changeover	7
Cable Ducts	8
Relay & Relay Modules	10
ACCL	16
Terminal Connectors	17
Limit Switches	22
Plugs & Sockets	24

Motor Control Products

Contactors	29
Mini Contactors	30
Accessories - STD Contactors	31
Accessories - Mini Contactors	33
Overload Relays	35
Motor Protection Circuit Breakers (MPCB)	36
Accessories - MPCB	37
MCB-ISI	39
RCCB	41
DC MCB / Solar Combo	42
MCB-UL	43
Agri Contactors	45
Definite Purpose (DP) Contactors	46

GST 18%



For Rotary Switch Prices - Refer



Price List

Load Break Switches

AC ON LOAD ISOLATORS (8536)

- AC23 Utilization Category
- Range from 16-125 Amps upto 8 pole
- Multiple mounting options, ABS/ Aluminium/ sheet steel enclosures / IP65 / NEMA Rated
- Add on pole Power / Neutral and Auxiliary pole
- **Changover switches from 25-125 Amps upto 4 poles**
Confirms to IEC 60947-1 & 3, EN 60947- 3, UL60947-4-1



B03

Panel Mounting



MB34

Door Interlock Mounting



B31SM

Enclosure Mounting

LOAD BREAK SWITCHES

LB 3 Pole ON - OFF Switches

Description	Cat. No.	Can also be given on request	M.R.P. (₹) Per Unit								
			16A	20A	25A	32A	40A	63A	80A	100A	125A
Single Hole MTG Switch with Flag Knob	LBX32300B19FPYR		814	831	*	*	*	*	*	*	*
Front Panel MTG with Flag Knob	LBX32300B40FPYR		792	814	*	*	*	*	*	*	*
Front Panel MTG with B03 (48x48) Plate	LBX32300B03FLYR	32309	724	741	803	831	954	1024	*	*	*
Front Panel MTG with B13 (64x64) Plate with Flag Knob	LBX32300B13FLYR	32306 / 32309	724	741	803	831	954	1024	2589	3248	4079
Front Panel MTG with B13 (64x64) Plate with BG Handle	LBX32300B13BGYR	32309	*	*	882	913	1033	1092	*	*	*
DIN Rail MTG Switch with Flag Knob	LBX32300B23FLGB		*	*	803	831	954	1024	*	*	*
Rectangular Pad Lock Switch with TDYR	LBX32300B30TDYR		*	*	971	1024	1123	1181	*	*	*
Round Pad Lock Switch with RDYR	LBX32309B33RDYR		792	813	882	913	1033	1092	2807	3503	4378
Switch with B63 Lock & Key Version	LBX32309B63TDYR		*	*	1342	1403	1520	1561	*	*	*
Base MTG Switch with DIL and Pad Lock	LBX32309MB34RDYR		1264	1303	1403	1480	1542	1660	3739	4668	5836
Base MTG Switch with BG Handle	LBX32309MB42BGYR		1264	1303	1403	1480	1542	1660	3739	4668	5836
Switch in Polycarbonate Enclosure - in B31SM	LBX32300B31SMRDYR		1604	1652	1784	1830	*	*	*	*	*
Switch in Polycarbonate Enclosure - in B31M	LBX32309B31MRDYR		*	*	*	*	2001	2052	*	*	*
Switch in Polycarbonate Enclosure - in B31L with Leech Handle	LBX32309B31LLHYR		*	*	*	*	*	*	5266	6207	7365
Switch in SS Enclosure - in SB31L with Leech Handle	LBX32309SB31LLHYR		*	*	*	*	*	*	5266	6207	7365

LB 4 Pole ON - OFF Switches

Description	Cat. No.	Can also be given on request	M.R.P. (₹) Per Unit								
			16A	20A	25A	32A	40A	63A	80A	100A	125A
Single Hole MTG Switch with Flag Knob	LBX32400B19FPYR		1011	1033	*	*	*	*	*	*	*
Front Plate MTG with Flag Knob	LBX32400B40FPYR		993	1011	*	*	*	*	*	*	*
Front Panel MTG with B03 (48x48) Plate	LBX32400B03FLYR	32409	922	943	1025	1053	1233	1303	*	*	*
Front Panel MTG with B13 (64x64) Plate with Flag Knob	LBX32400B13FLYR	32406 / 32409	922	943	1025	1053	1233	1303	3178	3987	4996
Front Panel MTG with B13 (64x64) Plate with BG Handle	LBX32400B13BGYR	32409	*	*	1104	1134	1313	1373	*	*	*
DIN Rail MTG Switch with Flag Knob	LBX32400B23FLGB		*	*	1025	1053	1233	1303	*	*	*
Rectangular Pad Lock Switch with TDYR	LBX32400B30TDYR		*	*	1191	1242	1400	1463	*	*	*
Round Pad Lock Switch with RDYR	LBX32409B33RDYR		993	1011	1104	1134	1313	1373	3248	4055	5069
Switch with B63 Lock & Key Version	LBX32409B63TDYR		*	*	1561	1623	1799	1841	*	*	*
Base MTG Switch with DIL and Pad Lock	LBX32409MB34RDYR		1463	1502	1623	1700	1823	1942	4330	5406	6755
Base MTG Switch with BG Handle	LBX32409MB42BGYR		1463	1502	1623	1700	1823	1942	4330	5406	6755
Switch in Polycarbonate Enclosure - in B31SM	LBX32400B31SMRDYR		1799	1852	2001	2050	*	*	*	*	*
Switch in Polycarbonate Enclosure - in B31M	LBX32409B31MRDYR		*	*	*	*	2279	2331	*	*	*
Switch in Polycarbonate Enclosure - in B31L with Leech Handle	LBX32409B31LLHYR		*	*	*	*	*	*	5858	6944	8286
Switch in SS Enclosure - in SB31L with Leech Handle	LBX32409SB31LLHYR		*	*	*	*	*	*	5858	6944	8286
Auxiliary Contact	FM / RM		204	204	250	250	250	250	741	741	741
Add-on Contact Additional Pole	FM / RM		209	218	235	263	306	330	865	1068	1189

EB - GEN Changeover Switches (8536)



B13 Mounting



MB42 Mounting



SB31 Enclosure

3 Pole EB - GEN Changeover Switches

Description	Cat. No.	M.R.P. (₹) Per Unit						
		25A	32A	40A	63A	80A	100A	125A
3 Pole C/O Front Panel Mounting	EBX31153B13BGYR	2372	2470	2881	2998	*	*	*
3 Pole C/O Rear Mounting	EBX31153MB42BGYR	2751	2851	3319	3422	6117	7653	9560
3 Pole C/O in SS Enclosure	EBX31153SB31BGYR	3290	3379	3911	4027	*	*	*
3 Pole C/O Rear Mounting	EBX31153B21BGYR	2751	2851	3319	3422	6117	7653	9560
3 Pole C/O Rear Mounting	EBX31153MB34LHYR	2751	2851	3319	3422	6117	7653	9560
3 Pole C/O in Polycarbonate Enclosure	EBX31153B31LBGYR	3290	3379	3911	4027	*	*	*
3 Pole C/O in SS Enclosure	EBX31153SB31XLLHYR	*	*	*	*	8645	10170	12077

4 Pole EB - GEN Changeover Switches

Description	Cat. No.	M.R.P. (₹) Per Unit						
		25A	32A	40A	63A	80A	100A	125A
4 Pole C/O Front Panel Mounting	EBX31154B13BGYR	2751	2851	3379	3478	*	*	*
4 Pole C/O Rear Mounting	EBX31154MB42BGYR	3099	3219	3800	3972	7715	9653	12058
4 Pole C/O in SS Enclosure	EBX31154SB31BGYR	3668	3810	4420	4577	*	*	*
4 Pole C/O Rear Mounting	EBX31154B21BGYR	3099	3219	3800	3956	7715	9653	12058
4 Pole C/O Rear Mounting	EBX31154MB34LHYR	3099	3219	3800	3956	7715	9653	12058
4 Pole C/O in Polycarbonate Enclosure	EBX31154B31LBGYR	3668	3810	4420	4577	*	*	*
4 Pole C/O in SS Enclosure	EBX31154SB31XLLHYR	*	*	*	*	10241	12166	14586

Ordering Code for Load Break and Changeover Switches

LB Load Break Switch	EB EB Changeover Switch	X Current Rating	XXXXX Programme Code	XXXXX Mounting Options	XX Knob Options	XX Colour
------------------------------	------------------------------------	--------------------------	------------------------------	--------------------------------	-------------------------	-------------------

Example

LB Switches, 63A, 3P, 9 O'clock, 4 hole front mounting, with metal shaft, yellow front plate, red round knob

LB I 32309 MB34 RDYR

LB	I	32309	MB34	RD	YR	Description
—	—	—	—	—	—	Yellow Front Plate/Red Knob
—	—	—	—	—	—	64 x 64 Front Plate Round Knob with Padlock (R)
—	—	—	—	—	—	Metal Shaft with Round Knob with Padlock and Interlock
—	—	—	—	—	—	3Pole 9 O' Clock "OFF"
—	—	—	—	—	—	63A
—	—	—	—	—	—	Load Break Switch

Accessories

X F-Front Mounting	XX MC-Main Module	X 20 - 16A to 20A 32 - 25A to 32A 63 - 40A to 63A 80 - 80A 125 - 100A, 125A & 80A
R-Rear Mounting	NC-Neutral Module	
	AC-Auxiliary Module	

R	NC	32	Description
—	—	—	32A
—	—	—	Neutral Module
—	—	—	Rear Mounting

Rating Selection Table

Ampere (A)	16	20	25	32	40	63	80	100	125
Code (X)	C	D	E	F	G	I	J	K	L

Note : SB31 Enclosure for 25A to 63A ratings, SB31XL Enclosure for 80A to 125A ratings B21 Mounting model is similar to B13 model with links provided on the common side.

*Note : Not able to offer

DC Changeover

Application - I

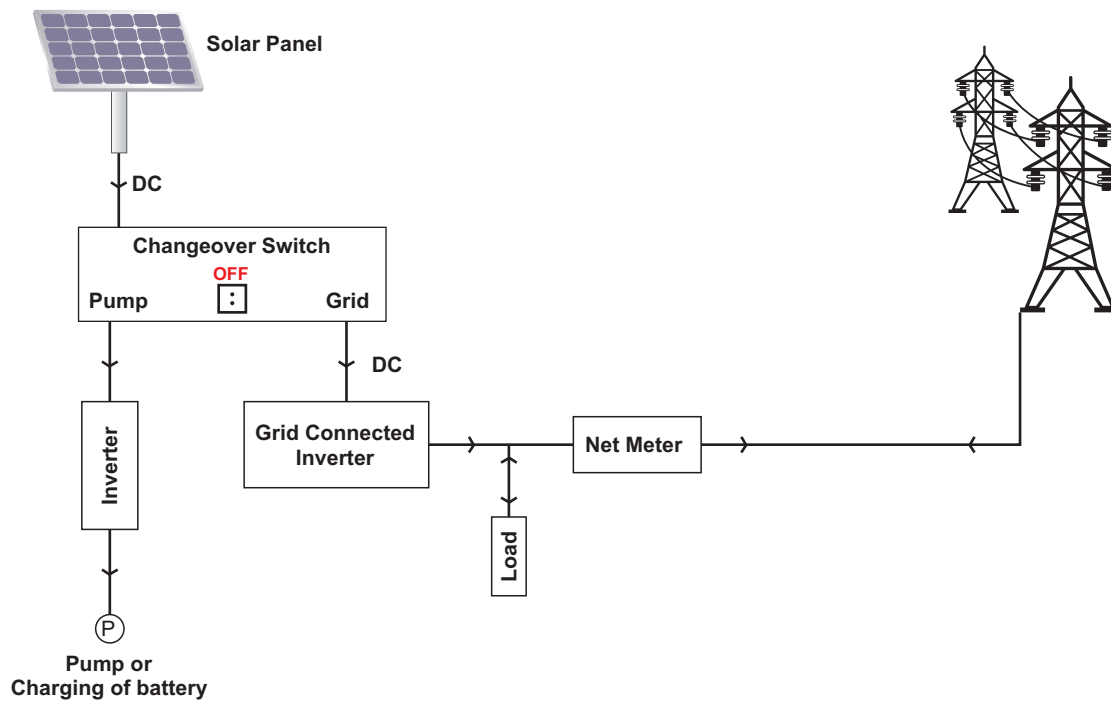

DC Isolators & Changeover

Application - II

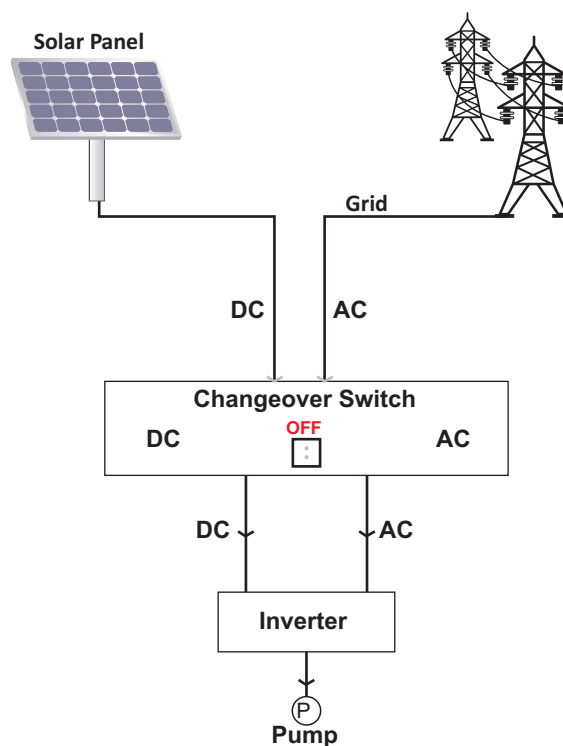

DC Isolators & Changeover (8536)

DC ISOLATORS



AC/DC CHANGEOVER

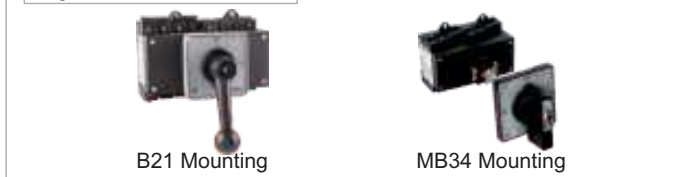

- DC Isolator
- **Range 20A to 63A upto 1500 VDC**
Mounting Options: Standard Front Mounting, DB Mounting, Door interlock & Enclosure Mountings

- **AC/DC Changeover**
- Range 20A to 40A upto 1500 VDC
- Mounting Options: Standard Front Mounting, Door Interlock & Enclosure Mountings available

Description	Cat. No.	AMPS Rating	M.R.P. (₹)
		DC21B (Amps)	Per Unit
4 POLE ISOLATOR		AMPS Rating @ 1000V DC	
Front MTG Switch with Flag Knob	DC LB216 30409 B13 FLGB	20	2488
	DC LB225 30409 B13 FLGB	25	2828
	DC LB232 30409 B13 FLGB	40	3007
Front MTG Switch with Round Knob, Pad Lock	DC LB216 30409 B33 RDGB	20	2668
	DC LB225 30409 B33 RDGB	25	3007
	DC LB232 30409 B33 RDGB	40	3182
DIN Rail MTG Switch with Flag Knob	DC LB216 30409 B23 FLGB	20	2488
	DC LB225 30409 B23 FLGB	25	2828
	DC LB232 30409 B23 FLGB	40	3007
DIN Rail MTG Switch with Flag Knob, DB Mounting	DC LB216 30409 B23P FLBB	16	2577
	DC LB225 30409 B23P FLBB	25	2917
	DC LB232 30409 B23P FLBB	40	3093
	DC LB216 30409 B23DBP FLBB	16	2551
	DC LB225 30409 B23DBP FLBB	25	2886
	DC LB232 30409 B23DBP FLBB	40	3067
Base MTG Switch with DIL and Pad Lock	DC LB216 30409 MB34 RDGB	16	2668
	DC LB225 30409 MB34 RDGB	25	3007
	DC LB232 30409 MB34 RDGB	40	3182
In Plastic Enclosure	DC LB216 30409 SMX RDGB	16	2960
	DC LB225 30409 SMX RDGB	25	3302
	DC LB232 30409 SMX RDGB	40	3478
DIN Rail MTG Switch with Flag Knob, DB Mounting	DC LB363 30409B23DBFLGB	63	6219
DIN Rail MTG Switch with Flag Knob	DC LB363 30409B23FLGB	63	6153
8 POLE ISOLATOR		AMPS Rating @ 1000V DC	
DIN Rail MTG Switch with Ball Grip Handle	DC LB216 30809 B21 BGGB	16	4736
	DC LB225 30809 B21 BGGB	25	5179
	DC LB232 30809 B21 BGGB	40	6257
Base MTG Switch, DIL & Pad Lock with Leech Handle	DC LB216 30809 MB34 LHGB	16	5077
	DC LB225 30809 MB34 LHGB	25	5521
	DC LB232 30809 MB34 LHGB	40	6599
In Plastic Enclosure	DC LB216 30809 B31L SHGB	16	7184
	DC LB225 30809 B31L SHGB	25	7628
	DC LB232 30809 B31L SHGB	40	8705
4 POLE CHANGEOVER		AMPS Rating @ 1000V DC	
DIN Rail MTG Switch with Ball Grip Handle	DC LB216 30154 B21 BGGB	16	4736
	DC LB225 30154 B21 BGGB	25	5179
	DC LB232 30154 B21 BGGB	40	6257
Base MTG Switch, DIL & Pad Lock with Leech Handle	DC LB216 30154 MB34 LHGB	16	5077
	DC LB225 30154 MB34 LHGB	25	5521
	DC LB232 30154 MB34 LHGB	40	6599
In Plastic Enclosure	DC LB216 30154 B31L SHGB	16	7184
	DC LB225 30154 B31L SHGB	25	7628
	DC LB232 30154 B31L SHGB	40	8705

* Note : 2 Pole Isolators can also be supplied on request



FRLS Cable Ducts (8538)

The flammability and smoke performance of rigid PVC (RPVC) plays a significant role in its selection for wiring duct applications. One of the most serious problems of general RPVC cable duct combustion is that it produces large volume of smoke and toxic gases which became the main cause of fire related death. Apart from the irritant effect of HCl gas on the eyes and respiratory system, smoke can cause disorientation and hinder escape from the scene of the fire; which impedes the entry of fire fighters. Hence, the reduction of smoke emissions is clearly desirable.

Salzer FRLS PVC Cable Ducts efficiently carries and protects wires and cables, which are manufactured from specially compounded, low smoke, flame retarded and high impact rigid polyvinyl chloride (RPVC) resin. We modified RPVC wiring duct formulations and used low doses of plasticizer and lubricants to get higher limiting oxygen index (LOI) and low smoke density rating (SDR) with excellent flame retardant (V-0) characteristics. Our wiring duct offers an effective resistance against fire propagation and emits very negligible amount of smokes during fire catching. Salzer cable duct has a flammability rating of V-0, REACH and RoHS compliant and has a continuous use temperature up to 140°F (60 °C). Wide range of colour, sizes and different slotting styles to meet the customer requirements.

Cable Ducts

Type A

A Type

- * Snap fit cover
- * Easy to remove

cover for fast and efficient locking.

Description	1 Meter					2 Meter			
	H x W	Cat. No.(Standard slot Grey)	M.R.P. (₹) Per Unit	Std. Pkg.	Min Order Qty	Cat. No.(Standard slot Grey)	M.R.P. (₹) Per Unit	Std. Pkg.	Min Order Qty
A 15 x 15	WWA1515SG	65	100	100	WWA1515SG2	130	64	64	
A 15 x 25	WWA1525SG	90	100	100	WWA1525SG2	179	64	64	
A 25 x 25	WWA2525SG	108	70	70	WWA2525SG2	216	48	48	
A 30 x 25	WWA3025SG	119	70	70	WWA3025SG2	239	48	48	
A 40 x 30	WWA4030SG	149	75	75	WWA4030SG2	299	32	32	
A 45 x 25	WWA4525SG	151	75	75	WWA4525SG2	304	40	40	
A 45 x 30	WWA4530SG	152	50	50	WWA4530SG2	305	32	32	
A 45 x 45	WWA4545SG	193	50	50	WWA4545SG2	385	18	18	
A 45 x 60	WWA4560SG	233	50	50	WWA4560SG2	466	12	12	
A 60 x 25	WWA6025SG	193	50	50	WWA6025SG2	385	18	18	
A 60 x 45	WWA6045SG	227	50	50	WWA6045SG2	453	18	18	
A 60 x 60	WWA6060SG	269	32	32	WWA6060SG2	538	12	12	
A 60 x 120	WWA60120SG	915	18	90	WWA60120SG2	1829	8	80	
A 75 x 45	WWA7545SG	282	40	40	WWA7545SG2	564	12	12	
A 75 x 75	WWA7575SG	397	32	32	WWA7575SG2	793	12	12	
A 80 x 80	WWA8080SG	444	25	25	WWA8080SG2	888	12	12	
A 100 x 100	WWA100100SG	717	18	18	WWA100100SG2	1434	8	40	

Type B

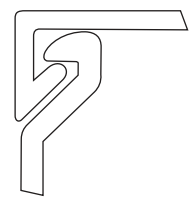



Non slip cover design of minimum encumbrance and maximum grip



- * Non - slip cover
- * Positive locking

Description	1 Meter					2 Meter			
	W x H	Cat. No. (Standard slot)	M.R.P. (₹) Per Unit	Std. Pkg.	Min Order Qty	Cat. No. (Standard slot)	M.R.P. (₹) Per Unit	Std. Pkg.	Min Order Qty
B 25 x 25	WWB2525SG	116	100	100	WWB2525SG2	233	36	36	
B 25 x 30	WWB2530SG	124	100	100	WWB2530SG2	247	36	36	
B 25 x 40	WWB2540SG	151	75	75	WWB2540SG2	303	36	36	
B 25 x 45	WWB2545SG	157	75	225	WWB2545SG2	313	36	108	
B 25 x 60	WWB2560SG	199	50	50	WWB2560SG2	398	18	18	
B 25 x 80	WWB2580SG	270	50	50	WWB2580SG2	540	18	18	
B 25 x 100	WWB25100SG	343	25	25	WWB25100SG2	686	18	18	
B 30 x 20	WWB3020UG	151	100	200	WWB3020UG2	303	36	180	
B 30 x 80	WWB3080SG	374	50	200	WWB3080SG2	748	18	90	
B 40 x 40	WWB4040SG	199	50	50	WWB4040SG2	398	18	18	
B 45 x 45	WWB4545SG	206	50	50	WWB4545SG2	412	18	18	
B 40 x 60	WWB4060SG	241	50	50	WWB4060SG2	482	18	18	
B 40 x 80	WWB4080SG	285	50	50	WWB4080SG2	571	18	18	
B 40 x 100	WWB40100SG	358	25	25	WWB40100SG2	717	12	12	
B 45 x 20	WWB4520UG	158	75	225	WWB4520UG2	315	36	180	
B 50 x 100	WWB50100SG	412	30	90	WWB50100SG2	824	12	60	
B 60 x 20	WWB6020UG	216	50	200	WWB6020UG2	433	18	90	
B 60 x 40	WWB6040SG	241	50	50	WWB6040SG2	482	18	90	
B 60 x 60	WWB6060SG	285	50	50	WWB6060SG2	571	12	12	
B 60 x 80	WWB6080SG	371	40	40	WWB6080SG2	742	12	12	
B 60 x 100	WWB60100SG	488	30	30	WWB60100SG2	976	8	8	
B 72 x 64	WWB7264SG	343	32	96	WWB7264SG2	686	18	90	
B 75 x 75	WWB7575SG	482	32	96	WWB7575SG2	964	8	40	
B 75 x 100	WWB75100SG	504	25	75	WWB75100SG2	1007	8	40	
B 80 x 40	WWB8040SG	291	50	100	WWB8040SG2	583	12	60	
B 80 x 60	WWB8060SG	385	40	80	WWB8060SG2	770	12	60	
B 80 x 80	WWB8080SG	480	32	32	WWB8080SG2	960	12	12	
B 80 x 100	WWB80100SG	539	24	24	WWB80100SG2	1077	8	8	
B 100 x 60	WWB10060SG	459	30	30	WWB10060SG2	919	8	8	
B 100 x 80	WWB10080SG	539	25	25	WWB10080SG2	1077	8	8	
B 100 x 100	WWB100100SG	785	18	18	WWB100100SG2	1570	8	8	
B 120 x 80	WWB12080SG	763	18	90	WWB12080SG2	1526	6	48	
B 150 x 100	WWB150100SG	981	12	48	WWB150100SG2	1961	4	40	
B 150 x 150	WWB150150SG	2131	8	80	WWB150150SG2	4262	2	40	

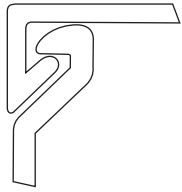
Note : 1) For any special colour request additional 10% will be charged on price. For cut length additional 10% will be charged. 2) Thin / Unslot will be supplied on request. For thin slot replace the cat. number ending with SG by TG, For un-slotted channel replace the cat. number ending with SG by UG. MRP will be same as standard slot.

Type B	Description	1 meter				2 meter			
		W x H	Cat. No. (Thin slot)	M.R.P. (₹) Per Unit	Std. Pkg.	Min Order Qty	Cat. No. (Thin slot)	M.R.P. (₹) Per Unit	Std. Pkg.
 Non slip cover design of minimum encumbrance and maximum grip  B Type * Non - slip cover * Positive locking	B 25 x 30	WWB2530HG	387	100	100	WWB2530HG2	774	36	72
	B 25 x 40	WWB2540HG	493	75	150	WWB2540HG2	986	36	72
	B 25 x 60	WWB2560HG	663	50	100	WWB2560HG2	1326	18	54
	B 25 x 80	WWB2580HG	853	50	100	WWB2580HG2	1706	18	54
	B 25 x 100	WWB25100HG	1047	25	100	WWB25100HG2	2094	18	54
	B 40 x 40	WWB4040HG	581	50	100	WWB4040HG2	1162	18	54
	B 40 x 60	WWB4060HG	772	50	100	WWB4060HG2	1544	18	54
	B 40 x 80	WWB4080HG	936	50	100	WWB4080HG2	1872	18	54
	B 40 x 100	WWB40100HG	1156	25	100	WWB40100HG2	2312	12	48
	B 60 x 40	WWB6040HG	744	50	100	WWB6040HG2	1488	18	54
	B 60 x 60	WWB6060HG	910	50	100	WWB6060HG2	1820	12	48
	B 60 x 80	WWB6080HG	1265	40	120	WWB6080HG2	2530	12	48
	B 60 x 100	WWB60100HG	1460	30	90	WWB60100HG2	2920	8	48
	B 80 x 40	WWB8040HG	910	50	100	WWB8040HG2	1820	12	48
	B 80 x 60	WWB8060HG	1212	40	120	WWB8060HG2	2424	12	48
	B 80 x 80	WWB8080HG	1460	32	96	WWB8080HG2	2920	12	48
	B 80 x 100	WWB80100HG	1596	24	96	WWB80100HG2	3192	8	48
	B 100 x 60	WWB10060HG	1403	30	90	WWB10060HG2	2806	8	48
	B 100 x 80	WWB10080HG	1762	25	100	WWB10080HG2	3524	8	48
	B 100 x 100	WWB100100HG	2118	18	90	WWB100100HG2	4236	8	48

* Under development

Slotting Styles (A & B Types)

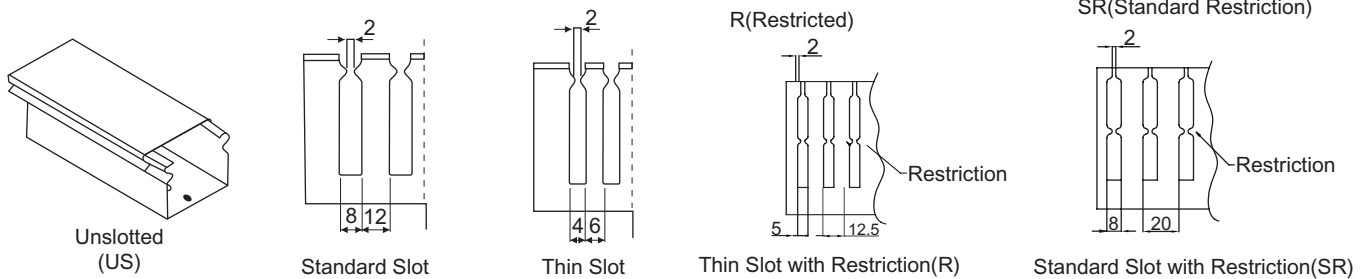

Covers for FRLS Cable Ducts



	Description	Cat. No.	M.R.P. (₹) Per Unit
	Cover for 15 mm A type	CCA15SG	30
	Cover for 25 mm A type	CCA25SG	47
	Cover for 30 mm A type	CCA30SG	57
	Cover for 45 mm A type	CCA45SG	89
	Cover for 60 mm A type	CCA60SG	107
	Cover for 75 mm A type	CCA75SG	135
	Cover for 80 mm A type	CCA80SG	160
	Cover for 100 mm A type	CCA100SG	196
	Cover for 25 mm B type	CCB25SG	49
	Cover for 30 mm B type	CCB30SG	59
	Cover for 40 mm B type	CCB40SG	74
	Cover for 45 mm B type	CCB45SG	91
	Cover for 50 mm B type	CCB50SG	110
	Cover for 60 mm B type	CCB60SG	110
	Cover for 72 mm B type	CCB72SG	139
	Cover for 75 mm B type	CCB75SG	139
	Cover for 80 mm B type	CCB80SG	166
	Cover for 100 mm B type	CCB100SG	202
	Cover for 120 mm B type	CCB120SG	216
	Cover for 150 mm B type	CCB150SG	252

Relays (8536)

- AC & DC relays from 3A to 100 Amps from 1 to 4 pole
- DC power relays upto 125 Amps
- Miniature, General purpose, Power & Automotive Relays
- Termination via Solder, PCB mounted, Plug-In and Screw type terminals
- Silver contacts for enhanced life, **ERDA Tested & complies with JSS standards**

M SERIES - MSP (Equivalent to MY)

MSP	Cat No.	No of Poles	Coil Volts	Min Pack	M.R.P. (₹) Per Unit
 <p>Type MSP (AC/DC) with LED at 240V AC/24V DC Plug in Enclosed Version - 5 Amps Resistive 2 Pole/3 Pole/4 Pole</p>	MSP2P12	2P	12V DC	20	220
	MSP2P24	2P	24V DC	20	220
	MSP2P48	2P	48V DC	20	250
	MSP2P110	2P	110V DC	20	230
	MSP2P12A	2P	12V AC	20	245
	MSP2P24A	2P	24V AC	20	240
	MSP2P110A	2P	110V AC	20	270
	MSP2P240A	2P	240V AC	20	255
	MSP3P12	3P	12V DC	20	230
	MSP3P24	3P	24V DC	20	230
	MSP3P110	3P	110V DC	20	245
	MSP3P24A	3P	24V AC	20	280
	MSP3P110A	3P	110V AC	20	285
	MSP3P240A	3P	240V AC	20	300
	MSP4P12	4P	12V DC	20	230
	MSP4P24	4P	24V DC	20	230
	MSP4P48	4P	48V DC	20	255
	MSP4P110	4P	110V DC	20	250
	MSP4P12A	4P	12V AC	20	295
	MSP4P24A	4P	24V AC	20	285
MSP4P110A	4P	110V AC	20	285	
MSP4P240A	4P	240V AC	20	295	

MSP - Test Button	Cat No.	No of Poles	Coil Volts	Min Pack	M.R.P. (₹) Per Unit
<p>Approvals</p>   <p>2 Pole - 12 Amps/4 Pole - 7 Amps @ 277 V AC/30 V DC with Flag & LED-UL Marked</p>	MSP2P012D12TNE	2P	12V DC	20	270
	MSP2P024D12TNE	2P	24V DC	20	270
	MSP2P110D12TNE	2P	110V DC	20	280
	MSP2P012A12TNE	2P	12V AC	20	290
	MSP2P024A12TNE	2P	24V AC	20	290
	MSP2P110A12TNE	2P	110V AC	20	315
	MSP2P240A12TNE	2P	240V AC	20	305
	MSP4P012D07TNE	4P	12V DC	20	305
	MSP4P024D07TNE	4P	24V DC	20	305
	MSP4P110D07TNE	4P	110V DC	20	325
	MSP4P012A07TNE	4P	12V AC	20	370
	MSP4P024A07TNE	4P	24V AC	20	345
	MSP4P110A07TNE	4P	110V AC	20	365
	MSP4P240A07TNE	4P	240V AC	20	370

M SERIES - MKG

MKG	Cat No.	No of Poles	Coil Volts	Min Pack	M.R.P. (₹) Per Unit
 <p>MKG (AC/DC) with LED indication - 5 Amps Resistive at 240V AC/24 DC Plug in Enclosed Version</p>	MKG2P06	2P	6V DC	10	295
	MKG2P12	2P	12V DC	10	260
	MKG2P18	2P	18V DC	10	310
	MKG2P24	2P	24V DC	10	265
	MKG2P30	2P	30V DC	10	350
	MKG2P48	2P	48V DC	10	285
	MKG2P110	2P	110V DC	10	315
	MKG2P220	2P	220V DC	10	360
	MKG3P12	3P	12V DC	10	330
	MKG3P18	3P	18V DC	10	335
	MKG3P24	3P	24V DC	10	335
	MKG3P30	3P	30V DC	10	410
	MKG3P48	3P	48V DC	10	395
	MKG3P110	3P	110V DC	10	385
	MKG3P220	3P	220V DC	10	515
	MKG2P06A	2P	06V AC	10	290
	MKG2P12A	2P	12V AC	10	270
	MKG2P24A	2P	24V AC	10	265
	MKG2P110A	2P	110V AC	10	265
	MKG2P240A	2P	240V AC	10	340
MKG3P12A	3P	12V AC	10	325	
MKG3P24A	3P	24V AC	10	315	
MKG3P110A	3P	110V AC	10	325	
MKG3P240A	3P	240V AC	10	390	



RELAYS

M SERIES - MKP

MKP	Cat No.	No of Poles	Coil Volts	Min Pack	M.R.P. (₹) Per Unit
 <p>Type MKP (AC/DC) with LED indication -10 Amps Resistive at 240V AC/24V DC Plug in Enclosed Version</p>	MKP2P06	2P	06V DC	10	300
	MKP2P12	2P	12V DC	10	295
	MKP2P24	2P	24V DC	10	300
	MKP2P48	2P	48V DC	10	330
	MKP2P110	2P	110V DC	10	330
	MKP2P220	2P	220V DC	10	445
	MKP3P12	3P	12V DC	10	365
	MKP3P24	3P	24V DC	10	365
	MKP3P48	3P	48V DC	10	410
	MKP3P110	3P	110V DC	10	430
	MKP3P220	3P	220V DC	10	590
	MKP2P06A	2P	06V AC	10	320
	MKP2P12A	2P	12V AC	10	315
	MKP2P24A	2P	24V AC	10	315
	MKP2P110A	2P	110V AC	10	325
	MKP2P240A	2P	240V AC	10	420
	MKP3P12A	3P	12V AC	10	415
	MKP3P24A	3P	24V AC	10	415
	MKP3P110A	3P	110V AC	10	405
	MKP3P240A	3P	240V AC	10	465

Relays (8536)

M SERIES - MKP

MKP	Cat No.	No of Poles	Coil Volts	Min Pack	M.R.P. (₹) Per Unit
<p>Approvals</p>   <p>Type MKP (AC/DC) with LED indication -10 Amps Resistive at 277V AC/24 DC Plug in Enclosed Version with Test Button/Mechanical Indicator</p>	MKP2P012D10TNE	2P	12V DC	10	380
	MKP2P024D10TNE	2P	24V DC	10	380
	MKP2P110D10TNE	2P	110V DC	10	415
	MKP3P012D10TNE	3P	12V DC	10	455
	MKP3P024D10TNE	3P	24V DC	10	455
	MKP3P110D10TNE	3P	110V DC	10	515
	MKP2P024A10TNE	2P	24V AC	10	400
	MKP2P110A10TNE	2P	110V AC	10	410
	MKP2P240A10TNE	2P	240V AC	10	510
	MKP3P024A10TNE	3P	24V AC	10	500
	MKP3P110A10TNE	3P	110V AC	10	495
	MKP3P240A10TNE	3P	240V AC	10	555

Sockets for MK / MSP Series (8538)

SOCKETS	Cat No.	Coil Volts	Min. Pack	M.R.P. (₹) Per Unit
	MK08C	8 Pin for 2 C/O & Closed Terminals for "MKG/MKP" Relays	20	72
	MK11C	11 Pin for 3 C/O & Closed Terminals for "MKG/MKP" Relays	20	105
	MSP08C	Closed Terminals Socket for MSP - 2 Pole	20	107
	MSP14C	Closed Terminals Socket for MSP - 4 Pole	20	140
	MSP14P	PCB Socket for MSP - 4 Pole	50	52

UL Sockets for MK / MSP Series available on request

M SERIES - MIC

MIC	Cat No.	No of Poles	Coil Volts	Min Pack	M.R.P. (₹) Per Unit
 <p>MIC (AC/DC) - 12 Amps Resistive at 240V AC/24V DC/ Enclosed solder/ PCB Version</p>	MIC2P12	2P	12V DC	20	240
	MIC2P24	2P	24V DC	20	250
	MIC3P12	3P	12V DC	20	280
	MIC3P24	3P	24V DC	20	285

M SERIES - MSC

MSC	Cat No.	No of Poles	Coil Volts	Min Pack	M.R.P. (₹) Per Unit
 <p>MSC (AC/DC) - 5 Amps Resistive at 240V AC/24V DC Enclosed Solder Version</p>	MSC1P12	1P	12V DC	10	150
	MSC1P18	1P	18V DC	10	160
	MSC1P24	1P	24V DC	10	155
	MSC2P06	2P	06V DC	10	230
	MSC2P12	2P	12V DC	10	210
	MSC2P18	2P	18V DC	10	225
	MSC2P24	2P	24V DC	10	220
	MSC2P48	2P	48V DC	10	265
	MSC3P06	3P	06V DC	10	295
	MSC3P12	3P	12V DC	10	260
	MSC3P18	3P	18V DC	10	270
	MSC3P24	3P	24V DC	10	260
	MSC3P48	3P	48V DC	10	355
	MSC3P110	3P	110V DC	10	335
	MSC2P240A	2P	240V AC	10	330
MSC3P240A	3P	240V AC	10	365	

H SERIES - HSC

HSC	Cat No.	No of Poles	Coil Volts	Min Pack	M.R.P. (₹) Per Unit
 <p>HSC (AC/DC) - 10 Amps Resistive at 240V AC/24V DC Enclosed Solder Version</p>	HSC1P12	1P	12V DC	10	210
	HSC1P18	1P	18V DC	10	235
	HSC1P24	1P	24V DC	10	220
	HSC2P12	2P	12V DC	10	285
	HSC2P18	2P	18V DC	10	340
	HSC2P24	2P	24V DC	10	300
	HSC3P12	3P	12V DC	10	360
	HSC3P24	3P	24V DC	10	375
	HSC2P240A	2P	240V AC	10	455
	HSC3P240A	3P	240V AC	10	515

H SERIES - HSR

HSR	Cat No.	No of Poles	Coil Volts	Min Pack	M.R.P. (₹) Per Unit
 <p>HSR (AC/DC) - 16 Amps Resistive at 240V AC/24V DC/ Enclosed Solder Version</p>	HSR1P12	1P	12V DC	10	225
	HSR1P18	1P	18V DC	10	245
	HSR1P24	1P	24V DC	10	250
	HSR2P12	2P	12V DC	10	320
	HSR2P18	2P	18V DC	10	355
	HSR2P24	2P	24V DC	10	330
	HSR3P12	3P	12V DC	10	410
	HSR3P18	3P	18V DC	10	480
	HSR3P24	3P	24V DC	10	440
	HSR2P240A	2P	240V AC	10	570
HSR3P240A	3P	240V AC	10	605	

Relays

PRC SERIES - Power Relays

PRC	Cat No.	No of Poles	Coil Volts	Min Pack	M.R.P. (₹) Per Unit
 <p>PRC 30 (AC/DC) - 30 Amps Resistive at 240V AC/24V DC/ Enclosed</p>	PRC301P12	1P	12V DC	4	375
	PRC301P24	1P	24V DC	4	380
	PRC302P12	2P	12V DC	4	505
	PRC302P24	2P	24V DC	4	510
	PRC303P12	3P	12V DC	4	670
	PRC303P24	3P	24V DC	4	675
	PRC301P240A	1P	240V AC	4	410
	PRC302P240A	2P	240V AC	4	540
	PRC303P240A	3P	240V AC	4	690

 <p>PRC 40 (AC/DC) - 40 Amps Resistive at 240V AC/24V DC/ Enclosed</p>	PRC401P12	1P	12V DC	4	380
	PRC401P24	1P	24V DC	4	385
	PRC401P48	1P	48V DC	4	530
	PRC401P240A	1P	240V AC	4	415

 <p>PRC 60 (AC/DC) - 60 Amps Resistive at 240V AC/24V DC/ Enclosed</p> <p>PRC 80 (AC/DC)-80 Amps Resistive at 240V AC/24V DC/ Enclosed</p> <p>PRC 100 (AC/DC) - 100 Amps Resistive at 240V AC/24V DC/ Enclosed</p>	PRC601P12	1P	12V DC	4	430
	PRC601P24	1P	24V DC	4	440
	PRC601P240A	1P	240V AC	4	525
	PRC801P12	1P	12V DC	3	535
	PRC801P24	1P	24V DC	3	550
	PRC801P240A	1P	240V AC	3	720
	PRC1001P12	1P	12V DC	3	735
	PRC1001P24	1P	24V DC	3	770
	PRC1001P240A	1P	240V AC	3	790

1 & 2 Changeovers with 2,4,6 & 8 channels

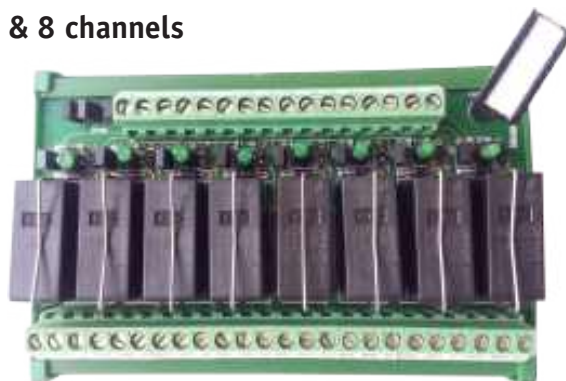

1 C/O RELAY MODULE

	Description	Modules	Cat No.	MRP (₹) Per Unit
	1 CO, 24VDC with OMRON Relay	2	RMS021P24	470
	1 CO, 24VDC with OMRON Relay	4	RMS041P24	860
	1 CO, 24VDC with OMRON Relay	8	RMS081P24	1385

1 C/O RELAY MODULE

	Description	Modules	Cat No.	MRP (₹) Per Unit
	1 CO, 110VAC with OMRON Relay	4	RMS041P110AC	1665
	1 CO, 110VAC with OMRON Relay	8	RMS081P110AC	2985
	1 CO, 230VAC with OMRON Relay	2	RMS021P230AC	960
	1 CO, 230VAC with OMRON Relay	4	RMS041P230AC	1855
	1 CO, 230VAC with OMRON Relay	8	RMS081P230AC	3625

2 C/O RELAY MODULE

	Description	Modules	Cat No.	MRP (₹) Per Unit
	2 CO, 24VDC with OMRON Relay	2	RMS022P24	620
	2 CO, 24VDC with OMRON Relay	4	RMS042P24	1075
	2 CO, 24VDC with OMRON Relay	8	RMS082P24	2070

2 C/O RELAY MODULE

	Description	Modules	Cat No.	MRP (₹) Per Unit
	2 CO, 230VAC with OMRON Relay	2	RMS022P230AC	1095
	2 CO, 230VAC with OMRON Relay	4	RMS042P230AC	2035
	2 CO, 230VAC with OMRON Relay	8	RMS082P230AC	4060

* Other Coil Voltages offered on request

PATENTED DESIGN



**Single Phase -
Automatic Changeover
with Current Limiter**

ACCL

ACCL is Used for Efficient Distribution of Single Phase Generator Power in Residential Apartments, Commercial Complex, Townships etc without Overloading the Generator. The ACCL will Switch the Load to Generator Supply During Mains Failure. It also Acts as a Current Limiter when Load on Generator Exceeds the Pre-Set Limit the ACCL goes into an Overload Trip Cycle mode Alerting users through LED Indication / Beep to Reduce Any Excess Load Connected to the Circuit .

RATING	DESCRIPTION	CODE	MRP (₹) Per Unit
0.5	ACCL with DG Trip at 0.5A / Mains 30A	RACCL005S	2761
1	ACCL with DG Trip at 1A / Mains 30A	RACCL010S	2761
1.5	ACCL with DG Trip at 1.5A / Mains 30A	RACCL015S	2761
2.5	ACCL with DG Trip at 2.5A / Mains 30A	RACCL025S	2761
3	ACCL with DG Trip at 3A / Mains 30A	RACCL030S	2761
4	ACCL with DG Trip at 4A / Mains 30A	RACCL040S	2761
5	ACCL with DG Trip at 5A / Mains 30A	RACCL050S	2761
6	ACCL with DG Trip at 6A / Mains 30A	RACCL060S	2761
8	ACCL with DG Trip at 8A / Mains 30A	RACCL080S	2761
9	ACCL with DG Trip at 9A / Mains 30A	RACCL090S	2761
10	ACCL with DG Trip at 10A / Mains 30A	RACCL100S	2761
15	ACCL with DG Trip at 15A / Mains 30A	RACCL150S	2761
20	ACCL with DG Trip at 20A / Mains 30A	RACCL200S	2761
25	ACCL with DG Trip at 25A / Mains 30A	RACCL250S	2761
30	ACCL with DG Trip at 30A / Mains 30A	RACCL300S	2867

Terminal Connectors (8538)

- **Range from 2.5-95 Sq.mm Universal mounting**
Standard terminal connectors, Miniature, Double Level, Triple Level connectors & Screwless connectors
- **UL94 V0 grade material**
Fuse terminals, Earth Terminals, Stud Test & Disconnecting Terminals & Distribution Terminal Blocks
- **Accessories** : End plate / Clamp, Marking ferrules, Group markers, shorting links & Din rails

Standard Feed through Screw Clamp Terminals

	Cat No.	Suitable for Wire Size (mm ²)	Std Pack Nos	M.R.P. (₹) Per Unit
	SCRW2.5U	2.5	100	9.40
	SCRW2.5UE	4	100	11.20
	SCRW4U	4	100	11.50
	SCRW6U	6	100	15.50
	SCRW10U	10	100	19.50
	SCRW16U	16	50	37.00
	SCRW25U	25	50	58.30
	SCRW35U	35	50	83.40
	SCRW50U	50	20	245.00
	SCRW95U	95	10	354.00

Double Level Terminals

	Cat No.	Suitable for Wire Size (mm ²)	Std Pack Nos	M.R.P. (₹) Per Unit
	DBL4U	4	100	30.80
	DBLOFF4U	4	100	36.00
	DBL4U(I.S.)	4	100	41.00
	Accessories			
	EPDBL 4U	DBL4U / DBL4U(I.S.)	100	12.00
	SPDBL 4U - Spacer	DBL4U / DBL4U(I.S.)	100	12.00
	EPDBLOFF 4U	DBLOFF4U / 4UA - FRONT SIDE	100	17.00
	EPDBLOFF4UA	DBLOFF4U / 4UA - BACK SIDE	100	8.00



Triple Level Terminals

	Cat No.	Suitable for Wire Size (mm ²)	Std Pack Nos	M.R.P. (₹) Per Unit
	TL2.5U	2.5	100	80.00
	TL2.5UH	2.5	100	45.00
	Accessories			
	EPTL2.5U	TL2.5U/UL	100	18.00
	EPTL2.5UH	TL2.5UH	100	18.00

Multiple Connection Terminals

	Cat No.	Suitable for Wire Size (mm ²)	Std Pack Nos	M.R.P. (₹) Per Unit
	SCRW 4U 1-2	4	100	29.00
	SCRW 4U 2-2	4	100	40.00
	Accessories			
	EPSCRW4U 1-2	SCRW 4U 1-2	100	12.00
	EPSCRW4U 2-2	SCRW 4U 2-2	100	17.00

Micro Terminals

	Cat No.	Suitable for Wire Size (mm ²)	Std Pack Nos	M.R.P. (₹) Per Unit
	M4	4	100	10.40
	Accessories			
	EPM4	M4	100	8.00
	PPM4	M4	100	9.00
Panel Mount Terminal 	Cat No.	Suitable for Wire Size (mm²)	Std Pack Nos	M.R.P. (₹) Per Unit
	P4	4	100	13.00
	EPP4	P4	100	6.00

Fuse & Disconnect Terminals

	Cat No.	Suitable for Wire Size (mm ²)	Std Pack Nos	M.R.P. (₹) Per Unit	
	F4U	4	100	41.50	
	F4U(L)	4	100	64.00	
	F6U	6	50	80.00	
	FDBL4U	4	50	104.00	
	FDBL4UE	4	50	119.00	
	Accessories				
	EPF4U	F4U/F4U(L) / DISCTL4U	100	10.00	
	PPF4U	F4U/F4U(L) / DISCTL4U	100	14.00	
	EPFDBL4U	FDBL4U/4UE	100	17.00	

Disconnect & Test Terminals

	Cat No.	Suitable for Wire Size (mm ²)	Std Pack Nos	M.R.P. (₹) Per Unit	
	KN4U	4	50	54.00	
	DISCT6U	6	50	70.50	
	DISCT6US	6	25	193.00	
	Accessories				
	EPKN4U	KN4U	100	11.00	
	EPDISCT6U	DISCT6U / US	100	16.00	

Stud Disconnect & Test Terminals for Current Transformer

	Cat No.	Suitable for Wire Size (mm ²)	Std Pack Nos	M.R.P. (₹) Per Unit	
	STUDDISCT6U	6	25	69.00	
	STUDDISCT6US	6	25	182.00	
	Accessories				
	EPSTUDDISCT6U	STUDDISCT6U / STUDDISCT6US	100	16.00	

Spring Clamp Terminals

	Cat No.	Suitable for Wire Size (mm ²)	Std Pack Nos	M.R.P. (₹) Per Unit
	CAGE2.5	2.5	100	12.80
	CAGE4	4	450	21.80
	CAGE6	6	50	42.50
	CAGE2.5 1-2	2.5	100	23.00
	CAGE4 1-2	4	50	36.00
	CAGE6 1-2	6	50	69.00
	CAGE2.5 2-2	2.5	100	30.00
	CAGE4 2-2	4	50	46.00
	CAGE6 2-2	6	50	55.00
	CAGEP2.5	2.5	100	12.00
	CAGEP2.5 2-2	2.5	100	22.00
	CAGEG2.5	2.5	100	68.00
	CAGEG4	4	50	81.00
	CAGEG6	6	50	105.00

Terminal Connectors

Stud Type Terminals

	Cat No.	Suitable for Wire Size (mm ²)	Std Pack Nos	M.R.P. (₹) Per Unit
	STUD B4	10	100	37.00
	STUD B5	16	100	46.00
	STUD N4	10	100	39.00
	STUD N5	16	100	48.00
	STUD B6	35	100	74.00
	STUD N6	35	100	66.00
	Accessories For Stud Type Terminals			
EPSTUD	STUD B4,B5., B6,N4,N5,N6		100	11.00
PPSTUD	STUD B4,B5., B6,N4,N5,N6		100	18.00

Grounding Terminals

	Cat No.	Suitable for Wire Size (mm ²)	Std Pack Nos	M.R.P. (₹) Per Unit
	G4	4	50	75.00
	GM4	4	100	47.00
	G6	6	50	87.00
	G10	10	20	99.00
	G16	16	50	125.00
	G35	35	20	248.00

Neutral / earth screw clamp busbar system

	Cat No.	Suitable for Wire Size (mm ²)	Std Pack Nos	M.R.P. (₹) Per Unit
	GN4	6	100	13.00
	GN16	16	50	17.00
	GN35	35	50	28.00
	NB10-3 (1 MTR)	COPPER BUS BAR (10x3)	5	655.00
	NB6-6 (1 MTR)	COPPER BUS BAR (6x6)	5	655.00
	NBS	NBS	50	15.00

Distribution Blocks

	Cat No.	Input (Sq.mm)	No. of Outputs	Std Pack Nos	M.R.P. (₹) Per Unit
	DISBL4/1	16	4	10	161.00
	DISBL4/2	16	8	10	194.00
	DISBL4/3	16	12	10	222.00
	DISBL4/4	16	16	10	290.00
	DISBL4/5	16	20	10	301.00
	DISBL4/2(1)	16	4	10	174.00
	DISBL4/3(1)	16	6	10	190.00
	DISBL4/4(1)	16	8	10	204.00
	DISBL4/5(1)	16	10	10	227.00
	DISBL4/6(1)	16	12	10	245.00
	DISBL4/10(1)	16	20	10	318.00
	DISBL4/11(1)	16	22	10	339.00
	DISBL6/2	25	8	10	207.00
	DISBL6/3	25	12	10	263.00
	DISBL6/4	25	16	10	280.00
	DISBL10/2	35	8	10	247.00
	DISBL10/3	35	12	10	301.00
DISBL10/4	35	16	10	356.00	

Accessories - End Plates (8538)

	Cat No.	Suitable for Wire Size (mm ²)	Std Pack Nos	M.R.P. (₹) Per Unit
	EPSCRW2.5U/4U	SCRW2.5U/4U	100	7.00
	EPSCRW6U/10U	SCRW6U/10U	100	7.00
	EPSCRW25U	SCRW25U	100	10.00
	EPSCRW35U	SCRW35U	100	12.00
	EPCAGE2.5	CAGE2.5	100	9.00
	EPCAGE4	CAGE4	100	11.00
	EPCAGE6	CAGE6	100	16.00
	EPCAGE2.5 1-2	CAGE2.5 1-2	100	10.00
	EPCAGE4 1-2	CAGE4 1-2	100	12.00
	EPCAGE6 1-2	CAGE6 1-2	100	20.00
	EPCAGE2.5 2-2	CAGE2.5 2-2	100	12.00
	EPCAGE4 2-2	CAGE4 2-2	100	17.00
	EPCAGEP2.5	CAGEP2.5 (set of Left & Right)	100	11.00

Partition Plates

	Cat No.	Suitable for Wire Size (mm ²)	Std Pack Nos	M.R.P. (₹) Per Unit
	PPSCRW2.5U/4U	SCRW2.5U/4U	100	12.00
	PPSCRW6U/10U	SCRW6U/10U	100	16.00
	PPSCRW25U	SCRW25U	100	17.00
	PPSCRW35U	SCRW35U	100	20.00
	PPCAGE2.5	CAGE2.5	100	11.00
	PPCAGE4	CAGE4	100	14.00
	PPCAGE6	CAGE6	100	18.00
	PPCAGE2.5 1-2	CAGE2.5 1-2	100	14.00
	PPCAGE2.5 2-2	CAGE2.5 2-2	100	17.00
	PPCAGE4 1-2	CAGE4 1-2	100	17.00
	PPCAGE4 2-2	CAGE4 2-2	100	21.00
	PPCAGE6 1-2	CAGE6 1-2	100	21.00
	PPCAGE6 2-2	CAGE6 2-2	100	34.00

Separator Plate

	Cat No.	Suitable for Wire Size (mm ²)	Std Pack Nos	M.R.P. (₹) Per Unit
	SPSCRW2.5U/4U	SCRW2.5/4U	100	6.00
	SPSCRW6U/10U	SCRW6/10U	100	6.00
	SPSCRW16U	SCRW16U / SCRW16UCR	100	6.00
	SPDBL4U	DBL4U	100	6.00
	SPP4	P4	100	6.00

Group Marker Holders

	Cat No.	Suitable for Wire Size (mm ²)	Std Pack Nos	M.R.P. (₹) Per Unit
	GRPM1	ES1N	100	11.00
	GRPM2	ES3N	100	11.00
	GRPM3	ES2N	100	11.00
	GRPM4	ES3N	100	11.00
	GRPM5	ES2N	100	11.00
	GRPM6	ALL MOUNTING RAILS	100	22.00
	GRPM7	ALL MOUNTING RAILS	100	29.00

Terminal Connectors

Accessories

Marking Labels

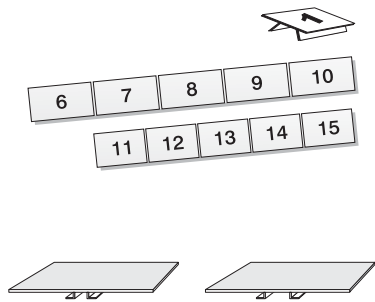

	Cat No.	Suitable for Wire Size (mm ²)	Std Pack Nos	M.R.P. (₹) Per Unit
	KM/2	DBL4U/4U(I.S) / P4 / F4U / FDBL4U / TL2.5U/UL/UH/UHL / M4/4S/4SU / DISCTL4U/DBLDISCTL4U/ GM4 / DBL4U(E) SERIES	100	3.00
	KM/3	CAGEP2.5 2-2	100	3.00
	KM/4	CAGEP2.5	100	3.00
	KM/5	SCRW2.5U / GN4 / TH2.5U K/J/T / CAGE2.5/2.5 1-2/2-2	100	3.00
	KM/6	SCRW4U/4U1-2/4U2-2 / DBL4U / DBLOFF4U/4UA / G4 / KN4U / GN16/35 / CAGE4/4 1-2/2-2 / DISBL4/1-5 / 4/2(1)-44(1)	100	3.00
	KM/8	SCRW6U / F4U / DISBL6/2-4 / FDBL4U / 4U(E)/4ULR/4U(E)LR / DISCT6U/L6U / CAGE6/6 1-2	100	3.00
	KM/10	SCRW10U / G10 / DISBL10/2-4	100	3.00
	KM/12	SCRW16U/25U	100	3.00
	KM/15	SCRW35U / G35	100	3.00
	KM/50	SCRW50U	100	3.00
	KM/95	SCRW95U	100	3.00
	KM/G1,G2	ES1N OR M4/DBL4U/SCRW50U/95U	100	3.00

TERMINAL CONNECTORS

End Clamp / End Stopper



	Cat No.	Suitable for Wire Size (mm ²)	Std Pack Nos	M.R.P. (₹) Per Unit
	ES1S	DIN 35 RAIL	100	13.00
	ES2S	DIN 35-15 RAIL	100	13.00
	ES3S	DIN 32 RAIL	100	10.00
	ES1N	DIN 15 RAIL	100	8.00
	ES2N	DIN 35 / DIN 35-15 / DIN 32 RAIL	100	12.00
	ES3N	DIN 35 RAIL / DIN 35-15 RAIL	100	9.90
	MTGBKT18	STEEL	100	22.00
	SPACER8			10.00
	MTGBASE18	DIN 35/35-15	100	19.00

Din Rails / Channels



	Cat No.	Std Pack Nos	M.R.P. (₹) Per Unit
	DIN15/5.5MM - 1M (suitable for M4 Terminal)	100	106.00
	DIN35/7.5MM - 1M (suitable for All Terminals)	50	142.00
	DIN35/7.5MM - 1M - S (suitable for All Terminals)	50	149.00
	DIN35/15MM - 1M (suitable for All Terminals)	50	227.00
	DIN35/15MM - 1M - S (suitable for All Terminals)	50	250.00

Note: For Shorting links and other accessories please contact Factory

Prices given here for **Grey Color**, for other colors 10% extra will be charged
(Other Color possible are Red / Yellow / Blue / Black / Green / White / Brown
with MOQ of 200 Nos per color)

- **Limit switches** : Available in Normal / Snap action
- Precision limit switches: 1NO + 1NC / 2NO +2NC
- Operating force: From Light to Heavy duty applications
- Versatile mounting heads, Rugged aluminum die cast housing



SL200 Series

Cat No.	Description	Contact Details		MRP (₹) Per Unit
		Action	Contact	
SL201	Ball Actuator	Snap Action	1NO+1NC	850
SL202	Roller Actuator	Snap Action	1NO+1NC	955
SL203	Roller Lever Actuator	Snap Action	1NO+1NC	955
SL207/1	Angular Roller Lever Actuator RS	Snap Action	1NO+1NC	955

Note: SL 207/1 - Angular Roller Lever Actuator Right Side

SL 600Series



Cat No.	Description	Contact Details		MRP (₹) Per Unit
		Action	Contact	
SL600	Only Push Rod Operated without Housing (without protection cover)	Snap Action	1NO+1NC	285
SL600 P	Only Push Rod Operated without Housing (with protection cover)	Snap Action	1NO+1NC	330
SL600PBP	Push Rod Operated without Housing (with protection cover) - Bulk Pack	Snap Action	1NO+1NC	330
SL600N	Push Rod Operated Without Housing	Normal Action	1NO+1NC	240
SL600NP	Push Rod Operated Without Housing (with protection cover)	Normal Action	1NO+1NC	275
SL600NPBP	Push Rod Operated Without Housing (with protection Cover) - Bulk Pack	Normal Action	1NO+1NC	275
SL600PDL	Push Rod Operated without Housing (with protection cover)	Snap Action	1NO+1NC	275
SL600NPDL	Push Rod Operated without Housing (with protection cover)	Normal Action	1NO+1NC	270
SL600NPDLBP	Push Rod Operated Without Housing (with protection cover) - Bulk Pack	Normal Action	1NO+1NC	270
SL603	Aluminum Housing with Normal Roller Lever Actuator with IP65	Snap Action	1NO+1NC	795
SL605	Aluminum Housing with 38mm Rotating Roller Lever Assembly	Snap Action	1NO+1NC	1495
SL609	Aluminum Housing with Short Lever Roller Actuator with IP43	Snap Action	1NO+1NC	790

Limit Switches (8536)

LIMIT SWITCHES

SL 700 Series



SL709



SL705

Cat No.	Description	Contact Details		MRP (₹) Per Unit
		Snap Action	1NO+1NC	
SL702	Top Push Roller Spring Return	Snap Action	1NO+1NC	1495
SL705	38mm Long, Rotating Roller Lever Spring Return	Snap Action	1NO+1NC	1620
SL7061	Nylon Catwhisker Spring Return	Snap Action	1NO+1NC	1410
SL708	76mm long Rotating Roller Lever Spring Return	Snap Action	1NO+1NC	1620
SL709	Rotating Adjustable Roller Lever (32mm-82.5mm) Spring Return	Snap Action	1NO+1NC	1620

SL 1500 Series



SL1500-1A



SL1503-1AR

Cat No.	Description	Contact Details		MRP (₹) Per Unit
		Snap Action	1NO+1NC	
SL5001A	Only Contact Block Without Operator	Snap Action	1NO+1NC	560
SL5022AH	Top Push Roller Operator Horizontal IP 65 from the Top	Snap Action	2NO+2NC	965
SL15031AR	Roller Lever Operator Right Hand Mounting	Snap Action	1NO+1NC	730
SL15032AR		Snap Action	2NO+2NC	940

Note: 1A - 1NO+1NC : 2AH - 2NO+2NC Horizontal operations
 1AR - 1NO+1NC, Right Hand Mounting
 2AR - 2NO+2NC, Right Hand Mounting

- 16 Amps - 125 Amps with IP44 & IP67
- 200 Amps - 400 Amps with IP67
- Combination Socket Box & Mobile Combination Socket
- SCHUKO Plug & Sockets
- Socket with switch & Mechanical Interlock
- 20V- 50V Low voltage plug & socket

Protection Type	Rating AMP	No of Poles	230V 50 & 60 Hz	400V 50 & 60 Hz	MRP (₹) Per Unit
			Part Number	Part Number	

	Connectors					
	IP 44	16	2+E	IP01634-510		627
	IP 44	16	3+E		IP01644-514	731
	IP 44	16	3+N+E		IP01654-5	740
	IP 44	32	2+E	IP03234-522		900
	IP 44	32	3+E		IP03244-526	1053
	IP 44	32	3+N+E		IP03254-6	1124
	IP 44	63	2+E	IP06334-1237		4257
	IP 44	63	3+E		IP06344-1241	4559
IP 44	63	3+N+E		IP06354-1245	4815	

	Plugs					
	IP 44	16	2+E	IP01634-248		436
	IP 44	16	3+E		IP01644-252	564
	IP 44	16	3+N+E		IP01654-3	579
	IP 44	32	2+E	IP03234-260		695
	IP 44	32	3+E		IP03244-264	809
	IP 44	32	3+N+E		IP03254-4	904
	IP 44	63	2+E	IP06334-1227		2936
	IP 44	63	3+E		IP06344-1231	3853
IP 44	63	3+N+E		IP06354-1235	4078	

	Panel Mounted Socket, Straight					
	IP 44	16	2+E	IP01634-1366		531
	IP 44	16	3+E		IP01644-1390	771
	IP 44	16	3+N+E		IP01654-1385	778
	IP 44	32	2+E	IP03234-1395		853
	IP 44	32	3+E		IP03244-1399	984
	IP 44	32	3+N+E		IP03254-3451	1026
	IP 44	63	2+E	IP06334-1261		3145
	IP 44	63	3+E		IP06344-1248	3500
IP 44	63	3+N+E		IP06354-1252	4045	

	Panel Mounted Socket, Angled					
	IP 44	16	2+E	IP01634-1463		531
	IP 44	16	3+E		IP01644-1467	771
	IP 44	16	3+N+E		IP01654-1473	778
	IP 44	32	2+E	IP03234-1492		853
	IP 44	32	3+E		IP03244-1496	984
	IP 44	32	3+N+E		IP03254-1500	1026
	IP 44	63	2+E	IP06334-1147		3145
	IP 44	63	3+E		IP06344-1151	3500
IP 44	63	3+N+E		IP06354-1155	4045	

	Wall Mounted Socket					
	IP 44	16	2+E	IP01634-101		1035
	IP 44	16	3+E		IP01644-105	1279
	IP 44	16	3+N+E		IP01654-111	1440
	IP 44	32	2+E	IP03234-1421		1799
	IP 44	32	3+E		IP03244-1425	1947
	IP 44	32	3+N+E		IP03254-1557	2130
	IP 44	63	2+E	IP06334-1137		4193
	IP 44	63	3+E		IP06344-1141	4554
IP 44	63	3+N+E		IP06354-1145	5096	

PLUG & SOCKET

Plug & Socket (8536)

PLUG & SOCKET

Protection Type	Rating AMP	No of Poles	230V 50 & 60 Hz	400V 50 & 60 Hz	MRP (₹) Per Unit
			Part Number	Part Number	



Panel Mounted Inlets					
IP 44	16	2+E	IP01634-812		605
IP 44	16	3+E		IP01644-813	692
IP 44	16	3+N+E		IP01654-815	771
IP 44	32	2+E	IP03234-817		862
IP 44	32	3+E		IP03244-819	979
IP 44	32	3+N+E		IP03254-821	1132
IP 44	63	2+E	IP06334-1981		2910
IP 44	63	3+E		IP06344-1982	3417
IP 44	63	3+N+E		IP06354-1688	3924



Wall Mounted Inlets					
IP 44	16	2+E	IP01634-332		1152
IP 44	16	3+E		IP01644-336	1420
IP 44	16	3+N+E		IP01654-342	1600
IP 44	32	2+E	IP03234-344		2001
IP 44	32	3+E		IP03244-348	2169
IP 44	32	3+N+E		IP03254-354	2364
IP 44	63	2+E	IP06334-606		4660
IP 44	63	3+E		IP06344-3607	5057
IP 44	63	3+N+E		IP06354-3608	5664



Wall Mounted Socket, Switched with Interlock					
IP 44	16	2+E	IP01634-7002		5779
IP 44	16	3+E		IP01644-5100	7705
IP 44	16	3+N+E		IP01654-5103	8989
IP 44	32	2+E	IP03234-5696		9310
IP 44	32	3+E		IP03244-5105	9631
IP 44	32	3+N+E		IP03254-5108	10594
IP 44	63	2+E	IP06334-6571		14462
IP 44	63	3+E		IP06344-5956	15002
IP 44	63	3+N+E		IP06354-5959	19260



Wall Mounted Socket, Switched with Interlock					
IP 44	16	2+E	IP01634-7274		4855
IP 44	16	3+E		IP01644-7275	5137
IP 44	16	3+N+E		IP01654-7276	6100

Protection Type	Rating AMP	No of Poles	230V 50 & 60 Hz	400V 50 & 60 Hz	MRP (₹) Per Unit
			Part Number	Part Number	

Connectors

IP 67	16	2+E	IP01636-540		1413
IP 67	16	3+E		IP01646-544	1655
IP 67	16	3+N+E		IP01656-550	1655
IP 67	32	2+E	IP03236-552		1927
IP 67	32	3+E		IP03246-556	2040
IP 67	32	3+N+E		IP03256-562	2040
IP 67	63	2+E	IP06336-1574		4623
IP 67	63	3+E		IP06346-1117	5006
IP 67	63	3+N+E		IP06356-1121	5554
IP 67	125	2+E	IP12536-3390		12840
IP 67	125	3+E		IP12546-1450	13161
IP 67	125	3+N+E		IP12556-1454	14445

Plugs

IP 67	16	2+E	IP01636-278		547
IP 67	16	3+E		IP01646-282	1285
IP 67	16	3+N+E		IP01656-288	1316
IP 67	32	2+E	IP03236-290		1542
IP 67	32	3+E		IP03246-294	1606
IP 67	32	3+N+E		IP03256-300	1606
IP 67	63	2+E	IP06336-1571		4062
IP 67	63	3+E		IP06346-1110	4573
IP 67	63	3+N+E		IP06356-1114	4815
IP 67	125	2+E	IP12536-3400		9631
IP 67	125	3+E		IP12546-1443	12520
IP 67	125	3+N+E		IP12556-1447	12840

Panel mounted socket, straight

IP 67	16	2+E	IP01636-218		1124
IP 67	16	3+E		IP01646-222	1221
IP 67	16	3+N+E		IP01656-228	1285
IP 67	32	2+E	IP03236-230		1413
IP 67	32	3+E		IP03246-234	1574
IP 67	32	3+N+E		IP03256-240	1574
IP 67	63	2+E	IP06336-1264		3853
IP 67	63	3+E		IP06346-1124	4458
IP 67	63	3+N+E		IP06356-1128	4495
IP 67	125	2+E	IP12536-3380		9631
IP 67	125	3+E		IP12546-1457	14124
IP 67	125	3+N+E		IP12556-1461	14445

Panel mounted socket, angled

IP 67	16	2+E	IP01636-1475		1124
IP 67	16	3+E		IP06356-1479	1221
IP 67	16	3+N+E		IP01656-1485	1285
IP 67	32	2+E	IP03236-1502		1413
IP 67	32	3+E		IP03246-1506	1574
IP 67	32	3+N+E		IP03256-1551	1574
IP 67	63	2+E	IP06336-2180		3853
IP 67	63	3+E		IP06346-205	4458
IP 67	63	3+N+E		IP06356-209	4495
IP 67	125	2+E	IP12536-3575		9631
IP 67	125	3+E		IP12546-212	14124
IP 67	125	3+N+E		IP12556-216	14445

Plug & Socket (8536)

	Protection Type	Rating AMP	No of Poles	230V 50 & 60 Hz	400V 50 & 60 Hz	MRP (₹) Per Unit
				Part Number	Part Number	
	Wall Mounted Socket					
	IP 67	16	2+E	IP01636-1192		1591
	IP 67	16	3+E		IP01646-1196	1830
	IP 67	16	3+N+E		IP01656-1200	1863
	IP 67	32	2+E	IP03236-1202		2055
	IP 67	32	3+E		IP03246-1206	2247
	IP 67	32	3+N+E		IP03256-1210	2247
	IP 67	63	2+E	IP06336-128		4590
	IP 67	63	3+E		IP06346-132	4944
	IP 67	63	3+N+E		IP06356-136	5766
	IP 67	125	2+E	IP12536-1381		12680
	IP 67	125	3+E		IP12546-139	14124
IP 67	125	3+N+E		IP12556-143	15730	
	Panel Mounted Inlets					
	IP 67	16	2+E	IP01636-826		771
	IP 67	16	3+E		IP01646-827	885
	IP 67	16	3+N+E		IP01656-829	985
	IP 67	32	2+E	IP03236-831		1124
	IP 67	32	3+E		IP03246-832	1252
	IP 67	32	3+N+E		IP03256-834	1445
	IP 67	63	2+E	IP06336-836		3196
	IP 67	63	3+E		IP06346-3656	3710
	IP 67	63	3+N+E		IP06356-3658	4223
	IP 67	125	2+E	IP12536-3665		6967
	IP 67	125	3+E		IP12546-3583	8315
IP 67	125	3+N+E		IP12556-1983	9647	
	Wall Mounted Inlets					
	IP 67	16	2+E	IP01636-1003		1574
	IP 67	16	3+E		IP01646-1004	1687
	IP 67	16	3+N+E		IP01656-1005	1927
	IP 67	32	2+E	IP03236-1006		2280
	IP 67	32	3+E		IP03246-1007	2440
	IP 67	32	3+N+E		IP03256-1008	2682
	IP 67	63	2+E	IP06336-1107		5105
	IP 67	63	3+E		IP06346-357	5507
	IP 67	63	3+N+E		IP06356-361	6420
	Wall Mounted Socket, Switched with Interloc					
	IP 67	16	2+E	IP01636-7012		8346
	IP 67	16	3+E		IP01646-5600	8667
	IP 67	16	3+N+E		IP01656-5603	10915
	IP 67	32	2+E	IP03236-5793		10915
	IP 67	32	3+E		IP03246-5605	11878
	IP 67	32	3+N+E		IP03256-5608	14124
	IP 67	63	2+E	IP06336-5911		16049
	IP 67	63	3+E		IP06346-5110	18458
	IP 67	63	3+N+E		IP06356-5113	24074

PLUG & SOCKET

		Protection Type	Rating AMP	No of Poles	230V 50 & 60 Hz	400V 50 & 60 Hz	MRP (₹) Per Unit
					Part Number	Part Number	
	Wall Mounted Socket, Switched with Interlock	IP 67	16	2+E	IP01636-7278		7384
		IP 67	16	3+E		IP01646-7279	7705
		IP 67	16	3+N+E		IP01656-7280	9310
	Schuko Plug	IP 54	16	2+E	IP01635-10838		386
	Schuko Connector	IP 54	16	2+E	IP01635-10843		503
	Schuko Panel Mounted Socket	IP 54	16	2+E	IP01635-11031		418

Standard Contactors (8536)

- **Range :**9A to 105 Amps Reversing, Non Reversing 4 Frames (F1-9 to 25A, F2-32&40A, F3-50 to 80A, F4-95&105A)
- Accessories: Front & Side Mounted Auxiliary Contact, Wiring Modules Interlocks, Surge Suppressors
- Confirms to UL 60947-4-1A
- Confirms to IEC 60947-5-1



AC3	AC1	NO	NC	Type / Description	Cat No	MRP (₹) Per Unit
9	25		NC	9A AC 3Pole (1 N.C. Aux)	SC009P3001AxxxFL	1030
9	25	NO		9A AC 3Pole (1 N.O. Aux)	SC009P3010AxxxFL	1030
12	25		NC	12A AC 3Pole (1 N.C. Aux)	SC012P3001AxxxFL	1135
12	25	NO		12A AC 3Pole (1 N.O. Aux)	SC012P3010AxxxFL	1135
18	32		NC	18A AC 3Pole (1 N.C. Aux)	SC018P3001AxxxFL	1280
18	32	NO		18A AC 3Pole (1 N.O. Aux)	SC018P3010AxxxFL	1280
25	32		NC	25A AC 3Pole (1 N.C. Aux)	SC025P3001AxxxFL	1560
25	32	NO		25A AC 3Pole (1 N.O. Aux)	SC025P3010AxxxFL	1560
32	60			32A AC 3Pole	SC032P3000AxxxFL	3565
32	60		NC	32A AC 3Pole (1 N.C. Aux)	SC032P3001AxxxFL	3845
32	60	NO		32A AC 3Pole (1 N.O. Aux)	SC032P3010AxxxFL	3845
40	60			40A AC 3Pole	SC040P3000AxxxFL	5120
40	60		NC	40A AC 3Pole (1 N.C. Aux)	SC040P3001AxxxFL	5405
40	60	NO		40A AC 3Pole (1 N.O. Aux)	SC040P3010AxxxFL	5405
40	60	NO	NC	40A AC 3Pole (1NO+ 1NC)	SC040P3011AxxxFL	5650
50	90	NO	NC	50A AC 3Pole (1NO+ 1NC)	SC050P3011AxxxFL	7495
65	110	NO	NC	65A AC 3Pole (1NO+ 1NC)	SC065P3011AxxxFL	10745
80	110	NO	NC	80A AC 3Pole (1NO+ 1NC)	SC080P3011AxxxFL	12855
95	140	NO	NC	95A AC 3Pole (1NO+ 1NC)	SC095P3011AxxxFL	16795
105	140	NO	NC	105A AC 3Pole (1NO+ 1NC)	SC105P3011AxxxFL	20585

Note: xxx - Voltage to be substituted

Volts	24	48	110	230WB	240	380	415	440
Code xxx	24	48	110	230	240	380	415	440

* 230WB (175 to 255V)

Standard Contactors 9A - 105A AC Non Reversing with DC Coil



AC3	AC1	NO	NC	Type / Description	Cat No	MRP (₹) Per Unit
9	25		NC	9A AC 3Pole (1 N.C. Aux)	SC009P3001DxxxL	1900
9	25	NO		9A AC 3Pole (1 N.O. Aux)	SC009P3010DxxxL	1900
12	25		NC	12A AC 3Pole (1 N.C. Aux)	SC012P3001DxxxL	2145
12	25	NO		12A AC 3Pole (1 N.O. Aux)	SC012P3010DxxxL	2145
18	32		NC	18A AC 3Pole (1 N.C. Aux)	SC018P3001DxxxL	2410
18	32	NO		18A AC 3Pole (1 N.O. Aux)	SC018P3010DxxxL	2410
25	32		NC	25A AC 3Pole (1 N.C. Aux)	SC025P3001DxxxL	3230
25	32	NO		25A AC 3Pole (1 N.O. Aux)	SC025P3010DxxxL	3230
32	60			32A AC 3Pole	SC032P3000DxxxL	6280
40	60			40A AC 3Pole	SC040P3000DxxxL	7045
50	90	NO	NC	50A AC 3Pole (1NO+ 1NC)	SC050P3011DxxxL	8485
65	110	NO	NC	65A AC 3Pole (1NO+ 1NC)	SC065P3011DxxxL	11245
80	110	NO	NC	80A AC 3Pole (1NO+ 1NC)	SC080P3011DxxxL	13865
95	140	NO	NC	95A AC 3Pole (1NO+ 1NC)	SC095P3011DxxxL	18960
105	140	NO	NC	105A AC 3Pole (1NO+ 1NC)	SC105P3011DxxxL	22660

Note: xxx - Voltage to be substituted

Volts	24	48	110	220
Code xxx	24	48	110	220

MC Range Mini Contactors

- Range : 7A to 16 Amps, Control relays-16 Amps
- Accessories: Auxiliary Contact, PCB Link Module, Electronic Timer,
- Mechanical / Electrical Interlocks, Wiring Module, Surge Suppressor etc.
- Confirms to UL 60947-4-1A
- Confirms to IEC 60947-5-1



AC3	AC1	NO	NC	Type / Description	Cat No	MRP (₹) Per Unit
7	18		NC	7A AC 3Pole (1 N.C. Aux)	MC007P3001AxxxFL	1045
7	18	NO		7A AC 3Pole (1 N.O. Aux)	MC007P3010AxxxFL	1045
9	20		NC	9A AC 3Pole (1 N.C. Aux)	MC009P3001AxxxFL	1095
9	20	NO		9A AC 3Pole (1 N.O. Aux)	MC009P3010AxxxFL	1095
12	22		NC	12A AC 3Pole (1 N.C. Aux)	MC012P3001AxxxFL	1140
12	22	NO		12A AC 3Pole (1 N.O. Aux)	MC012P3010AxxxFL	1140
16	22		NC	16A AC 3Pole (1 N.C. Aux)	MC016P3001AxxxFL	1180
16	22	NO		16A AC 3Pole (1 N.O. Aux)	MC016P3010AxxxFL	1180

Note: xxx - Voltage to be substituted

Volts	24	110	240	415
Code xxx	24	110	240	415

MC Range Mini Contactors 7A-16A AC 3Pole Non Reversing with DC Coil

AC3	AC1	NO	NC	Type / Description	Cat No	MRP (₹) Per Unit
7	18		NC	7A AC 3Pole (1 N.C. Aux)	MC007P3001DxxxL	1540
7	18	NO		7A AC 3Pole (1 N.O. Aux)	MC007P3010DxxxL	1540
9	20		NC	9A AC 3Pole (1 N.C. Aux)	MC009P3001DxxxL	1620
9	20	NO		9A AC 3Pole (1 N.O. Aux)	MC009P3010DxxxL	1620
12	22		NC	12A AC 3Pole (1 N.C. Aux)	MC012P3001DxxxL	1680
12	22	NO		12A AC 3Pole (1 N.O. Aux)	MC012P3010DxxxL	1680
16	22		NC	16A AC 3Pole (1 N.C. Aux)	MC016P3001DxxxL	1745
16	22	NO		16A AC 3Pole (1 N.O. Aux)	MC016P3010DxxxL	1745

Note: xxx - Voltage to be substituted

Volts	24	42	48	110	220
Code xxx	24	42	48	110	220

CR Range Control Relay 16A AC 4Pole with AC Coil, 50Hz (AC15 5A at 415V)



AC1	Type / Description	Cat No	MRP (₹) Per Unit
16	16A, 2NO 2NC	CR016P0022AxxxFL	1220
16	16A, 3NO 1NC	CR016P0031AxxxFL	1220
16	16A, 1NO 3NC	CR016P0013AxxxFL	1220
16	16A, 4NO	CR016P0040AxxxFL	1220
16	16A, 4NC	CR016P0004AxxxFL	1220

Note: xxx - Voltage to be substituted

Volts	24	110	240	415
Code xxx	24	110	240	415

CR Range Control Relay 16A AC 4Pole with DC Coil (AC15 5A at 415V)

AC1	Type / Description	Cat No	MRP (₹) Per Unit
16	16A, 2NO 2NC	CR016P0022DxxxL	1620
16	16A, 3NO 1NC	CR016P0031DxxxL	1620
16	16A, 1NO 3NC	CR016P0013DxxxL	1620
16	16A, 4NO	CR016P0040DxxxL	1620
16	16A, 4NC	CR016P0004DxxxL	1620

Note: xxx - Voltage to be substituted

Volts	24	48	110	220
Code xxx	24	48	110	220

Accessories for Standard Contactor (8538)

Auxiliary Contacts Front Mounted

Auxiliary Contacts Side Mounted



Description	Cat No	MRP (₹) Per Unit
1NO	SCFA10L	175
1NC	SCFA01L	175
1NO (Early Make)	SCFA10EML	385
1NC (Delayed Break)	SCFA01DBL	385

Description	Cat No	MRP (₹) Per Unit
1NO	SCSA10L	280
1NC	SCSA01L	280
1NO + 1NC	SCSA11L	530
2NO	SCSA20L	530

Interlocks - SC009 ~ SC105



Description	Cat No	MRP (₹) Per Unit
Mechanical Interlock	SCSMIL	515
Mechanical & Electrical Interlock	SCSMEIL	545

Reversing Wiring Module Kit



Description	Cat No	MRP (₹) Per Unit
Sc009 ~ SC025 Contactors	SC025RWM1L (Load Side)	485
	SC025RWM2L (Line Side)	485
Sc032 ~ SC040 Contactors	SC040RWM1L (Load Side)	625
	SC040RWM2L (Line Side)	625

Surge Supressors



Description	Cat No	MRP (₹) Per Unit
RC 24 ~ 48V AC - SC009 ~ SC040	SC040SSRA048L	470
RC 50 ~ 127V AC - SC009 ~ SC040	SC040SSRA127L	470
RC 130 ~ 250V AC - SC009 ~ SC040	SC040SSRA250L	470
RC 24 ~ 48V AC - SC050 ~ SC105	SC105SSRA048L	470
RC 50 ~ 127V AC - SC050 ~ SC105	SC105SSRA127L	470
RC 130 ~ 250V AC - SC050 ~ SC105	SC105SSRA250L	470
Diode 12 ~ 600V DC - SC009 ~ SC105	SC105SSDD600L	140

Spare Wound Coils



Spare Wound Coils AC 9A - 25A

Description	Cat No	MRP (₹) Per Unit
12V 50Hz	SC025A012FL	570
24V 50Hz	SC025A024FL	570
42V 50Hz	SC025A042FL	570
48V 50Hz	SC025A048FL	570
110V 50Hz	SC025A110FL	570
220V 50Hz	SC025A220FL	570
230-240V 50Hz	SC025A240FL	570
360V 50Hz	SC025A360FL	570
380V 50Hz	SC025A380FL	570
400-415V 50Hz	SC025A415FL	570
440V 50Hz	SC025A440FL	570
525 50Hz	SC025A525FL	570

Spare Wound Coils AC 32A - 40A

Description	Cat No	MRP (₹) Per Unit
12V 50Hz	SC040A012FL	595
24V 50Hz	SC040A024FL	595
42V 50Hz	SC040-A042FL	595
48V 50Hz	SC040A048FL	595
110V 50Hz	SC040A110FL	595
220V 50Hz	SC040A220FL	595
230-240V 50Hz	SC040A240FL	595
360 50Hz	SC040A360FL	595
380V 50Hz	SC040A380FL	595
400-415V 50Hz	SC040A415FL	595
440V 50Hz	SC040A440FL	595

Spare Wound Coils DC 9A - 25A

Description	Cat No	MRP (₹) Per Unit
12V DC	SC025D012L	1285
24V DC	SC025D024L	1285
48V DC	SC025D048L	1285
110V DC	SC025D110L	1285
220V DC	SC025D220L	1285

Spare Wound Coils DC 32A - 40A

Description	Cat No	MRP (₹) Per Unit
12V DC	SC040D012L	1340
24V DC	SC040D024L	1340
48V DC	SC040D048L	1340
110V DC	SC040D110L	1340

Spare Wound Coils DC 50A - 105A

Description	Cat No	MRP (₹) Per Unit
24-28V DC	SC050D024L	3495
48V DC	SC050D048L	3495
110V DC	SC050D110L	3495
24V DC	SC065D024L	3495
48V DC	SC065D048L	3495
110V DC	SC065D110L	3495
24V DC	SC080D024L	5885
48V DC	SC080D048L	5885
110V DC	SC080D110L	5885
24V DC	SC105D024L	5885
48V DC	SC105D048L	5885
110V DC	SC105D110L	5885



Spare Wound Coils AC 50A - 65A

Description	Cat No	MRP (₹) Per Unit
12V 50Hz	SC065A012FL	1880
24V 50Hz	SC065A024FL	1880
42V 50Hz	SC065A042FL	1880
48V 50Hz	SC065A048FL	1880
110V 50Hz	SC065A110FL	1880
230V 50Hz	SC065A230FL	1880
230-240V 50Hz	SC065A240FL	1880
360 50Hz	SC065A360FL	1880
380V 50Hz	SC065A380FL	1880
400-415V 50Hz	SC065A415FL	1880
440V 50Hz	SC065A440FL	1880

Spare Wound Coils AC 80A - 105A

Description	Cat No	MRP (₹) Per Unit
12V 50Hz	SC105A012FL	3195
24V 50Hz	SC105A024FL	3195
42V 50Hz	SC105A042FL	3195
48V 50Hz	SC105A048FL	3195
110V 50Hz	SC105A110FL	3195
230V 50Hz	SC105A230FL	3195
230-240V 50Hz	SC105A240FL	3195
360 50Hz	SC105A360FL	3195
380V 50Hz	SC105A380FL	3195
400-415V 50Hz	SC105A415FL	3195
440V 50Hz	SC105A440FL	3195

Accessories for Mini Contactors & Control Relays (8538)

Auxiliary Contacts Front Mounted Mini Contactor



Description	Cat No	MRP (₹) Per Unit
2 NO	MCFA20L	295
1 NO + 1 NC	MCFA11L	295
2 NC	MCFA02L	295
4 NO	MCFA40L	480
2 NO + 2 NC	MCFA22L	480
4 NC	MCFA04L	480
3 NO + 1 NC	MCFA31L	480
1 NO + 3 NC	MCFA13L	480

Auxiliary Contacts Front Mounted Control Relay

Description	Cat No	MRP (₹) Per Unit
2 NO	CRFA20L	295
1 NO + 1 NC	CRFA11L	295
2 NC	CRFA02L	295
4 NO	CRFA40L	480
2 NO + 2 NC	CRFA22L	480
4 NC	CRFA04L	480
3 NO + 1 NC	CRFA31L	480
1 NO + 3 NC	CRFA13L	480

Reversing Wiring Module



Description	Cat No	MRP (₹) Per Unit
Reversing Power Wiring Module	MCRWM16M1L (Load Side)	245
	MCRWM16M2L (Line Side)	245

Mechanical Interlock



Description	Cat No	MRP (₹) Per Unit
Front Mounted Mechanical Interlock	MCFMMIL	275

Surge Suppressor RC Type



Description	Cat No	MRP (₹) Per Unit
12-24V AC 50/60Hz	MCSSRA024BL	455
24-48V AC 50/60Hz	MCSSRA048BL	455
48-127V AC 50/60Hz	MCSSRA127BL	455
127-250V AC 50/60Hz	MCSSRA250BL	455
250-380V AC 50/60Hz	MCSSRA380BL	455
380-510V AC 50/60Hz	MCSSRA510BL	455

Surge Suppressor Varistor Type

Description	Cat No	MRP (₹) Per Unit
12-48V AC/12-60V DC	MCSSVD048L	445
50-127V AC/60-180V DC	MCSSVD127L	445
130-275V AC/ 80-300V DC	MCSSVD275L	445
277-380V AC/300-510V DC	MCSSVA380L	445
400-510V AC	MCSSVA510L	445

Diode Type

Description	Cat No	MRP (₹) Per Unit
12 - 600V DC	MCSSDD600L	140

Spare Wound Coils AC



Description	Cat No	MRP (₹) Per Unit
24V 50/60Hz	MC016A024BL	340
48V 50/60Hz	MC016A048BL	340
110V 50Hz / 120V 60 Hz	MC016A110FL	340
230V 50/60Hz	MC016A230BL	340
400V 50/60Hz	MC016A400BL	340

Spare Wound Coils DC

Description	Cat No	MRP (₹) Per Unit
DC 12V	MC016D012L	560
DC 24V	MC016D024L	560
DC 110V	MC016D110L	560
DC 125V	MC016D125L	560
DC 250V	MC016D250L	560

Bimetallic Over Load Relay 5 Frames from 0.28-112 Amps

Bimetal Thermal Overload Relays Mini Contactor
BR1 frame - MC007 ~ MC016

Bimetal Thermal Overload Relays,
Class 10 BR2, BR3, BR4 & BR5 frame -
SC009 ~ SC105



Current Range	Cat No	MRP (₹) Per Unit
0.28 ~ 0.4A	BR1L40L	1440
0.4 ~ 0.63A	BR1L63L	1440
0.56 ~ 0.8A	BR1L80L	1440
0.8 ~ 1.2A	BR1M12L	1440
1.2 ~ 1.8A	BR1M18L	1440
1.8 ~ 2.8A	BR1M28L	1440
2.8 ~ 4.A	BR1M40L	1455
4 ~ 6.3A	BR1M63L	1455
5.6 ~ 8A	BR1M80L	1455
7 ~ 10A	BR1H10L	1455
8 ~ 12.5A	BR1H12L	1480
10 ~ 15A	BR1H15L	1480
11 ~ 17A	BR1H17L	1480

Current Range	Cat No	MRP (₹) Per Unit
0.28 ~ 0.4A	BR2L40L	1440
0.4 ~ 0.63A	BR2L63L	1440
0.56 ~ 0.8A	BR2L80L	1440
0.8 ~ 1.2A	BR2M12L	1440
1.2 ~ 1.8A	BR2M18L	1440
1.8 ~ 2.8A	BR2M28L	1440
2.8 ~ 4.A	BR2M40L	1455
4 ~ 6.3A	BR2M63L	1455
5.6 ~ 8A	BR2M80L	1455
7 ~ 10A	BR2H10L	1455
8 ~ 12.5A	BR2H12L	1480
10 ~ 15A	BR2H15L	1480
11 ~ 17A	BR2H17L	1480
15 ~ 23A	BR2H23L	1580
22 ~ 32A	BR2H32L	2330
25 ~ 40A	BR3H40L	2330
32 ~ 50A	BR4H50L	3305
40 ~ 57A	BR4H57L	3830
50 ~ 63A	BR4H63L	4100
57 ~ 70A	BR4H70L	4370
63 ~ 80A	BR5H80L	4845
78 ~ 97A	BR5H97L	5015
90 ~ 112A	BR5X11L	5315

Accessories (8538)

Mounting Adapters - Bimetallic Overload Relays



Description	Cat No	MRP (₹) Per Unit
Separate Mounting Adapter for B2 Overload Relays	BRSMA2L	320
Separate Mounting Adapter for B3 & B4 Overload Relays	BRSMA4L	730
Separate Mounting Adapter for B5 Overload Relays	BRSMA5L	1010

Motor Protection Circuit Breaker (MPCB)

- Available in 2 frame sizes 32 & 63 Amps
- CE listed & certified as per the standard EN 60947-4-1 & EN 60947-2
- UL Listed as per UL 60947-4-1 for all applications
- Has complete range of common accessories for both 32A & 63A frames including Rotary operating handle, Enclosure, Trip indicating contact etc.

B23 Mounting (with Overload & Short Circuit protection ie Thermal & Magnetic trip)

Relay Range	Description	Cat No	MRP (₹) Per Unit
0.1-0.16 A	32A with Thermal & Magnetic Trip 0.1 ~ 0.16 A	MP132TS2L16B23	3520
0.16-0.25 A	32A with Thermal and Magnetic Trip 0.16 ~ 0.25 A	MP132TS2L25B23	3520
0.25-0.4 A	32A with Thermal and Magnetic Trip 0.25 ~ 0.4 A	MP132TS2L40B23	3520
0.4-0.63 A	32A with Thermal and Magnetic Trip 0.4 ~ 0.63 A	MP132TS2L63B23	3520
0.63-1.0 A	32A with Thermal and Magnetic Trip 0.63 ~ 1 A	MP132TS2M10B23	3520
1.0-1.6 A	32A with Thermal and Magnetic Trip 1.0 ~ 1.6 A	MP132TS2M16B23	4035
1.6-2.5 A	32A with Thermal and Magnetic Trip 1.6 ~ 2.5 A	MP132TS2M25B23	4035
2.5-4.0A	32A with Thermal and Magnetic Trip 2.5 ~ 4 A	MP132TS2M40B23	4035
4.0-6.3 A	32A with Thermal and Magnetic Trip 4.0 ~ 6.3 A	MP132TS2M63B23	4035
6.3-10 A	32A with Thermal and Magnetic Trip 6.3 ~ 10 A	MP132TS2H10B23	4035
10-16 A	32A with Thermal and Magnetic Trip 10 ~ 16 A	MP132TS2H16B23	4225
16-20 A	32A with Thermal and Magnetic Trip 16 ~ 20 A	MP132TS2H20B23	4545
20-25 A	32A with Thermal and Magnetic Trip 20 ~ 25 A	MP132TS2H25B23	4545
25-32 A	32A with Thermal and Magnetic Trip 25 ~ 32 A	MP132TS2H32B23	6275



MPCB with B23 Mounting (with Only Short Circuit protection ie Magnetic trip)

Relay Range	Description	Cat No	MRP (₹) Per Unit
0.1-0.16 A	32A with Magnetic Trip 0.16 A	MP132MS2L16B23	3460
0.16-0.25 A	32A with Magnetic Trip 0.25 A	MP132MS2L25B23	3460
0.25-0.4 A	32A with Magnetic Trip 0.4 A	MP132MS2L40B23	3460
0.4-0.63 A	32A with Magnetic Trip 0.63 A	MP132MS2L63B23	3460
0.63-1.0 A	32A with Magnetic Trip 1 A	MP132MS2M10B23	3460
1.0-1.6 A	32A with Magnetic Trip 1.6 A	MP132MS2M16B23	3970
1.6-2.5 A	32A with Magnetic Trip 2.5 A	MP132MS2M25B23	3970
2.5-4.0A	32A with Magnetic Trip 4 A	MP132MS2M40B23	3970
4.0-6.3 A	32A with Magnetic Trip 6.3 A	MP132MS2M63B23	3970
6.3-10 A	32A with Magnetic Trip 10 A	MP132MS2H10B23	3970
10-16 A	32A with Magnetic Trip 16 A	MP132MS2H16B23	4160
16-20 A	32A with Magnetic Trip 20 A	MP132MS2H20B23	4480
20-25 A	32A with Magnetic Trip 25 A	MP132MS2H25B23	4480
25-32 A	32A with Magnetic Trip 32 A	MP132MS2H32B23	6210

Motor Protection Circuit Breaker (MPCB)

MPCB

63A-B23 Mounting (with Overload & Short Circuit protection - (Thermal & Magnetic trip)

Relay Range	Description	Cat No	MRP (₹) Per Unit
11-16 A	63A with Thermal & Magnetic Trip 11-16 A	MP263TS4H16B23	9040
14-20 A	63A with Thermal & Magnetic Trip 14-20 A	MP263TS4H20B23	9040
18.25 A	63A with Thermal & Magnetic Trip 18.25 A	MP263TS4H25B23	9040
22-32 A	63A with Thermal & Magnetic Trip 22-32 A	MP263TS4H32B23	9040
28-40 A	63A with Thermal & Magnetic Trip 28-40 A	MP263TS4H40B23	15635
36-45 A	63A with Thermal & Magnetic Trip 36-45 A	MP263TS4H45B23	15635
40-50 A	63A with Thermal & Magnetic Trip 40-50 A	MP263TS4H50B23	16590
45-63 A	63A with Thermal & Magnetic Trip 45-63 A	MP263TS4H16B23	16590

63A-B23 Mounting (with Overload & Short Circuit protection - Magnetic trip)

Relay Range	Description	Cat No	MRP (₹) Per Unit
11-16 A	63A with Magnetic Trip 11-16 A	MP263MS4H16B23	8980
14-20 A	63A with Magnetic Trip 14-20 A	MP263MS4H20B23	8980
18.25 A	63A with Magnetic Trip 18.25 A	MP263MS4H25B23	8980
22-32 A	63A with Magnetic Trip 22-32 A	MP263MS4H32B23	15575
28-40 A	63A with Magnetic Trip 28-40 A	MP263MS4H40B23	15575
36-45 A	63A with Magnetic Trip 36-45 A	MP263MS4H45B23	15575
40-50 A	63A with Magnetic Trip 40-50 A	MP263MS4H50B23	16530
45-63 A	63A with Magnetic Trip 45-63 A	MP263MS4H16B23	16530

MB34 Mounting - Available for Price Contact Head Office



Accessories



Description	Cat No	MRP (₹) Per Unit
Front Mounted Auxiliary 1 NO + 1 NC	MPAF11	385



Left Side Mounted Auxiliary 1NO+1 NC	MPAS11	545
Left Side Mounted Auxiliary 2NO	MPAS20	545
Left Side Mounted Auxiliary 2NC	MPAS02	545



Trip Indication Auxillary (Left mounted) (1NO+1NC for overload signal & 1NO+1NC for short circuit signal)	MPAST11	1270
---	---------	------

Accessories



Operating handle for MP 132 , FPYR	MP132HND09MB34FPYR	735
------------------------------------	--------------------	-----



Enclosure Small with padlock knob (For purpose of mounting only MPCB without accessories) (YR-Yellow Red, GB - Grey Black)	MP132B31SM1YR	1920
--	---------------	------



Enclosure Big with padlock knob (For purpose of mounting MPCB with accessories) (YR-Yellow Red, GB - Grey Black)	MP132B31SM2YR	2180
--	---------------	------



UV trip (Right Mounted)	MPURXXXF	1280
-------------------------	----------	------



Shunt Trip (Right Mounted)	MPSRXXXB	1280
----------------------------	----------	------

Description	Code
MP Shunt Release 100 ~ 127V 50/60Hz	127
MP Shunt Release 20 ~ 24V 50/60Hz	024
MP Shunt Release 200 ~ 240V 50/60Hz	240
MP Shunt Release 40 ~ 48V 50/60Hz	048
MP Shunt Release 365 - 440V 50/60Hz	440
MP UV Release 95V 50Hz / 110V 60Hz	095
MP UV Release 110-115V 50Hz / 127V 60Hz	115
MP UV Release 190V 50Hz / 220V 60 Hz	190
MP UV Release 325V 50Hz / 380V 60Hz	325
MP UV Release 20V 50Hz / 24V 60Hz	020
MP UV Release 110V 50Hz / 120V 60Hz	110
MP UV Release 208V 50 Hz / 240V 60 Hz	208
MP UV Release 24V 50Hz / 28V 60Hz	024
MP UV Release 180V 50Hz / 208V 60Hz	180
MP UV Release 230-240V 50Hz / 277V 60Hz	240
MP UV Release 380V 50Hz / 440V 60Hz	380
MP UV Release 400-415V 50Hz / 480V 60Hz	415
MP UV Release 500V 50Hz / 600V 60Hz	500
MP UV Release 24V 50/60Hz	024

- MCB's are offered in various current ratings from 0.5A to 63 Amps
- In Single pole, Single pole with Neutral, Double & Triple pole, Triple pole with Neutral & Four pole, with **10KA Short Circuit rating in B, C & D Curve** .
- **Isolators** offered from 32A to 63Amps in Double pole, Triple pole & Four pole

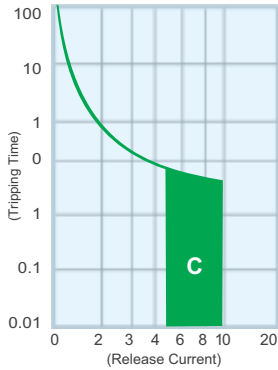

Miniature Circuit Breakers are intended to provide protection against overloads and short circuits, which can cause damage to cables & equipment. MCB's are offered in various current ratings & configurations as below. When current in a circuit exceeds the rating of the MCB the Thermal Bi-Metallic element gets heated & initiates the tripping action. Higher the overload faster the MCB trips.

Magnetic element initiates a rapid tripping action in less than 1/10th of a second on sensing higher fault currents. Typically C type MCB's trips above 5 to 10 times the rated current and are mainly used where loads are Inductive & Resistive. MCB's can withstand & clear fault currents upto 10KA.

Single Pole MCB



Rating	Description	STD.Pack	Cat No	MRP (₹) Per Unit
1	1A Single Pole MCB - C	1/12/144	MXSPC001	390
2	2A Single Pole MCB - C	1/12/144	MXSPC002	390
3	3A Single Pole MCB - C	1/12/144	MXSPC003	390
4	4A Single Pole MCB - C	1/12/144	MXSPC004	390
6	6A Single Pole MCB - C	1/12/144	MXSPC006	240
10	10A Single Pole MCB - C	1/12/144	MXSPC100	240
16	16A Single Pole MCB - C	1/12/144	MXSPC160	240
20	20A Single Pole MCB - C	1/12/144	MXSPC200	240
25	25A Single Pole MCB - C	1/12/144	MXSPC250	240
32	32A Single Pole MCB - C	1/12/144	MXSPC320	240
40	40A Single Pole MCB - C	1/12/144	MXSPC400	485
63	63A Single Pole MCB - C	1/12/144	MXSPC630	485

Double Pole MCB



Rating	Description	STD.Pack	Cat No	MRP (₹) Per Unit
1	1A Double Pole MCB - C	1/6/72	MXDPC001	999
2	2A Double Pole MCB - C	1/6/72	MXDPC002	999
3	3A Double Pole MCB - C	1/6/72	MXDPC003	999
4	4A Double Pole MCB - C	1/6/72	MXDPC004	999
6	6A Double Pole MCB - C	1/6/72	MXDPC006	715
10	10A Double Pole MCB - C	1/6/72	MXDPC100	715
16	16A Double Pole MCB - C	1/6/72	MXDPC160	715
20	20A Double Pole MCB - C	1/6/72	MXDPC200	715
25	25A Double Pole MCB - C	1/6/72	MXDPC250	715
32	32A Double Pole MCB - C	1/6/72	MXDPC320	715
40	40A Double Pole MCB - C	1/6/72	MXDPC400	1035
63	63A Double Pole MCB - C	1/6/72	MXDPC630	1160

Note: D curve Available on request.

Triple Pole MCB



Rating	Description	STD.Pack	Cat No	MRP (₹) Per Unit
1	1A Triple Pole MCB - C	1/4/48	MXTPC001	1490
2	2A Triple Pole MCB - C	1/4/48	MXTPC002	1490
3	3A Triple Pole MCB - C	1/4/48	MXTPC003	1490
4	4A Triple Pole MCB - C	1/4/48	MXTPC004	1490
6	6A Triple Pole MCB - C	1/4/48	MXTPC006	1155
10	10A Triple Pole MCB - C	1/4/48	MXTPC100	1155
16	16A Triple Pole MCB - C	1/4/48	MXTPC160	1155
20	20A Triple Pole MCB - C	1/4/48	MXTPC200	1155
25	25A Triple Pole MCB - C	1/4/48	MXTPC250	1155
32	32A Triple Pole MCB - C	1/4/48	MXTPC320	1155
40	40A Triple Pole MCB - C	1/4/48	MXTPC400	1710
63	63A Triple Pole MCB - C	1/4/48	MXTPC630	1830

Four Pole MCB



Rating	Description	STD.Pack	Cat No	MRP (₹) Per Unit
1	1A Four Pole MCB - C	1/3/36	MXFPC001	1895
2	2A Four Pole MCB - C	1/3/36	MXFPC002	1895
3	3A Four Pole MCB - C	1/3/36	MXFPC003	1895
4	4A Four Pole MCB - C	1/3/36	MXFPC004	1895
6	6A Four Pole MCB - C	1/3/36	MXFPC006	1600
10	10A Four Pole MCB - C	1/3/36	MXFPC100	1600
16	16A Four Pole MCB - C	1/3/36	MXFPC160	1600
20	20A Four Pole MCB - C	1/3/36	MXFPC200	1600
25	25A Four Pole MCB - C	1/3/36	MXFPC250	1600
32	32A Four Pole MCB - C	1/3/36	MXFPC320	1600
40	40A Four Pole MCB - C	1/3/36	MXFPC400	2220
63	63A Four Pole MCB - C	1/3/36	MXFPC630	2370

RESIDUAL CURRENT CIRCUIT BREAKER



Range : 25A to 63A

- Precise sensitive range 30mA to 300mA
- 2 Pole and 4 Pole Available
- Suitable for Isolation
- Protection Degree - IP 20

Two Pole RCCB



Rating	Description	STD.Pack	Cat No	MRP (₹) Per Unit
30mA	RCCB 25A Double Pole	72	RXD030250	2665
30mA	RCCB 40A Double Pole	72	RXD030400	2770
30mA	RCCB 63A Double Pole	72	RXD030630	2930
100mA	RCCB 25A Double Pole	72	RXD100250	2665
100mA	RCCB 40A Double Pole	72	RXD100400	2770
100mA	RCCB 63A Double Pole	72	RXD100630	2930
300mA	RCCB 25A Double Pole	72	RXD300250	2665
300mA	RCCB 40A Double Pole	72	RXD300400	2770
300mA	RCCB 63A Double Pole	72	RXD300630	2930

Four Pole RCCB



Rating	Description	STD.Pack	Cat No	MRP (₹) Per Unit
30mA	RCCB 25A Four Pole	36	RXF030250	2825
30mA	RCCB 40A Four Pole	36	RXF030400	2985
30mA	RCCB 63A Four Pole	36	RXF030630	3200
100mA	RCCB 25A Four Pole	36	RXF100250	2825
100mA	RCCB 40A Four Pole	36	RXF100400	2985
100mA	RCCB 63A Four Pole	36	RXF100630	3200
300mA	RCCB 25A Four Pole	36	RXF300250	2825
300mA	RCCB 40A Four Pole	36	RXF300400	2985
300mA	RCCB 63A Four Pole	36	RXF300630	3200

DC MCB IEC 60947-2

- DC MCB : 6KA as per IEC 60947-2
- AC MCB : 10KA as per IEC 60947-2 & 60898-1
- (1 DP DC (500 V) MCB) + (1 DP AC MCB) in a Combo Pack
- Provides complete protection for DC and AC sides of solar rooftop installations



2 Pole

Rating	Description	STD.Pack	Cat No	MRP (₹) Per Unit
6	6A , Double Pole , DC MCB -C	1/4/48	MXDPDC006	875
10	10A , Double Pole , DC MCB -C	1/4/48	MXDPDC100	875
16	16A , Double Pole , DC MCB -C	1/4/48	MXDPDC160	875
20	20A , Double Pole , DC MCB -C	1/4/48	MXDPDC200	875
25	25A , Double Pole , DC MCB -C	1/4/48	MXDPDC250	875
32	32A , Double Pole , DC MCB -C	1/4/48	MXDPDC320	875
40	40A , Double Pole , DC MCB -C	1/4/48	MXDPDC400	1250
50	50A , Double Pole , DC MCB -C	1/4/48	MXDPDC500	1250
63	63A , Double Pole , DC MCB -C	1/4/48	MXDPDC630	1250

4 Pole

Rating	Description	STD.Pack	Cat No	MRP (₹) Per Unit
6	6A , Four Pole , DC MCB -C	1/4/48	MXFPDC006	1790
10	10A , Four Pole , DC MCB -C	1/4/48	MXFPDC100	1790
16	16A , Four Pole , DC MCB -C	1/4/48	MXFPDC160	1790
20	20A , Four Pole , DC MCB -C	1/4/48	MXFPDC200	1790
25	25A , Four Pole , DC MCB -C	1/4/48	MXFPDC250	1790
32	32A , Four Pole , DC MCB -C	1/4/48	MXFPDC320	1790
40	40A , Four Pole , DC MCB -C	1/4/48	MXFPDC400	2100
50	50A , Four Pole , DC MCB -C	1/4/48	MXFPDC500	2100
63	63A , Four Pole , DC MCB -C	1/4/48	MXFPDC630	2200

Combo Pack



Solar Combo

Rating	Description	STD.Pack	Cat No	MRP (₹) Per Unit
16+16	1 AC 16A DP MCB +1 DC 16A DP MCB	1/4/48	MXSCDP1616	1315
25+16	1 AC 25A DP MCB +1 DC 16A DP MCB	1/4/48	MXSCDP2516	1315
32+16	1 AC 32A DP MCB +1 DC 16A DP MCB	1/4/48	MXSCDP3216	1315
25+25	1 AC 25A DP MCB +1 DC 25A DP MCB	1/4/48	MXSCDP2525	1315
32+32	1 AC 32A DP MCB +1 DC 32A DP MCB	1/4/48	MXSCDP3232	1315

UL Miniature Circuit Breaker



UL 1077 Ideal for Domestic & Commercial applications

Supplementary Protector



UL 489 Ideal for Motor load & Industrial applications

Branch Protector

MCB - UL

Advantages

- 10 KA Short Circuit Rating
- Flame retardant and non-toxic
- Compact
- High performance
- Visible Markings
- Added Safety
- Easy installation
- Line / Load wiring can be reversible
- Captive Screws

1 Pole

Rating	STD Pack	MRP(₹)	
		UL 1077	UL 489
0.5A	10	599	792
1A	10	599	792
1.6A	10	599	792
2A	10	599	792
3A	10	599	792
4A	10	599	792
5A	10	599	792
6A	10	536	709
7A	10	536	709
8A	10	536	709
10A	10	536	709
13A	10	536	709
15A	10	536	709
16A	10	536	709
20A	10	536	709
25A	10	536	709
30A	10	536	709
32A	10	536	709
40A	10	563	744
50A	10	563	744
63A	10	563	744

1+N Pole

Rating	STD Pack	MRP(₹)	
		UL 1077	UL 489
0.5A	6	1165	1538
1A	6	1165	1538
1.6A	6	1165	1538
2A	6	1165	1538
3A	6	1165	1538
4A	6	1165	1538
5A	6	1165	1538
6A	6	1037	1375
7A	6	1037	1375
8A	6	1037	1375
10A	6	1037	1375
13A	6	1037	1375
15A	6	1037	1375
16A	6	1037	1375
20A	6	1037	1375
25A	6	1037	1375
30A	6	1037	1375
32A	6	1037	1375
40A	6	1088	1443
50A	6	1088	1443
63A	6	1088	1443



2 Pole



Rating	STD Pack	MRP(₹)	
		UL 1077	UL 489
0.5A	6	1199	1583
1A	6	1199	1583
1.6A	6	1199	1583
2A	6	1199	1583
3A	6	1199	1583
4A	6	1199	1583
5A	6	1199	1583
6A	6	1073	1418
7A	6	1073	1418
8A	6	1073	1418
10A	6	1073	1418
13A	6	1073	1418
15A	6	1073	1418
16A	6	1073	1418
20A	6	1073	1418
25A	6	1073	1418
30A	6	1073	1418
32A	6	1073	1418
40A	6	1125	1487
50A	6	1125	1487
63A	6	1125	1487

3 Pole



Rating	STD Pack	MRP(₹)	
		UL 1077	UL 489
0.5A	4	1799	2372
1A	4	1799	2372
1.6A	4	1799	2372
2A	4	1799	2372
3A	4	1799	2372
4A	4	1799	2372
5A	4	1799	2372
6A	4	1608	2130
7A	4	1608	2130
8A	4	1608	2130
10A	4	1608	2130
13A	4	1608	2130
15A	4	1608	2130
16A	4	1608	2130
20A	4	1608	2130
25A	4	1608	2130
30A	4	1608	2130
32A	4	1608	2130
40A	4	1688	2230
50A	4	1688	2230
63A	4	1688	2230

3+N Pole

Rating	STD Pack	MRP(₹)	
		UL 1077	UL 489
0.5A	3	2362	3120
1A	3	2362	3120
1.6A	3	2362	3120
2A	3	2362	3120
3A	3	2362	3120
4A	3	2362	3120
5A	3	2362	3120
6A	3	2109	2793
7A	3	2109	2793
8A	3	2109	2793
10A	3	2109	2793
13A	3	2109	2793
15A	3	2109	2793
16A	3	2109	2793
20A	3	2109	2793
25A	3	2109	2793
30A	3	2109	2793
32A	3	2109	2793
40A	3	2212	2930
50A	3	2212	2930
63A	3	2212	2930

Note : Accessories available on request, Contact Head Office



AC3	Description	Cat No	MRP (₹) Per Unit
16A	2 Pole	MS162P00XXXA	1090
25A	2 Pole	MS252P00XXXA	1215
40A	2 Pole	MS402P00XXXA	1830
	Spare Coil		530

AC3	Description	Cat No	MRP (₹) Per Unit
16A	3 Pole	MS163P00XXXA	1245
25A	3 Pole	MS252P00XXXA	1426
40A	3 Pole	MS402P00XXXA	2215
	Spare Coil		745

AC3	Description	Cat No	MRP (₹) Per Unit
16A	4 Pole	MS164P00XXXA	1430
25A	4 Pole	MS254P00XXXA	1750
40A	4 Pole	MS404P00XXXA	4000
	Spare Coil		910

Note: xxx - Voltage to be substituted

Volts	24	48	160-220	220-240	380	380-415
Code xxx	024	048	220	240	380	415

Definite Purpose(DP) Contactors



DP Contactors

Salzer H2 Series DP Contactors provide high performance with both flexibility and reliability. They are designed to match numerous applications including:

- Air conditioning
- Pumps
- Resistive heating
- Power supplies
- Refrigeration equipment
- Food service equipment
- Motors
- Compressors
- Welding
- Business machines

Amps	Description	Cat No	MRP (₹) Per Unit
20A	1 Pole	H220AXXB1B1	600
20A	2 Pole	H220BXXB1B1	800
20A	3 Pole	H220CXXB1B1	1070

Amps	Description	Cat No	MRP (₹) Per Unit
25A	1 Pole	H225AXXB1B1	670
25A	2 Pole	H225BXXB1B1	830
25A	3 Pole	H225CXXB1B1	1200

Amps	Description	Cat No	MRP (₹) Per Unit
32A	1 Pole	H232AXXB1B1	750
32A	2 Pole	H232BXXB1B1	855
32A	3 Pole	H232CXXB1B1	1550

Amps	Description	Cat No	MRP (₹) Per Unit
40A	1 Pole	H240AXXB1B1	1100
40A	2 Pole	H240BXXB1B1	1520
40A	3 Pole	H240CXXB1B1	1790

Note: xxx - Voltage to be substituted

Volts	24	120	220	170-250	415	480	600
Code xxx	024	120	220	240	415	480	600

Rotary Switches (AC/DC)

AC Switch Range: 6 - 400 Amps

Touch Proof /Rear termination/Side Termination
Standard front panel, Rear, 22.5mm Dia., Din rail, Mix and Match, Center Key lock, Pad Lock & Door Interlock switches

Breaker Control Switches: 25/32 Amps

Spring return to Neutral, Memory feature & Sequential lock.

DC Switch Range : 16-500 Amps upto 250 Volts DC



Toroidal Transformers / Current Transformers

Single Phase 15VA - 30KVA & Three Phase
1KVA - 120KVA. CT's : Accuracy Class of 0.2 to 3
with burden of 5 to 30VA, Primary Current upto
4000A & Secondary of 5A / 1A



Transformers & Chokes / Inductors / Reactor :

Dry type Magnetics - VPI, AN - AF - Water Cooling etc.
Transformers Range: 1KVA to 1MVA, 1Phase and 3Phase

Chokes / Inductors / Reactors Range:

1KVAR to 1MVA 1Phase and 3 Phase



Toroidal Inductors & Chokes

Toroidal Choke : 40 KVA to 250 KVA,
Upto 300 Amps

Power Chokes & Inductors:

Range : 0.1 to 100 mH, Upto 20 Amps



Wires & Cables

Range from 0.5 sq mm to 300 sq mm
Building Wires, Flexible Wires, Multi Core Cables,
Flat Cables, HFFR, FRLS, ZHFR Wires, UL Rated Wires,
Shielded & Braided Wires

Bunched Conductors, Tinned Copper wires &
Customised cables.



Wire Harness / Power Cords

Wire Harness for: Industrial Applications,
Consumer Electronics, Automobile Industries, Medical
Electronics. UL Approved. Power Cords as per Indian,
European & American Standards



LAN Cables & CCTV Cables

Horizontal Cable specification testing Lab

UL Listed - CM Flame Rating

ETL verified to ANSI / TIA-568.2-D Cat6

FR PVC, ROHS & REACH Compliance

Shielded / Unshielded Cat5e, Cat6, Cat6A & Cat7

CCTV Cables - for High performance Hybrid Data Transfer
offered in 3+1 & 4+1 type



Sensors

Speed Sensors : Active/Passive Sensors with Speed range
upto 30,000 rpm in Square/Sine wave output.
Position Sensors : Active/Passive Sensors with Rotation angle
0-90/0-180 & 0-360 with Analogue/Resistive output signal
Temperature Sensors : NTC/PTC types with Resistive
output signal
Pressure Sensors : Absolute/Relative pressure from
0 to 1000 bar with Ratiometric
Voltage/current output signal, with different ingress
protection of IP65/IP67/IP69K



MCB'S & Distribution Boards

MCB's are offered in various current ratings
from 0.5 to 63 Amps. Enclosures, Plug & Sockets,
Single Phase DB, Three Phase DB, Vertical DB,
Phase Selector DB, 7 & 8 Segment DB's etc.





Guarantee :

All prices are maximum retail price basis inclusive GST and any other Tax as applicable.

All the products listed in the price list carry a warranty, against manufacturing defects for a period of 18* months from the date of purchase.

The warranty is however subject to provision of proper usage, effective maintenance, it does not cover faulty operation and willful or accidental damage.

The user needs to take adequate precautions to eliminate these conditions. The manufacturer shall not be liable for any consequential loss, injury or damages attributable to defect or failure of its products.

Product development is a continuous process and hence data / prices given are subject to change without notice. Disputes if any are subject to Coimbatore jurisdiction only.

Salzer Electronics Limited

Samichettipalayam, Jothipuram Post, Coimbatore 641047. INDIA

Tel : +91-422- 4233600 | e-mail : sales@salzergroup.com

For Product Enquiries 📞 **1800 1030 161**

www.salzergroup.com