

TEKNIC



Control and Signaling Devices Ø 22.5 Metal Series

MRP with effect from 10.07.2023



Control and Signaling devices Ø22.5

Salient features

This range of Ø22.5 pushbuttons, selector switches, illuminated switches, illuminated selector switches and pilot lights have been designed to provide the following salient features:

- Economy of space
- aesthetically elegant
- SELF WIPING CONTACT
- Robust in materials of construction
- Simple to fix - screw driver is all that required
- Safe in operation
- Very good flame resistance
- Fixing method unaffected by excessive vibration-Unit does not rotate
- Shrouded terminals
- Protection against electric shock (unit earthed)

Actuators

The circular actuators have chrome plated metal bezels, and are interchangeable on the different types of contact elements.

Contact Elements

The contact elements are double break and have **self-wiping** contacts. The elements are interchangeable and can be stacked without additional hardware, 1 to 6 elements (NO or NC) can be used with non-illuminated actuators, whereas, 1 to 4 elements (NO or NC) can be used for illuminated actuators, Gold plated NO and NC contact elements for low voltage, low current switching circuits < 25 mA, are available

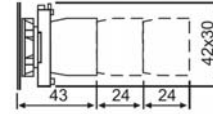

Illuminated pushbuttons and pilot lights

Pilot lights and illuminated switches are suitable for direct connection, through series resistor, through series resistor and diode, using bayonet cap filament bulb type BA9S, as follows:

Supply voltage for direct connection without series resistor: 6V-130V

Supply voltage through series resistor: 12V-415V

Supply voltage through series resistor and diode: 230V AC

Bulb.....: Filament, type BA9S with OAL max., 28 mm

LED illuminated actuators & pilot lights are available with integral LED, LED in bayonet cap suitable for operating at various voltages namely 6V, 12V, 24V, 30V, 48V, 110V, 230V, AC or DC and 415V AC. LED bulbs with bayonet cap are constructed in the standard BA9S design with OAL max. 28 mm. On request an extra short circuit protection consisting of built in fuse in the LED modules can be provided.

Pilot lights are available with but in transformers suitable for operating at 230. 110 volts AC Input and 6V, 12V and 24V output.

Terminals

Contact elements and pilot lights are designed to have shrouded terminals with combi screws,

Fixing arrangement

Fixing

The control devices Ø22.5 can be fixed in any position on panels of 1 to 6 mm thick ness. We recommend minimum fixing centers of 30 mm X 40 mm.

However, the dimensions and configuration should be decided on the basis of the application. The actuators and the lenses assemblies lock on to the holding bracket using a bayonet type of fixing which enables a simple and fast assembly. The complete assembly is locked into position on the panel by two M4 pointed screws on the bracket, lightened equally from the rear.

The screws should be tightened adequately to such an extent as to pierce through the paint on the panel from inside.

These screws also ensure the earthing of the unit.

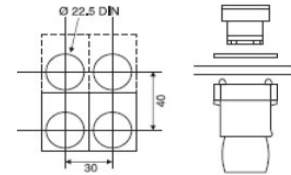

Electrical and mechanical characteristics

Environment

Standard conformity : CSA - C22.2 No. 14-95, UL508, IEC 947 • 5 (1) 1990, IS 13947
Approval : ASTA UK certified as per IEC 947 - 5 - (1) 1990

Degree of protection : IP 65 as per IEC 529, NEMA 4X, 12 as per UL 50
Ambient : - 25° C to + 70° C
Operating Position : All Position

Contact Block

Rated insulation voltage : 500 V
Rated thermal current : 10 A
Contact operation : Self wiping, slow break NO or NC

Make and break capacity

As per IEC 947 - 5 • (1) 1990 : AC 15 4A, 415V AC
: DC13 0.5A 110V DC
As per CSA - C22.2 No. 14-95, UL508 : A 600 Q600
Terminal capacity : minimum 1 x 0.5 mm², maximum 2 x 1.5 mm² or 1 x 2.5 mm²
Terminal marking : 1- 2 for NC, 3-4 for NO
Short circuit protection : 10 A cartridge fuse HRC type, rated for resistive loading
Mechanical life : Over 1 million operations
Electric rating :
(For 1 million operation cycles, operation at 3600 cycles per hour, load factor 0.5)

	V	24	120	230		V	24	110
AC 15	A	5	4	3	DC 13	A	0.5	0.2

Modules for pilot light & illuminated switches with integral LED I multichip LED bulb (BA9S cap)

Current consumptions (applicable to all colours)

24 VAC/DC, 110 VAC & 240 VAC : max.20 mA
110 VDC : max.15 mA
220 VDC : max.10 mA
Service life (at nominal voltage and at ambient temperature of 25°C) : 50,000 hours
Voltage limits (nominal voltage) : <20 % of rated voltage>
Short circuit protection : on specific request
Terminal capacity : min. 1 x 0.5 mm², max. 2 x 1.5 mm² or 1 x 2.5 mm²

Control and signalling devices Ø 22.5

Ordering instructions

- Actuators, illuminated actuators, contact elements, lense assemblies & pilot lights can all be ordered separately or in combination.
- The type numbers of contact elements are : NO: Actuator mounting : S1, S3 Note:
Individual mounting : S5, S7 S3, S4, S7, S8 are gold plated contacts
NC: Actuator mounting : S2, S4 suitable for low voltage, low current
Individual mounting : S6, S8 switching circuits < 25 mA
- Some examples of type numbers:
Actuator : Type 2AF3 is flush actuator, GREEN
Pilot light : Type 2PLB4 is pilot light without series resistor, RED
Complete pushbutton : Type 2PSF411 is flush pushbutton, RED, with 1NO+1NC contact elements

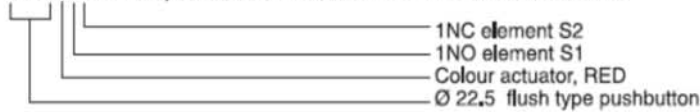

Accessories and spares

Legend plates

Legend plates 30 x 40 mm are supplied with the following standard texts:
START FORWARD UP OPEN AUTO SLOW RESET ON RIGHT TRIP
STOP REVERSE DOWN CLOSE HAND FAST INCH OFF LEFT POWER ON
Legend plate Ø 60 mm yellow with black characters for **EMERGENCY STOP**

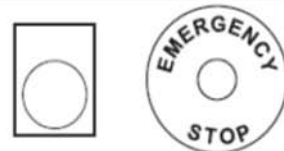

Filament bulb

Filament bulb type BA9S, OAL 28mm

Voltage	: 6	12	24	30	48	60	130
Watts	: 1	2	2	2	2	2	2,6



LED bulb

LED multichip bulb type BA9S, OAL 28mm

Colour	: White	Green	Red	Amber	Blue	Yellow	V	W
Type No. :	MCB9124	MCB9324	MCB9424	MCB9524	MCB9624	MCB9824	24	0,5
	MCB91110	MCB93110	MCB94110	MCB95110	MCB96110	MCB98110	110	1,0
	MCB91230	MCB93230	MCB94230	MCB95230	MCB96230	MCB98230	230	1,0

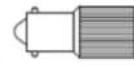

Lenses

Colour of lense	:	Translucent White	Green	Red	Amber	Blue	Clear	Yellow
For pilot lights with filament bulb		2PLL1	2PLL3	2PLL4	2PLL5	2PLL6	2PLL7	2PLL8
For illuminated actuators with filament bulb (flush/projecting)		2LAL1	2LAL3	2LAL4	2LAL5	2LAL6	2LAL7	2LAL8
For pilot lights with LED		2PLL1L	2PLL3L	2PLL4L	2PLL5L	2PLL6L	2PLL7L	2PLL8L
For illuminated actuators with LED (flush/projecting)		2LAL1L	2LAL3L	2LAL4L	2LAL5L	2LAL6L	2LAL7L	2LAL8L



Push Push mechanism for converting spring return actuator into stay put type

Type No.: 2PPM



Adaptor for fixing Ø 22.5 devices in Ø 30.5 cutout.

Type No. : 2ADP

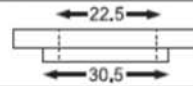

Fixing flange

Type No. : 2BRK



Padlock

For mushroom actuator : type no. 2PAM
For projecting actuator : type no. 2PAP



Boots for booted actuators

Colour of Boot : Black Green Red Blue Yellow
Type No : 2BT2 2BT3 2BT4 2BT6 2BT8



Boot for non ill. flush actuator

Colour of Boot : Clear
Type No : 2BT7



Boot for flush / proj. ill actuator

Colour of Boot : Clear
Type No : 2ALBT7



Boot for twin actuator

Colour of Boot : Clear
Type No : 2ATBT7



Boot for twin ill. actuator

Colour of Boot : Clear
Type No : 2ATLBT7



Bulb extractor

Type No. : 2BA9SE

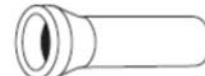

Blanking plug for Ø 22.5 hole, black

Type No. : 2BP2



MRP w.e.f. 10.07.2023

Control & Signalling Devices 22.5 Ø

METALLIC SERIES

MOMENTARY ACTUATORS





	TYPE	COLOUR	ORDERING CODE	PRICE IN Rs.
	Flush	White	2AF1	80.50
		Black	2AF2	80.50
		Green	2AF3	80.50
		Red	2AF4	80.50
		Blue	2AF6	80.50
		Yellow	2AF8	80.50
	Flush with arrow marking	White	2AF1A	105.00
		Black	2AF2A	105.00
	Projecting	White	2AP1	80.50
		Black	2AP2	80.50
		Green	2AP3	80.50
		Red	2AP4	80.50
		Blue	2AP6	80.50
		Yellow	2AP8	80.50
	Flush Relay Reset	White	2AF1RR	110.00
		Black	2AF2RR	110.00
		Green	2AF3RR	110.00
		Red	2AF4RR	110.00
		Blue	2AF6RR	110.00
		Yellow	2AF8RR	110.00
	Recess head	White	2AF1RH	130.00
		Black	2AF2RH	130.00
		Green	2AF3RH	130.00
		Red	2AF4RH	130.00
		Blue	2AF6RH	130.00
		Yellow	2AF8RH	130.00
	Booted	Black	2AB2	150.00
		Green	2AB3	150.00
		Red	2AB4	150.00
		Blue	2AB6	150.00
		Yellow	2AB8	150.00

MRP w.e.f. 10.07.2023

Control & Signalling Devices 22.5 Ø

METALLIC SERIES

MUSHROOM ACTUATORS

	TYPE	COLOUR	ORDERING CODE	PRICE IN Rs.
	Latching Ø 30mm			
		Black	2AMLS2	175.00
		Red	2AMLS4	175.00
	Momentary Ø 40mm	Black	2AM2	125.00
		Green	2AM3	125.00
		Red	2AM4	125.00
		Blue	2AM6	125.00
		Yellow	2AM8	125.00
	Latching Ø 40mm			
		Black	2AML2	175.00
		Red	2AML4	175.00
	Push-Pull Ø 40mm			
		Black	2AMPP2	175.00
		Red	2AMPP4	175.00
	Latching with Key Ø 40mm			
		Black	2AMLKB2	350.00
		Red	2AMLKB4	350.00

MRP w.e.f. 10.07.2023

Control & Signalling Devices 22.5 Ø

METALLIC SERIES

MUSHROOM ACTUATORS









	TYPE	COLOUR	ORDERING CODE	PRICE IN Rs.
	Latching Trigger Ø 40mm			
		Black	2AMLT2	260.00
		Red	2AMLT4	260.00
	Latching Trigger with key Ø 40mm			
		Black	2AMLTKB2	440.00
		Red	2AMLTKB4	440.00
	Latching Ø 60mm			
		Black	2AMLJ2	235.00
		Red	2AMLJ4	235.00
	Push-Pull Ø 60mm			
		Black	2AMPPJ2	235.00
		Red	2AMPPJ4	235.00
	Momentary Ø 60mm			
		Black	2AMJ2	175.00
		Green	2AMJ3	175.00
		Red	2AMJ4	175.00
		Blue	2AMJ6	175.00
	Yellow	2AMJ8	175.00	

MRP w.e.f. 10.07.2023

Control & Signalling Devices 22.5 Ø

METALLIC SERIES

SELECTOR ACTUATORS







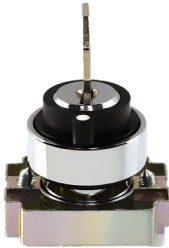

	TYPE		COLOUR	ORDERING CODE	PRICE IN Rs.
	2 position LATCHING		Black	2AS2-2P	242.00
	With ext. knob			2AS2E-2P	242.00
	MOMENTARY			2AS2-2PSR	242.00
	With ext. knob			2AS2E-2PSR	242.00
	3 position STAY PUT		Black	2AS2-3P	242.00
	With ext. knob			2AS2E-3P	242.00
	MOMENTARY on both sides			2AS2-3PSR	263.00
	With ext. knob			2AS2E-3PSR	263.00
	MOMENTARY on right			2AS2-3PSRR	263.00
	With ext. knob			2AS2E-3PSRR	263.00
	MOMENTARY on left			2AS2-3PSRL	263.00
	With ext. knob			2AS2E-3PSRL	263.00

MRP w.e.f. 10.07.2023

Control & Signalling Devices 22.5 Ø

METALLIC SERIES

KEY SELECTOR ACTUATORS

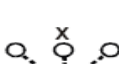
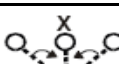
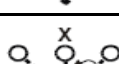
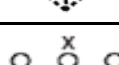
	TYPE		COLOUR	ORDERING CODE	PRICE IN Rs.	
	2 POSITION Stayput		Black	2AK2-2PB	335.00	
				2AK2-2PO	335.00	
				2AK2-2PI	335.00	
	Spring Return			2AK2-2POSR	335.00	
	3 POSITION Stayput		Black	2AK2-3PA	355.00	
				2AK2-3PO	355.00	
				2AK2-3PB	355.00	
				2AK2-3PC	355.00	
		Spring Return			2AK2-3PSR	355.00
		Right to Centre			2AK2-3PSRR	355.00
		Left to Centre			2AK2-3PSRL	355.00
	* X stands for position in which key is removable					

MRP w.e.f. 10.07.2023

Control & Signalling Devices 22.5 Ø





METALLIC SERIES

TWIN ACTUATORS

	TYPE	COLOUR	ORDERING CODE	PRICE IN Rs.
	Double Flush w/o IO Mark	Green	2ATF3F4	160.00
		Red		
		Yellow	2ATF8F2	160.00
		Black		
	Double Flush with IO Mark	Green	2ATF3F4(IO)	160.00
		Red		
		Yellow	2ATF8F2(IO)	160.00
		Black		
	1 Flush 1 Projecting w/o IO Mark	Green	2ATF3P4	160.00
		Red		
		Yellow	2ATF8P2	160.00
		Black		
	1 Flush 1 Projecting with IO Mark	Green	2ATF3P4(IO)	160.00
		Red		
		Yellow	2ATF8P2(IO)	160.00
		Black		

MRP w.e.f. 10.07.2023

Control & Signalling Devices 22.5 Ø

METALLIC SERIES				
ILLUMINATED FLUSH ACTUATOR WITH FILAMENT BULB				
	TYPE	COLOUR	ORDERING CODE	PRICE IN Rs. WITH BULB
	Illuminated Flush, Momentary			
	Filament Bulb 6V to 130V AC/DC	White	2ALF1	215.00
		Green	2ALF3	215.00
		Red	2ALF4	215.00
		Amber	2ALF5	215.00
		Blue	2ALF6	215.00
		Clear	2ALF7	215.00
		Yellow	2ALF8	215.00
Direct Connection	Please mention the voltage required after the ordering code			
	Filament Bulb 24V, 48V,110V, 230 V AC/DC	White	2ALRF1	230.00
		Green	2ALRF3	230.00
		Red	2ALRF4	230.00
		Amber	2ALRF5	230.00
		Blue	2ALRF6	230.00
		Clear	2ALRF7	230.00
		Yellow	2ALRF8	230.00
Connection with Resistor	Please mention the voltage required after the ordering code			
	Illuminated Projecting, Momentary			
	Filament Bulb 6V to 130V AC/DC	White	2ALP1	215.00
		Green	2ALP3	215.00
		Red	2ALP4	215.00
		Amber	2ALP5	215.00
		Blue	2ALP6	215.00
		Clear	2ALP7	215.00
		Yellow	2ALP8	215.00
Direct Connection	Please mention the voltage required after the ordering code			
	Filament Bulb 24V, 48V,110V, 230 V AC/DC	White	2ALRP1	230.00
		Green	2ALRP3	230.00
		Red	2ALRP4	230.00
		Amber	2ALRP5	230.00
		Blue	2ALRP6	230.00
		Clear	2ALRP7	230.00
		Yellow	2ALRP8	230.00
Connection with Resistor	Please mention the voltage required after the ordering code			









METALLIC SERIES









ILLUMINATED FLUSH ACTUATOR WITH LED/ LED BULB

	TYPE	COLOUR	ORDERING CODE	PRICE IN Rs. INTEGRAL LED	PRICE IN Rs. WITH LED BULB
	Illuminated Flush actuator, Momentary				
	Integral LED 6V, 12V, 24V, 48V AC/DC, 110VAC, 110VDC, 230VAC, 220VDC	White LED / White Lens	2ALRF1L(S)	450.00	
		Green LED / Green Lens	2ALRF3L	285.00	
		Red LED / Red Lens	2ALRF4L	285.00	
		Amber LED / Amber Lens	2ALRF5L	285.00	
		Blue LED / Blue Lens	2ALRF6L	580.00	
		White LED / Clear Lens	2ALRF7L(S)	450.00	
Yellow LED / Yellow Lens	2ALRF8L	285.00			
Integral LED	Please mention the voltage required after the ordering code				
	LED Bulb, BA9S type 24V AC/DC, 110VAC, 110VDC, 230VAC, 220VDC	White LED Bulb / White Lens	2ALF1LB(S)		510.00
		Green LED Bulb / Green Lens	2ALF3LB		280.00
		Red LED Bulb / Red Lens	2ALF4LB		280.00
		Amber LED Bulb / Amber Lens	2ALF5LB		280.00
		Blue LED Bulb / Blue Lens	2ALF6LB		545.00
		White LED Bulb / Clear Lens	2ALF7LB(S)		510.00
	Yellow LED Bulb / Yellow Lens	2ALF8LB		280.00	
LED Bulb	Please mention the voltage required after the ordering code				
	Integral LED 24V, 110V, 230V AC	White LED / White Lens	2ALRF1L(S)F	450.00	
		Green LED / Green Lens	2ALRF3LF	285.00	
		Red LED / Red Lens	2ALRF4LF	285.00	
		Amber LED / Amber Lens	2ALRF5LF	285.00	
		Blue LED / Blue Lens	2ALRF6LF	580.00	
		White LED / Clear Lens	2ALRF7L(S)F	450.00	
	Yellow LED / Yellow Lens	2ALRF8LF	285.00		
Flasher with Integral LED	Please mention the voltage required after the ordering code				
	Illuminated Projecting Actuator, Momentary				
	Integral LED 6V, 12V, 24V, 48V AC/DC, 110VAC, 110VDC, 230VAC, 220VDC	White LED / White Lens	2ALRP1L(S)	450.00	
		Green LED / Green Lens	2ALRP3L	285.00	
		Red LED / Red Lens	2ALRP4L	285.00	
		Amber LED / Amber Lens	2ALRP5L	285.00	
		Blue LED / Blue Lens	2ALRP6L	580.00	
		White LED / Clear Lens	2ALRP7L(S)	450.00	
Yellow LED / Yellow Lens	2ALRP8L	285.00			
Integral LED	Please mention the voltage required after the ordering code				
	LED Bulb, BA9S type 24V AC/DC, 110VAC, 110VDC, 230VAC, 220VDC	White LED Bulb / White Lens	2ALP1LB(S)		510.00
		Green LED Bulb / Green Lens	2ALP3LB		280.00
		Red LED Bulb / Red Lens	2ALP4LB		280.00
		Amber LED Bulb / Amber Lens	2ALP5LB		280.00
		Blue LED Bulb / Blue Lens	2ALP6LB		545.00
		White LED / Clear Lens	2ALP7L(S)		510.00
	Yellow LED Bulb / Yellow Lens	2ALP8LB		280.00	
LED Bulb	Please mention the voltage required after the ordering code				
	Integral LED 24V, 110V, 230V AC	White LED / White Lens	2ALRP1LF(S)	450.00	
		Green LED / Green Lens	2ALRP3LF	285.00	
		Red LED / Red Lens	2ALRP4LF	285.00	
		Amber LED / Amber Lens	2ALRP5LF	285.00	
		Blue LED / Blue Lens	2ALRP6LF	580.00	
		White LED / Clear Lens	2ALRP7LF(S)	450.00	
	Yellow LED / Yellow Lens	2ALRP8LF	285.00		
Flasher with Integral LED	Please mention the voltage required after the ordering code				
	Illuminated Projecting Actuator, Push to ON & Push to Release				
	Integral LED 6V, 12V, 24V, 48V AC/DC, 110VAC, 110VDC, 230VAC, 220VDC	White LED / White Lens	2ALRPPP1L(S)	605.00	
		Green LED / Green Lens	2ALRPPP3L	440.00	
		Red LED / Red Lens	2ALRPPP4L	440.00	
		Amber LED / Amber Lens	2ALRPPP5L	440.00	
		Blue LED / Blue Lens	2ALRPPP6L	730.00	
		White LED / Clear Lens	2ALRPPP7L(S)	605.00	
Yellow LED / Yellow Lens	2ALRPPP8L	440.00			
Integral LED	Please mention the voltage required after the ordering code				











MRP w.e.f. 10.07.2023

Control & Signalling Devices 22.5 Ø

METALLIC SERIES				
ILLUMINATED SELECTOR WITH FILAMENT BULB				
	TYPE	COLOUR	ORDERING CODE	PRICE IN Rs. WITH BULB
	2 Position Stayput illuminated selector actuator			
	Filament bulb 6V to 130V AC/DC	White	2ASL1-2P	390.00
		Green	2ASL3-2P	390.00
		Red	2ASL4-2P	390.00
		Amber	2ASL5-2P	390.00
		Blue	2ASL6-2P	390.00
		Clear	2ASL7-2P	390.00
		Yellow	2ASL8-2P	390.00
Direct Connection	Please mention the voltage required after the ordering code			
	Filament bulb 24 V,48V,110V, 230V AC/DC	White	2ASLR1-2P	405.00
		Green	2ASLR3-2P	405.00
		Red	2ASLR4-2P	405.00
		Amber	2ASLR5-2P	405.00
		Blue	2ASLR6-2P	405.00
		Clear	2ASLR7-2P	405.00
		Yellow	2ASLR8-2P	405.00
	Connection with Resistor	Please mention the voltage required after the ordering code		
	Filament bulb 6V to 130V AC/DC	White	2ASL1-2PSR	390.00
		Green	2ASL3-2PSR	390.00
		Red	2ASL4-2PSR	390.00
		Amber	2ASL5-2PSR	390.00
		Blue	2ASL6-2PSR	390.00
		Clear	2ASL7-2PSR	390.00
		Yellow	2ASL8-2PSR	390.00
	Direct Connection	Please mention the voltage required after the ordering code		
	Filament bulb 24 V,48V,110V, 230V AC/DC	White	2ASLR1-2PSR	405.00
		Green	2ASLR3-2PSR	405.00
		Red	2ASLR4-2PSR	405.00
		Amber	2ASLR5-2PSR	405.00
		Blue	2ASLR6-2PSR	405.00
		Clear	2ASLR7-2PSR	405.00
		Yellow	2ASLR8-2PSR	405.00
	Connection with Resistor	Please mention the voltage required after the ordering code		











METALLIC SERIES					
ILLUMINATED SELECTOR ACTUATOR WITH LED					
	TYPE	COLOUR	ORDERING CODE	PRICE IN Rs. INTEGRAL LED	PRICE IN Rs. WITH LED BULB
	2 Position Illuminated Selector Actuator				
	Integral LED 6V, 12V, 24V, 48V AC/DC, 110VAC, 110VDC, 230VAC, 220VDC 	White LED / White Lens	2ASLR1L(S)-2P	615.00	
		Green LED / Green Lens	2ASLR3L-2P	465.00	
		Red LED / Red Lens	2ASLR4L-2P	465.00	
		Amber LED / Amber Lens	2ASLR5L-2P	465.00	
		Blue LED / Blue Lens	2ASLR6L-2P	730.00	
		White LED / Clear Lens	2ASLR7L(S)-2P	615.00	
		Yellow LED / Yellow Lens	2ASLR8L-2P	465.00	
Integral LED	Please mention the voltage required after the ordering code				
	LED Bulb, BA9S type 24V AC/DC, 110VAC, 110VDC, 230VAC, 220VDC 	White LED Bulb / White Lens	2ASL1LB(S)-2P		705.00
		Green LED Bulb / Green Lens	2ASL3LB-2P		465.00
		Red LED Bulb / Red Lens	2ASL4LB-2P		465.00
		Amber LED Bulb / Amber Lens	2ASL5LB-2P		465.00
		Blue LED Bulb / Blue Lens	2ASL6LB-2P		730.00
		White LED Bulb/ Clear Lens	2ASL7LB(S)-2P		705.00
		Yellow LED Bulb / Yellow Lens	2ASL8LB-2P		465.00
	LED Bulb	Please mention the voltage required after the ordering code			
	Integral LED 6V, 12V, 24V, 48V AC/DC, 110VAC, 110VDC, 230VAC, 220VDC 	White LED / White Lens	2ASLR1L(S)-2PSR	615.00	
		Green LED / Green Lens	2ASLR3L-2PSR	465.00	
		Red LED / Red Lens	2ASLR4L-2PSR	465.00	
		Amber LED / Amber Lens	2ASLR5L-2PSR	465.00	
		Blue LED / Blue Lens	2ASLR6L-2PSR	730.00	
		White LED / Clear Lens	2ASLR7L(S)-2PSR	615.00	
		Yellow LED / Yellow Lens	2ASLR8L-2PSR	465.00	
	Integral LED	Please mention the voltage required after the ordering code			
	LED Bulb, BA9S type 24V AC/DC, 110VAC, 110VDC, 230VAC, 220VDC 	White LED Bulb / White Lens	2ASL1LB(S)-2PSR		705.00
		Green LED Bulb / Green Lens	2ASL3LB-2PSR		465.00
		Red LED Bulb / Red Lens	2ASL4LB-2PSR		465.00
		Amber LED Bulb / Amber Lens	2ASL5LB-2PSR		465.00
		Blue LED Bulb / Blue Lens	2ASL6LB-2PSR		730.00
		White LED Bulb/ Clear Lens	2ASL7LB(S)-2PSR		705.00
		Yellow LED Bulb / Yellow Lens	2ASL8LB-2PSR		465.00
	LED Bulb	Please mention the voltage required after the ordering code			

Control & Signalling Devices 22.5 Ø

METALLIC SERIES				
ILLUMINATED SELECTOR WITH FILAMENT BULB				
	TYPE	COLOUR	ORDERING CODE	PRICE IN Rs. WITH BULB
	3 Position Stayput Illuminated Selector Actuator			
	Stayput Filament bulb 6V to 130V AC/DC 	White	2ASL1-3P	410.00
		Green	2ASL3-3P	410.00
		Red	2ASL4-3P	410.00
		Amber	2ASL5-3P	410.00
		Blue	2ASL6-3P	410.00
		Clear	2ASL7-3P	410.00
		Yellow	2ASL8-3P	410.00
		Please mention the voltage required after the ordering code		
	Momentary Filament bulb 6V to 130V AC/DC 	White	2ASL1-3PSR	425.00
		Green	2ASL3-3PSR	425.00
		Red	2ASL4-3PSR	425.00
		Amber	2ASL5-3PSR	425.00
		Blue	2ASL6-3PSR	425.00
		Clear	2ASL7-3PSR	425.00
		Yellow	2ASL8-3PSR	425.00
		Please mention the voltage required after the ordering code		
	Stayput / Momentary Filament bulb 6V to 130V AC/DC 	White	2ASL1-3PSRL	425.00
		Green	2ASL3-3PSRL	425.00
		Red	2ASL4-3PSRL	425.00
		Amber	2ASL5-3PSRL	425.00
		Blue	2ASL6-3PSRL	425.00
		Clear	2ASL7-3PSRL	425.00
		Yellow	2ASL8-3PSRL	425.00
Please mention the voltage required after the ordering code				
Stayput / Momentary Filament bulb 6V to 130V AC/DC 	White	2ASL1-3PSRR	425.00	
	Green	2ASL3-3PSRR	425.00	
	Red	2ASL4-3PSRR	425.00	
	Amber	2ASL5-3PSRR	425.00	
	Blue	2ASL6-3PSRR	425.00	
	Clear	2ASL7-3PSRR	425.00	
	Yellow	2ASL8-3PSRR	425.00	
	Please mention the voltage required after the ordering code			
Direct Connection	Please mention the voltage required after the ordering code			
	3 Position Illuminated Selector Actuator			
	Stayput Filament Bulb 24V,48V,130V, 230V AC/DC 	White	2ASLR1-3P	430.00
		Green	2ASLR3-3P	430.00
		Red	2ASLR4-3P	430.00
		Amber	2ASLR5-3P	430.00
		Blue	2ASLR6-3P	430.00
		Clear	2ASLR7-3P	430.00
		Yellow	2ASLR8-3P	430.00
		Please mention the voltage required after the ordering code		
	Momentary Filament Bulb 24V,48V,130V, 230V AC/DC 	White	2ASLR1-3PSR	440.00
		Green	2ASLR3-3PSR	440.00
		Red	2ASLR4-3PSR	440.00
		Amber	2ASLR5-3PSR	440.00
		Blue	2ASLR6-3PSR	440.00
		Clear	2ASLR7-3PSR	440.00
		Yellow	2ASLR8-3PSR	440.00
		Please mention the voltage required after the ordering code		
	Stayput / Momentary Filament Bulb 24V,48V,130V, 230V AC/DC 	White	2ASLR1-3PSRL	440.00
		Green	2ASLR3-3PSRL	440.00
		Red	2ASLR4-3PSRL	440.00
		Amber	2ASLR5-3PSRL	440.00
		Blue	2ASLR6-3PSRL	440.00
		Clear	2ASLR7-3PSRL	440.00
		Yellow	2ASLR8-3PSRL	440.00
Please mention the voltage required after the ordering code				
Stayput / Momentary Filament Bulb 24V,48V,130V, 230V AC/DC 	White	2ASLR1-3PSRR	440.00	
	Green	2ASLR3-3PSRR	440.00	
	Red	2ASLR4-3PSRR	440.00	
	Amber	2ASLR5-3PSRR	440.00	
	Blue	2ASLR6-3PSRR	440.00	
	Clear	2ASLR7-3PSRR	440.00	
	Yellow	2ASLR8-3PSRR	440.00	
	Please mention the voltage required after the ordering code			
Connection with Resistor	Please mention the voltage required after the ordering code			



METALLIC SERIES

ILLUMINATED SELECTOR WITH LED

	TYPE	COLOUR	ORDERING CODE	PRICE IN Rs. INTEGRAL LED	PRICE IN Rs. WITH LED BULB		
	3 Position illuminated selector actuator						
	Stayput	White LED / White Lens	2ASLR1L(S)-3P	635.00			
	Integral LED	Green LED / Green Lens	2ASLR3L-3P	490.00			
	6V, 12V, 24V, 48V AC/DC	Red LED / Red Lens	2ASLR4L-3P	490.00			
	110VAC, 110VDC,	Amber LED / Amber Lens	2ASLR5L-3P	490.00			
	230VAC, 220VDC	Blue LED / Blue Lens	2ASLR6L-3P	740.00			
		White LED / Clear Lens	2ASLR7L(S)-3P	635.00			
		Yellow LED / Yellow Lens	2ASLR8L-3P	490.00			
	Please mention the voltage required after the ordering code						
	Momentary	White LED / White Lens	2ASLR1L(S)-3PSR	775.00			
	Integral LED	Green LED / Green Lens	2ASLR3L-3PSR	605.00			
	6V, 12V, 24V, 48V AC/DC	Red LED / Red Lens	2ASLR4L-3PSR	605.00			
	110VAC, 110VDC,	Amber LED / Amber Lens	2ASLR5L-3PSR	605.00			
	230VAC, 220VDC	Blue LED / Blue Lens	2ASLR6L-3PSR	900.00			
		White LED / Clear Lens	2ASLR7L(S)-3PSR	775.00			
		Yellow LED / Yellow Lens	2ASLR8L-3PSR	605.00			
	Please mention the voltage required after the ordering code						
	Stayput / Momentary	White LED / White Lens	2ASLR1L(S)-3PSRL	775.00			
	Integral LED	Green LED / Green Lens	2ASLR3L-3PSRL	605.00			
	6V, 12V, 24V, 48V AC/DC	Red LED / Red Lens	2ASLR4L-3PSRL	605.00			
	110VAC, 110VDC,	Amber LED / Amber Lens	2ASLR5L-3PSRL	605.00			
	230VAC, 220VDC	Blue LED / Blue Lens	2ASLR6L-3PSRL	900.00			
		White LED / Clear Lens	2ASLR7L(S)-3PSRL	775.00			
		Yellow LED / Yellow Lens	2ASLR8L-3PSRL	605.00			
	Please mention the voltage required after the ordering code						
	Stayput / Momentary	White LED / White Lens	2ASLR1L(S)-3PSRR	775.00			
	Integral LED	Green LED / Green Lens	2ASLR3L-3PSRR	605.00			
	6V, 12V, 24V, 48V AC/DC	Red LED / Red Lens	2ASLR4L-3PSRR	605.00			
	110VAC, 110VDC,	Amber LED / Amber Lens	2ASLR5L-3PSRR	605.00			
	230VAC, 220VDC	Blue LED / Blue Lens	2ASLR6L-3PSRR	900.00			
		White LED / Clear Lens	2ASLR7L(S)-3PSRR	775.00			
		Yellow LED / Yellow Lens	2ASLR8L-3PSRR	605.00			
	Integral LED	Please mention the voltage required after the ordering code					
		3 Position illuminated selector actuator with LED Bulb					
		Stayput	White LED Bulb / White Lens	2ASL1LB(S)-3P		725.00	
		LED Bulb, BA9S type	Green LED Bulb / Green Lens	2ASL3LB-3P		480.00	
		24V AC/DC,	Red LED Bulb / Red Lens	2ASL4LB-3P		480.00	
		110VAC, 110VDC	Amber LED Bulb / Amber Lens	2ASL5LB-3P		480.00	
		230VAC, 220VDC	Blue LED Bulb / Blue Lens	2ASL6LB-3P		755.00	
			White LED Bulb / Clear Lens	2ASL7LB(S)-3P		725.00	
			Yellow LED Bulb / Yellow Lens	2ASL8LB-3P		480.00	
		Please mention the voltage required after the ordering code					
		Momentary	White LED Bulb / White Lens	2ASL1LB(S)-3PSR		735.00	
		LED Bulb, BA9S type	Green LED Bulb / Green Lens	2ASL3LB-3PSR		495.00	
		24V AC/DC,	Red LED Bulb / Red Lens	2ASL4LB-3PSR		495.00	
110VAC, 110VDC		Amber LED Bulb / Amber Lens	2ASL5LB-3PSR		495.00		
230VAC, 220VDC		Blue LED Bulb / Blue Lens	2ASL6LB-3PSR		765.00		
		White LED Bulb / Clear Lens	2ASL7LB(S)-3PSR		735.00		
		Yellow LED Bulb / Yellow Lens	2ASL8LB-3PSR		495.00		
Please mention the voltage required after the ordering code							
Stayput / Momentary		White LED Bulb / White Lens	2ASL1LB(S)-3PSRL		735.00		
LED Bulb, BA9S type		Green LED Bulb / Green Lens	2ASL3LB-3PSRL		495.00		
24V AC/DC,		Red LED Bulb / Red Lens	2ASL4LB-3PSRL		495.00		
110VAC, 110VDC		Amber LED Bulb / Amber Lens	2ASL5LB-3PSRL		495.00		
230VAC, 220VDC		Blue LED Bulb / Blue Lens	2ASL6LB-3PSRL		765.00		
		White LED Bulb / Clear Lens	2ASL7LB(S)-3PSRL		735.00		
		Yellow LED Bulb / Yellow Lens	2ASL8LB-3PSRL		495.00		
Please mention the voltage required after the ordering code							
Stayput / Momentary		White LED Bulb / White Lens	2ASL1LB(S)-3PSRR		735.00		
LED Bulb, BA9S type		Green LED Bulb / Green Lens	2ASL3LB-3PSRR		495.00		
24V AC/DC,		Red LED Bulb / Red Lens	2ASL4LB-3PSRR		495.00		
110VAC, 110VDC		Amber LED Bulb / Amber Lens	2ASL5LB-3PSRR		495.00		
230VAC, 220VDC		Blue LED Bulb / Blue Lens	2ASL6LB-3PSRR		765.00		
		White LED Bulb / Clear Lens	2ASL7LB(S)-3PSRR		735.00		
		Yellow LED Bulb / Yellow Lens	2ASL8LB-3PSRR		495.00		
LED Bulb		Please mention the voltage required after the ordering code					

MRP w.e.f. 10.07.2023

Control & Signalling Devices 22.5 Ø

METALLIC SERIES					
PILOT LIGHTS WITH FILAMENT BULB					
	TYPE	COLOUR	ORDERING CODE	PRICE IN Rs. WITH BULB	
	Pilot Light				
	Filament Bulb 6V to 130V AC/DC	White	2PLB1	170.00	
		Green	2PLB3	170.00	
		Red	2PLB4	170.00	
		Amber	2PLB5	170.00	
		Blue	2PLB6	170.00	
		Clear	2PLB7	170.00	
		Yellow	2PLB8	170.00	
Direct Connection	Please mention the voltage required after the ordering code				
	Filament Bulb 24V,48V,110V, 230V AC/DC	White	2PLBR1	205.00	
		Green	2PLBR3	205.00	
		Red	2PLBR4	205.00	
		Amber	2PLBR5	205.00	
		Blue	2PLBR6	205.00	
		Clear	2PLBR7	205.00	
		Yellow	2PLBR8	205.00	
Connection with Resistor	Please mention the voltage required after the ordering code				
	Filament Bulb				
	Primary volt.	Sec. Volt.	White	2PLBT1XX/YYY	515.00
	110 VAC	6	Green	2PLBT3XX/YYY	515.00
	110 VAC	12	Red	2PLBT4XX/YYY	515.00
	110 VAC	24	Amber	2PLBT5XX/YYY	515.00
	Primary volt.	Sec. Volt.	Blue	2PLBT6XX/YYY	515.00
	240 VAC	6	Clear	2PLBT7XX/YYY	515.00
	240 VAC	12	Yellow	2PLBT8XX/YYY	515.00
	240 VAC	24			
Connection with Transformer	XX - Primary Voltage YYY - Secondary Voltage				





METALLIC SERIES					
PILOT LIGHTS					
	TYPE	COLOUR	ORDERING CODE	PRICE IN Rs. INTEGRAL LED	PRICE IN Rs. WITH LED BULB
	Pilot Light with Integral LED				
	Integral LED 6V, 12V, 24V, 48V AC/DC, 110VAC, 110VDC, 230VAC, 220VDC	White LED / White Lens	2PLBR1L(S)	415.00	
		Green LED / Green Lens	2PLBR3L	245.00	
		Red LED / Red Lens	2PLBR4L	245.00	
		Amber LED / Amber Lens	2PLBR5L	245.00	
		Blue LED / Blue Lens	2PLBR6L	550.00	
		White LED / Clear Lens	2PLBR7L(S)	415.00	
	Yellow LED / Yellow Lens	2PLBR8L	245.00		
Integral LED	Please mention the voltage required after the ordering code				
	Integral LED, Flasher 6V, 12V, 24V, 48V AC/DC, 110VAC, 110VDC, 230VAC, 220VDC	White LED / White Lens	2PLBR1LF(S)	415.00	
		Green LED / Green Lens	2PLBR3LF	245.00	
		Red LED / Red Lens	2PLBR4LF	245.00	
		Amber LED / Amber Lens	2PLBR5LF	245.00	
		Blue LED / Blue Lens	2PLBR6LF	550.00	
		White LED / Clear Lens	2PLBR7LF(S)	415.00	
		Yellow LED / Yellow Lens	2PLBR8LF	245.00	
Flasher	Please mention the voltage required after the ordering code				
	Integral LED, Universal 24V upto 240V AC / DC	White LED / White Lens	2PLBR1LU(S)	570.00	
		Green LED / Green Lens	2PLBR3LU	440.00	
		Red LED / Red Lens	2PLBR4LU	440.00	
		Amber LED / Amber Lens	2PLBR5LU	440.00	
		Blue LED / Blue Lens	2PLBR6LU	685.00	
		White LED / Clear Lens	2PLBR7LU(S)	570.00	
	Yellow LED / Yellow Lens	2PLBR8LU	440.00		
Universal	Please mention the voltage required after the ordering code				
	Integral LED 415VAC	White LED / White Lens	2PLBR1L(S)	475.00	
		Green LED / Green Lens	2PLBR3L	305.00	
		Red LED / Red Lens	2PLBR4L	305.00	
		Amber LED / Amber Lens	2PLBR5L	305.00	
		Blue LED / Blue Lens	2PLBR6L	605.00	
		White LED / Clear Lens	2PLBR7L(S)	475.00	
	Yellow LED / Yellow Lens	2PLBR8L	305.00		
Integral LED	Please mention the voltage required after the ordering code				
	Pilot Light with LED Bulb				
	LED Bulb, BA9S type 24V AC/DC, 110VAC, 110VDC, 230VAC, 220VDC	White LED Bulb / White Lens	2PLB1LB(S)		470.00
		Green LED Bulb / Green Lens	2PLB3LB		245.00
		Red LED Bulb / Red Lens	2PLB4LB		245.00
		Amber LED Bulb / Amber Lens	2PLB5LB		245.00
		Blue LED Bulb / Blue Lens	2PLB6LB		500.00
		White LED Bulb / Clear Lens	2PLB7LB(S)		470.00
	Yellow LED Bulb / Yellow Lens	2PLB8LB		245.00	
LED Bulb	Please mention the voltage required after the ordering code				
	LED Bulb, BA9S type				
	Primary volt. Sec. Volt.	White LED Bulb / White Lens	2PLBT1LB(S)XX / YYY		765.00
	110 VAC 6	Green LED Bulb / Green Lens	2PLBT3LBXX / YYY		530.00
	110 VAC 12	Red LED Bulb / Red Lens	2PLBT4LBXX / YYY		530.00
	110 VAC 24	Amber LED Bulb / Amber Lens	2PLBT5LBX X/ YYY		530.00
	Primary volt. Sec. Volt.	Blue LED Bulb / Blue Lens	2PLBT6LBXX / YYY		795.00
	240 VAC 6	White LED Bulb / Clear Lens	2PLBT7LB(S)XX / YYY		765.00
	240 VAC 12	Yellow LED Bulb / Yellow Lens	2PLBT8LBXX / YYY		530.00
240 VAC 24					
Connection with Transformer	XX - Primary Voltage YYY - Secondary Voltage				





MRP w.e.f. 10.07.2023

Control & Signalling Devices 22.5 Ø

METALLIC SERIES



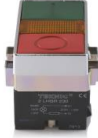

TWIN ILLUMINATED ACTUATORS WITH FILAMENT BULB

	TYPE	COLOUR	ORDERING CODE	PRICE IN Rs. WITH BULB
	Twin Illuminated 1 Flush, 1 Projecting (IO) Mark			
	Filament bulb 6V to 130V AC/DC	Red button	2ATL5F3P4 (IO)	300.00
		Green button		
		Amber lens		
Direct Connection	Please mention the voltage required after the ordering code			
	Filament bulb 24 V,48V,110V, 230V AC/DC	Red button	2ATLR5F3P4 (IO)	335.00
		Green button		
		Amber lens		
	Connection with Resistor	Please mention the voltage required after the ordering code		
	Twin Illuminated Double Flush, (IO) Mark			
	Filament bulb 6V to 130V AC/DC	Red button	2ATL5F3F4 (IO)	300.00
		Green button		
		Amber lens		
Direct Connection	Please mention the voltage required after the ordering code			
	Filament bulb 24 V,48V,110V, 230V AC/DC	Red button	2ATLR5F3F4 (IO)	335.00
		Green button		
		Amber lens		
	Connection with Resistor	Please mention the voltage required after the ordering code		

METALLIC SERIES					
TWIN ILLUMINATED ACTUATORS WITH LED					
	TYPE	COLOUR	ORDERING CODE	PRICE IN Rs. INTEGRAL LED	PRICE IN Rs. WITH LED BULB
	Twin Illuminated 1 Flush, 1 Projecting (IO) Mark				
	Integral LED 6V, 12V, 24V, 48V AC/DC, 110VAC, 110VDC, 230VAC, 220VDC	Green	2ATLR5LF3P4 (IO)	375.00	
		Red			
		Amber lens			
Integral LED	Please mention the voltage required after the ordering code				
	LED Bulb,BA9S type 24V AC/DC, 110VAC, 110VDC, 230VAC, 220VDC	Green	2ATL5LBF3P4 (IO)	375.00	375.00
		Red			
		Amber lens			
	LED Bulb	Please mention the voltage required after the ordering code			
Twin Illuminated Double Flush, (IO) Mark					
	Integral LED 6V, 12V, 24V, 48V AC/DC, 110VAC, 110VDC, 230VAC, 220VDC	Green	2ATLR5LF3F4 (IO)	375.00	
		Red			
		Amber lens			
	Integral LED	Please mention the voltage required after the ordering code			
	LED Bulb,BA9S type 24V AC/DC, 110VAC, 110VDC, 230VAC, 220VDC	Green	2ATL5LBF3F4 (IO)	375.00	375.00
		Red			
		Amber lens			
	LED Bulb	Please mention the voltage required after the ordering code			

MRP w.e.f. 10.07.2023

Control & Signalling Devices 22.5 Ø





METALLIC SERIES				
ILLUMINATED MUSHROOM WITH BULB				
	TYPE	COLOUR	ORDERING CODE	PRICE IN Rs. WITH BULB
	Illuminated Mushroom, Momentary			
	Filament bulb 6V to 130V AC/DC	Red	2ALM4	400.00
Direct Connection	Please mention the voltage required after the ordering code			
	Illuminated Mushroom, Momentary			
	Filament bulb 24 V,48V,110V, 230V AC/DC	Red	2ALRM4	425.00
Connection with Resistor	Please mention the voltage required after the ordering code			
	Illuminated Mushroom, Push Pull			
	Filament bulb 6V to 130V AC/DC	Red	2ALMPP4	450.00
Direct Connection	Please mention the voltage required after the ordering code			
	Illuminated Mushroom, Push Pull			
	Filament bulb 24 V,48V,110V, 230V AC/DC	Red	2ALRMPP4	470.00
Connection with Resistor	Please mention the voltage required after the ordering code			

MRP w.e.f. 10.07.2023

Control & Signalling Devices 22.5 Ø

METALLIC SERIES

ILLUMINATED MUSHROOM WITH LED

	TYPE	COLOUR	ORDERING CODE	PRICE IN Rs. INTEGRAL LED	PRICE IN Rs. WITH LED BULB
	Illuminated Mushroom, Momentary				
	Integral LED 6V, 12V, 24V, 48V AC/DC, 110VAC, 110VDC, 230VAC, 220VDC	Red	2ALRM4L	480.00	
Integral LED	Please mention the voltage required after the ordering code				
	LED Bulb, BA9S type 24V AC/DC, 110VAC, 110VDC, 230VAC, 220VDC	Red	2ALM4LB		480.00
LED Bulb	Please mention the voltage required after the ordering code				
	Illuminated Mushroom, Push Pull				
	Integral LED 6V, 12V, 24V, 48V AC/DC, 110VAC, 110VDC, 230VAC, 220VDC	Red	2ALRMPP4L	530.00	
Integral LED	Please mention the voltage required after the ordering code				
	LED Bulb, BA9S type 24V AC/DC, 110VAC, 110VDC, 230VAC, 220VDC	Red	2ALMPP4LB		545.00
LED Bulb	Please mention the voltage required after the ordering code				

MRP w.e.f. 10.07.2023

Control & Signalling Devices 22.5 Ø

METALLIC SERIES

CONTACT ELEMENTS

	TYPE	ORDERING CODE	PRICE IN Rs.
PANEL MOUNTING			
	NORMALLY OPEN (NO) SILVER CONTACT	S1	72.50
	NORMALLY OPEN (NO) SILVER CONTACT (BREAK BEFORE MAKE)	S1S	72.50
	NORMALLY OPEN (NO) SILVER CONTACT (MAKE BEFORE BREAK)	S1E	72.50
	NORMALLY CLOSED (NC) SILVER CONTACT	S2	72.50
	NORMALLY OPEN (NO) GOLD CONTACT	S3	195.00
	NORMALLY CLOSED (NC) GOLD CONTACT	S4	195.00
BASE MOUNTING			
	NORMALLY OPEN (NO) SILVER CONTACT	S5	72.50
	NORMALLY CLOSED (NC) SILVER CONTACT	S6	72.50
	NORMALLY OPEN (NO) GOLD CONTACT	S7	195.00
	NORMALLY CLOSED (NC) GOLD CONTACT	S8	195.00

Common types of control and signalling devices Ø 22.5

Description	Type of Actuator or Lense Assembly	Colour of Actuator or Lense	Contact Elements NO = S1 NC = S2 or Lamp Holder	Type of complete Control or Signalling Device	
Flush Pushbutton	2AF3	Green	1NO	2PSF310	
	2AF8	Yellow	2NO+1NC	2PSF821	
Projecting Pushbutton	2AP2	Black	2NC	2PSP202	
	2AP4	Red	3NO+3NC	2PSP433	
Mushroom Pushbutton Spring return	2AM2	Black	1NO+1NC	2PSM211	
	2AM4	Red	1NC	2PSM401	
Mushroom Pushbutton latching turn to release	2AML2	Black	1NC	2PSML201	
	2AML4	Red	2NO+2NC	2PSML422	
Mushroom Pushbutton latching, key to release	2AMLKB4	Red	1NO+1NC	2PSMLKB411	
Selector Actuator(2Pos)	2AS2-2P	Black	1NO	2PSS210-2P	
Selector Actuator(3Pos)	2AS2-3P	Red	1NO+1NC	2PSS211-3P	
Key Actuator (2Pos), Key withdrawable in both positions	2AK2-2PB		1NO	2PSK210-2PB	
Key Actuator (3Pos), Key withdrawable in left & right positions	2AK2-3PB		1NO+1NC	2PSK211-3PB	
Selector Illuminated Pushbutton, 2 position with resistance and diode (230V)	2ASLR3-2P230AC	Green	1NO+1NC + 2LHBR230AC	2PSSLR311-2P230AC	
Selector Illuminated Pushbutton, 3 Position with resistance (24V)	2ASLR4-3P24	Red	1NO+1NC + 2LHBR24	2PSSLR411-3P24	
Pilot Light for direct connection upto 130V	2LA3	Green	2LHB24	2PLB324	
	2LA4	Red	2LHB130	2PLB4130	
Pilot Light through resistor and diode for 230 V AC. Bulb:130V.	2LA5	Amber	2LHBR230AC	2PLBR5230AC	
	2LA6	Blue	2LHBR230AC	2PLBR6230AC	
Pilot Light with transformer for 230 V Bulb:24 V.	2LA4	Red	2LHBT230/24	2PLBT4230/24	
	2LA3	Green	2LHBT230/24	2PLBT3230/24	
Flush Illuminated Pushbutton with integral LED for 24 V DC	2ALRF3L24DC	Green	1NO+1NC + 2LHLR24DC	2PSLRF3L1124DC	
Projecting Illuminated Pushbutton with integral LED 230 V AC	2ALRP4L230AC	Red	1NO+1NC + 2LHLR230AC	2PSLRP4L11230AC	
Pilot Light with LED bulb for 110 V Bulb:110 V	2LAL5	Amber	2LHLB110	2PLB5LB110	
Twin Pushbutton marked "I O"	2ATF2-F4-IO	Flush-Black	1 NO	2PSTF210-F401-IO	
Flush - Flush		Flush-Red	1 NC		
Twin Pushbutton not marked	2ATF3-P4	Flush-Green	1NO+1NC	2PSTF311-P411	
Flush - Projecting		Proj-Red	1NO+1NC		
Twin Illuminated Pushbutton marked "I O" Flush - Flush direct connection (130V)	2ATL3-F2-F4 IO130	Lense-Green Flush-Black Flush-Red	2LHB130 1 NO + 1 NC 1 NC	2PSTL3F211-F401-IO130	
Twin Illuminated Pushbutton not marked Flush - Projecting with resistance (24V)	2ATLR5-F3-P424	Lense-Amber Flush-Green Proj-Red	2LHBR24 1 NO 1 NC	2PSTLR5F310-P40124	



GENERAL TERMS AND CONDITIONS

General Terms : Prices are ex-works Mumbai
HSN CODE : 85365010 for all the products of this MRP List
GST : 18%

Prices are subject to revision without notice and ruling at the time of delivery.

This price list supersedes all previous Price Lists.

Warranty Policy : TEKNIC equipment is guaranteed under the following terms:

For a period of 12 months from the date of sale, TEKNIC guarantees that its products are free from defects in material and workmanship, with the exception of consumables rendered unserviceable through normal use. During the said period, TEKNIC will replace or repair all parts acknowledged as defective due to factory workmanship and which have been returned in a timely manner by Buyer to TEKNIC and all costs and duties paid, together with a detailed description of the failure and a certified declaration of the number of hours of operation. Repaired or replaced parts will be redelivered FCA (named place) as per INCOTERMS 2000. This warranty is subject to the provision of correct usage, proper maintenance and does not cover defects arising out of fire, faulty operation, accident, inefficient maintenance and willful or accidental damage.

TEKNIC guarantee applies to all equipment, parts and components stored, installed, protected, maintained and used in accordance with TEKNIC specifications and instructions, and respecting the rules for normal use, without any modification by Buyer.

All other conditions or warranties, whether express or implied, relating to the quality and operation of the equipment are excluded, as well as any liability for loss or damage caused directly or indirectly by the equipment or resulting from its use.

Proof of purchase to be provided to avail warranty.

TEKNIC ELECTRIC (I) PVT. LTD.

Reg.Office : 116, Hammersmith Industrial Estate, Mahim (W), Mumbai – 400016.

Head Office : 703/704/705, Madhava, Bandra Kurla Complex, Bandra (E), Mumbai – 400051. Tel : +91-22-42532500

Works : 65, Marol Co-op. Industrial Estate Ltd., M. Vassanji Road, Andheri (East), Mumbai – 400059. Tel : +91-22-42534500

Email : teknico@teknico.co.in mfg@teknico.co.in Website : www.teknico.co.in

Control and Signaling Devices Ø 22.5 Plastic Series

MRP with effect from 10.07.2023



Control and Signaling devices Ø22.5 P Series

Salient features

This range of Ø22.5 pushbuttons, selector switches, illuminated switches, illuminated selector switches and pilot lights have been designed to provide the following salient features:

- Economy of space
- aesthetically elegant
- SELF WIPING CONTACT
- Robust in materials of construction
- Simple to fix - screw driver is all that required
- Safe in operation
- Very good flame resistance
- Fixing method unaffected by excessive vibration-Unit does not rotate
- Shrouded terminals
- Protection against electric shock (unit earthed)

Actuators

The circular actuators have black plastic bezels, and are functionally interchangeable on the different types of contact elements.

Contact Elements

The contact elements are double break and have **self-wiping** contacts. The elements are interchangeable and can be stacked without additional hardware, 1 to 6 elements (NO or NC) can be used with non-illuminated actuators, whereas, 1 to 4 elements (NO or NC) can be used for illuminated actuators, Gold plated NO and NC contact elements for low voltage, low current switching circuits < 25 mA, are available

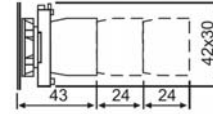

Illuminated pushbuttons and pilot lights

Pilot lights and illuminated switches are suitable for direct connection, through series resistor, through series resistor and diode, using bayonet cap filament bulb type BA9S, as follows:

Supply voltage for direct connection without series resistor: 6V-130V

Supply voltage through series resistor: 12V-415V

Supply voltage through series resistor and diode: 230V AC

Bulb.....: Filament, type BA9S with OAL max., 28 mm

LED illuminated actuators & pilot lights are available with integral LED, LED in bayonet cap suitable for operating at various voltages namely 6V, 12V, 24V, 30V, 48V, 110V, 230V, AC or DC and 415V AC. LED bulbs with bayonet cap are constructed in the standard BA9S design with OAL max. 28 mm. On request an extra short circuit protection consisting of built in fuse in the LED modules can be provided.

Pilot lights are available with but in transformers suitable for operating at 230. 110 volts AC Input and 6V, 12V and 24V output.

Terminals

Contact elements and pilot lights are designed to have shrouded terminals with combi screws,

Fixing

The P Series control devices Ø22.5 can be fixed in any position on panels of 1 to 5 mm thickness. We recommend minimum fixing centres of 30mm x 40 mm

However, the dimensions and configuration should be decided on the basis of the application. The actuators and the lense assemblies lock on the holding bracket. Details of the assembly shown in diagram.

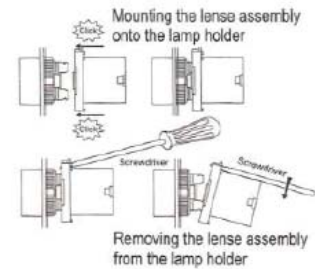
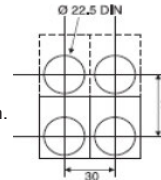

Electrical and mechanical characteristics

Environment

Standard conformity : CSA - C22.2 No. 14-95, UL508, IEC 947 • 5 (1) 1990, IS 13947
Approval : ASTA UK certified as per IEC 947 - 5 - (1) 1990

Degree of protection : IP 65 as per IEC 529, NEMA 4X, 12 as per UL 50
Ambient : - 25° C to + 70° C
Operating Position : All Position

Contact Block

Rated insulation voltage : 500 V
Rated thermal current : 10 A
Contact operation : Self wiping, slow break NO or NC

Make and break capacity

As per IEC 947 - 5 • (1) 1990 : AC 15 4A, 415V AC
: DC13 0.5A 110V DC
As per CSA - C22.2 No. 14-95, UL508 : A 600 Q600
Terminal capacity : minimum 1 x 0.5 mm², maximum 2 x 1.5 mm² or 1 x 2.5 mm²
Terminal marking : 1- 2 for NC, 3-4 for NO
Short circuit protection : 10 A cartridge fuse HRC type, rated for resistive loading
Mechanical life : Over 1 million operations
Electric rating :
(For 1 million operation cycles, operation at 3600 cycles per hour, load factor 0.5)

AC 15	V	24	120	230	DC 13	V	24	110
	A	5	4	3		A	0.5	0.2

Modules for pilot light & illuminated switches with integral LED I multichip LED bulb (BA9S cap)

Current consumptions (applicable to all colours)

24 VAC/DC, 110 VAC & 240 VAC : max.20 mA
110 VDC : max.15 mA
220 VDC : max.10 mA
Service life (at nominal voltage and at ambient temperature of 25°C) : 50,000 hours
Voltage limits (nominal voltage) : <20 % of rated voltage>
Short circuit protection : on specific request
Terminal capacity : min. 1 x 0.5 mm², max. 2 x 1.5 mm² or 1 x 2.5 mm²

Control and signalling devices Ø 22.5 P series

Ordering instructions

- Actuators, illuminated actuators, contact elements, lense assemblies & pilot lights can all be ordered separately or in combination.
- Prefix P2 for all actuators and combinations indicates Ø 22.5 P series.
The type numbers of contact elements are : NO: Actuator mounting : S1, S3 Note:
Individual mounting : S5, S7 S3, S4, S7, S8 are gold plated contacts
NC: Actuator mounting : S2, S4 suitable for low voltage, low current
Individual mounting : S6, S8 switching circuits < 25 mA

3. Some examples of type numbers:

Actuator :Type P2AF3 is flush actuator, GREEN
Pilot light :Type P2PLB4 is pilot light without series resistor, RED
Complete pushbutton :Type P2PSF411 is flush pushbutton, RED, with 1NO+1NC contact elements
1NC element S2
1NO element S1
Colour actuator, RED
Ø 22.5 flush type pushbutton

Accessories and spares

Legend plates

Legend plates 30 x 40 mm are supplied with the following standard texts:
START FORWARD UP OPEN AUTO SLOW RESET ON RIGHT TRIP
STOP REVERSE DOWN CLOSE HAND FAST INCH OFF LEFT POWER ON
Legend plate Ø 60 mm yellow with black characters for **EMERGENCY STOP**



Filament bulb

Filament bulb type BA9S, OAL 28mm

Voltage	: 6	12	24	30	48	60	130
Watts	: 1	2	2	2	2	2	2.6

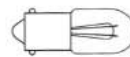

LED bulb

LED multichip bulb type BA9S, OAL 28mm

Colour	: White	Green	Red	Amber	Blue	Yellow	V	W
Type No.	: MCB9124	MCB9324	MCB9424	MCB9524	MCB9624	MCB9824	24	0.5
	MCB91110	MCB93110	MCB94110	MCB95110	MCB96110	MCB98110	110	1.0
	MCB91230	MCB93230	MCB94230	MCB95230	MCB96230	MCB98230	230	1.0

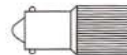

Lenses

Colour of lense : Translucent White Green Red Amber Blue Clear Yellow

For pilot lights with filament bulb	2PLL1	2PLL3	2PLL4	2PLL5	2PLL6	2PLL7	2PLL8	
For illuminated actuators with filament bulb (flush/projecting)	2LAL1	2LAL3	2LAL4	2LAL5	2LAL6	2LAL7	2LAL8	
For pilot lights with LED	2PLL1L	2PLL3L	2PLL4L	2PLL5L	2PLL6L	2PLL7L	2PLL8L	
For illuminated actuators with LED (flush/projecting)	2LAL1L	2LAL3L	2LAL4L	2LAL5L	2LAL6L	2LAL7L	2LAL8L	

Adaptor for fixing Ø 22.5 devices in Ø 30.5 cutout.

Type No. : 2ADP

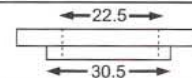

Fixing flange

Type No. : P2BRK



Padlock

For mushroom actuator : type no. 2PAM

For projecting actuator : type no. 2PAP



Boot for non ill. flush actuator

Colour of Boot : Clear

Type No : 2BT7



Boot for flush / projecting illuminated actuator

Colour of Boot : Clear

Type No : 2ALBT7



Boot for twin actuator

Colour of Boot : Clear

Type No : 2ATBT7



Boot for twin illuminated actuator

Colour of Boot : Clear

Type No : 2ATLBT7



Bulb extractor

Type No. : 2BA9SE



Blanking plug for Ø 22.5 hole, black

Type No. : 2BP2



MRP w.e.f. 10.07.2023

Control & Signalling Devices 22.5 Ø

PLASTIC SERIES

MOMENTARY ACTUATORS



	TYPE	COLOUR	ORDERING CODE	PRICE IN Rs.
	Flush	White	P2AF1	62.00
		Black	P2AF2	62.00
		Green	P2AF3	62.00
		Red	P2AF4	62.00
		Blue	P2AF6	62.00
		Yellow	P2AF8	62.00
	Projecting	White	P2AP1	62.00
		Black	P2AP2	62.00
		Green	P2AP3	62.00
		Red	P2AP4	62.00
		Blue	P2AP6	62.00
		Yellow	P2AP8	62.00
	Flush with arrow marking	White	P2AF1A	90.00
		Black	P2AF2A	90.00
	Flush Relay Reset	White	P2AF1RR	85.00
		Black	P2AF2RR	85.00
		Green	P2AF3RR	85.00
		Red	P2AF4RR	85.00
		Blue	P2AF6RR	85.00
		Yellow	P2AF8RR	85.00
	Booted	White	P2AF1BT7	135.00
		Black	P2AF2BT7	135.00
		Green	P2AF3BT7	135.00
		Red	P2AF4BT7	135.00
		Blue	P2AF6BT7	135.00
		Yellow	P2AF8BT7	135.00

MRP w.e.f. 10.07.2023

Control & Signalling Devices 22.5 Ø

PLASTIC SERIES

MUSHROOM HEAD ACTUATORS

	TYPE	COLOUR	ORDERING CODE	PRICE IN Rs.
	Latching Ø 30mm			
		Black	P2AMLS2	145.00
		Red	P2AMLS4	145.00
	Momentary Ø 40mm	Black	P2AM2	105.00
		Green	P2AM3	105.00
		Red	P2AM4	105.00
		Blue	P2AM6	105.00
		Yellow	P2AM8	105.00
	Push-Pull Ø 40mm	Black	P2AMPP2	145.00
		Red	P2AMPP4	145.00
	Latching Ø 40mm	Black	P2AML2	145.00
		Red	P2AML4	145.00
	Latching with Key Ø 40mm	Black	P2AMLKB2	285.00
		Red	P2AMLKB4	285.00

MRP w.e.f. 10.07.2023

Control & Signalling Devices 22.5 Ø









PLASTIC SERIES









MUSHROOM HEAD ACTUATORS

	TYPE	COLOUR	ORDERING CODE	PRICE IN Rs.
	Latching Trigger Ø 40mm			
		Black	P2AMLT2	215.00
		Red	P2AMLT4	215.00
	Latching Trigger with key Ø 40mm			
		Black	P2AMLTKB2	350.00
		Red	P2AMLTKB4	350.00
	Push-Pull Trigger with mechanical Indicator Ø 40 mm	Red	P2AMPPT4	250.00
	Latching Ø 60mm			
		Black	P2AMLJ2	185.00
		Red	P2AMLJ4	185.00
	Push-Pull Ø 60mm			
		Black	P2AMPPJ2	185.00
		Red	P2AMPPJ4	185.00
	Momentary Ø 60mm			
		Black	P2AMJ2	145.00
		Green	P2AMJ3	145.00
		Red	P2AMJ4	145.00
		Blue	P2AMJ6	145.00
	Yellow	P2AMJ8	145.00	

MRP w.e.f. 10.07.2023

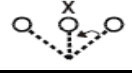

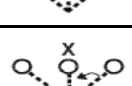
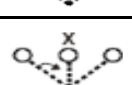
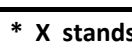

Control & Signalling Devices 22.5 Ø

PLASTIC SERIES					
SELECTOR ACTUATORS					
	TYPE		COLOUR	ORDERING CODE	PRICE IN Rs.
	2 position LATCHING		Black	P2AS2-2P	196.00
	With ext. knob			P2AS2E-2P	196.00
	MOMENTARY			P2AS2-2PSR	196.00
	With ext. knob			P2AS2E-2PSR	196.00
	3 position STAY PUT		Black	P2AS2-3P	196.00
	With ext. knob			P2AS2E-3P	196.00
	MOMENTARY on both sides			P2AS2-3PSR	215.00
	With ext. knob			P2AS2E-3PSR	215.00
	MOMENTARY on right			P2AS2-3PSRR	215.00
	With ext. knob			P2AS2E-3PSRR	215.00
	MOMENTARY on left			P2AS2-3PSRL	215.00
	With ext. knob			P2AS2E-3PSRL	215.00

PLASTIC SERIES						
KEY SELECTOR ACTUATORS						
	TYPE		COLOUR	ORDERING CODE	PRICE IN Rs.	
	2 POSITION Stayput		Black	P2AK2-2PB	275.00	
					P2AK2-2PO	275.00
					P2AK2-2PI	275.00
		Spring Return		P2AK2-2POSR	275.00	
	3 POSITION Stayput		Black	P2AK2-3PA	290.00	
					P2AK2-3PO	290.00
					P2AK2-3PB	290.00
					P2AK2-3PC	290.00
		Spring Return			P2AK2-3PSR	290.00
		Right to Centre			P2AK2-3PSRR	290.00
		Left to Centre			P2AK2-3PSRL	290.00
	* X stands for position in which key is removable					

MRP w.e.f. 10.07.2023

Control & Signalling Devices 22.5 Ø





PLASTIC SERIES				
TWIN ACTUATORS				
	TYPE	COLOUR	ORDERING CODE	PRICE IN Rs.
	Double Flush w/o IO Mark	Green	P2ATF3F4	130.00
		Red		
		Yellow	P2ATF8F2	130.00
		Black		
	Double Flush with IO Mark	Green	P2ATF3F4(IO)	130.00
		Red		
		Yellow	P2ATF8F2(IO)	130.00
		Black		
	1 Flush 1 Projecting w/o IO Mark	Green	P2ATF3P4	130.00
		Red		
		Yellow	P2ATF8P2	130.00
		Black		
	1 Flush 1 Projecting with IO Mark	Green	P2ATF3P4(IO)	130.00
		Red		
		Yellow	P2ATF8P2(IO)	130.00
		Black		

MRP w.e.f. 10.07.2023

Control & Signalling Devices 22.5 Ø

PLASTIC SERIES

ILLUMINATED MOMENTARY ACTUATORS WITH BULB

	TYPE	COLOUR	ORDERING CODE	PRICE IN Rs. WITH BIULB
	Illuminated Flush, Momentary			
	Filament Bulb 6V to 130V AC/DC	White	P2ALF1	175.00
		Green	P2ALF3	175.00
		Red	P2ALF4	175.00
		Amber	P2ALF5	175.00
		Blue	P2ALF6	175.00
		Clear	P2ALF7	175.00
		Yellow	P2ALF8	175.00
Direct Connection	Please mention the voltage required after the ordering code			
	Filament Bulb 24V, 48V,110V, 230 V AC/DC	White	P2ALRF1	190.00
		Green	P2ALRF3	190.00
		Red	P2ALRF4	190.00
		Amber	P2ALRF5	190.00
		Blue	P2ALRF6	190.00
		Clear	P2ALRF7	190.00
		Yellow	P2ALRF8	190.00
Connection with Resistor	Please mention the voltage required after the ordering code			
	Illuminated Projecting, Momentary			
	Filament Bulb 6V to 130V AC/DC	White	P2ALP1	175.00
		Green	P2ALP3	175.00
		Red	P2ALP4	175.00
		Amber	P2ALP5	175.00
		Blue	P2ALP6	175.00
		Clear	P2ALP7	175.00
		Yellow	P2ALP8	175.00
Direct Connection	Please mention the voltage required after the ordering code			
	Filament Bulb 24V, 48V,110V, 230 V AC/DC	White	P2ALRP1	190.00
		Green	P2ALRP3	190.00
		Red	P2ALRP4	190.00
		Amber	P2ALRP5	190.00
		Blue	P2ALRP6	190.00
		Clear	P2ALRP7	190.00
		Yellow	P2ALRP8	190.00
Connection with Resistor	Please mention the voltage required after the ordering code			









PLASTIC SERIES					
ILLUMINATED ACTUATORS WITH INTEGRAL LED / LED BULB					
	TYPE	COLOUR	ORDERING CODE	PRICE IN Rs. INTEGRAL LED	PRICE IN Rs. WITH LED BULB
	Illuminated Flush actuator, Momentary				
	Integral LED 6V, 12V, 24V, 48V AC/DC, 110VAC, 110VDC, 230VAC, 220VDC	White LED / White Lens	P2ALRF1L(S)	375.00	
		Green LED / Green Lens	P2ALRF3L	235.00	
		Red LED / Red Lens	P2ALRF4L	235.00	
		Amber LED / Amber Lens	P2ALRF5L	235.00	
		Blue LED / Blue Lens	P2ALRF6L	485.00	
		White LED / Clear Lens	P2ALRF7L(S)	375.00	
	Yellow LED / Yellow Lens	P2ALRF8L	235.00		
Integral LED	Please mention the voltage required after the ordering code				
	LED Bulb, BA9S type 24V AC/DC, 110VAC, 110VDC, 230VAC, 220VDC	White LED Bulb / White Lens	P2ALF1LB(S)		460.00
		Green LED Bulb / Green Lens	P2ALF3LB		245.00
		Red LED Bulb / Red Lens	P2ALF4LB		245.00
		Amber LED Bulb / Amber Lens	P2ALF5LB		245.00
		Blue LED Bulb / Blue Lens	P2ALF6LB		485.00
		White LED Bulb / Clear Lens	P2ALF7LB(S)		460.00
		Yellow LED Bulb / Yellow Lens	P2ALF8LB		245.00
LED Bulb	Please mention the voltage required after the ordering code				
	Illuminated Projecting Actuator, Momentary				
	Integral LED 6V, 12V, 24V, 48V AC/DC, 110VAC, 110VDC, 230VAC, 220VDC	White LED / White Lens	P2ALRP1L(S)	375.00	
		Green LED / Green Lens	P2ALRP3L	235.00	
		Red LED / Red Lens	P2ALRP4L	235.00	
		Amber LED / Amber Lens	P2ALRP5L	235.00	
		Blue LED / Blue Lens	P2ALRP6L	485.00	
		White LED / Clear Lens	P2ALRP7L(S)	375.00	
	Yellow LED / Yellow Lens	P2ALRP8L	235.00		
Integral LED	Please mention the voltage required after the ordering code				
	LED Bulb, BA9S type 24V AC/DC, 110VAC, 110VDC, 230VAC, 220VDC	White LED Bulb / White Lens	P2ALP1LB(S)		460.00
		Green LED Bulb / Green Lens	P2ALP3LB		245.00
		Red LED Bulb / Red Lens	P2ALP4LB		245.00
		Amber LED Bulb / Amber Lens	P2ALP5LB		245.00
		Blue LED Bulb / Blue Lens	P2ALP6LB		485.00
		White LED Bulb / Clear Lens	P2ALP7LB(S)		460.00
		Yellow LED Bulb / Yellow Lens	P2ALP8LB		245.00
LED Bulb	Please mention the voltage required after the ordering code				









MRP w.e.f. 10.07.2023











Control & Signalling Devices 22.5 Ø

PLASTIC SERIES

ILLUMINATED SELECTOR WITH FILAMENT BULB











	TYPE	COLOUR	ORDERING CODE	PRICE IN Rs. WITH BULB
	2 Position Stayput			
	Filament bulb 6V to 130V AC/DC 	White	P2ASL1-2P	325.00
		Green	P2ASL3-2P	325.00
		Red	P2ASL4-2P	325.00
		Amber	P2ASL5-2P	325.00
		Blue	P2ASL6-2P	325.00
		Clear	P2ASL7-2P	325.00
		Yellow	P2ASL8-2P	325.00
Direct Connection	Please mention the voltage required after the ordering code			
	Filament bulb 24 V,48V,110V, 230V AC/DC 	White	P2ASLR1-2P	340.00
		Green	P2ASLR3-2P	340.00
		Red	P2ASLR4-2P	340.00
		Amber	P2ASLR5-2P	340.00
		Blue	P2ASLR6-2P	340.00
		Clear	P2ASLR7-2P	340.00
		Yellow	P2ASLR8-2P	340.00
	Connection with Resistor	Please mention the voltage required after the ordering code		
	2 Position Momentary			
	Filament bulb 6V to 130V AC/DC 	White	P2ASL1-2PSR	325.00
		Green	P2ASL3-2PSR	325.00
		Red	P2ASL4-2PSR	325.00
		Amber	P2ASL5-2PSR	325.00
		Blue	P2ASL6-2PSR	325.00
		Clear	P2ASL7-2PSR	325.00
		Yellow	P2ASL8-2PSR	325.00
Direct Connection	Please mention the voltage required after the ordering code			
	Filament bulb 24 V,48V,110V, 230V AC/DC 	White	P2ASLR1-2PSR	340.00
		Green	P2ASLR3-2PSR	340.00
		Red	P2ASLR4-2PSR	340.00
		Amber	P2ASLR5-2PSR	340.00
		Blue	P2ASLR6-2PSR	340.00
		Clear	P2ASLR7-2PSR	340.00
		Yellow	P2ASLR8-2PSR	340.00
	Connection with Resistor	Please mention the voltage required after the ordering code		

PLASTIC SERIES					
ILLUMINATED SELECTOR ACTUATOR WITH LED					
	TYPE	COLOUR	ORDERING CODE	PRICE IN Rs. INTEGRAL LED	PRICE IN Rs. WITH LED BULB
	2 Position Stayput				
	Integral LED 6V, 12V, 24V, 48V AC/DC, 110VAC, 110VDC, 230VAC, 220VDC 	White LED / White Lens	P2ASLR1L(S)-2P	525.00	
		Green LED / Green Lens	P2ASLR3L-2P	385.00	
		Red LED / Red Lens	P2ASLR4L-2P	385.00	
		Amber LED / Amber Lens	P2ASLR5L-2P	385.00	
		Blue LED / Blue Lens	P2ASLR6L-2P	625.00	
		White LED / Clear Lens	P2ASLR7L(S)-2P	525.00	
		Yellow LED / Yellow Lens	P2ASLR8L-2P	385.00	
Integral LED	Please mention the voltage required after the ordering code				
	LED Bulb, BA9S type				
	24V AC/DC, 110VAC, 110VDC, 230VAC, 220VDC 	White LED Bulb / White Lens	P2ASL1LB(S)-2P		625.00
		Green LED Bulb / Green Lens	P2ASL3LB-2P		395.00
		Red LED Bulb / Red Lens	P2ASL4LB-2P		395.00
		Amber LED Bulb / Amber Lens	P2ASL5LB-2P		395.00
		Blue LED Bulb / Blue Lens	P2ASL6LB-2P		655.00
		White LED Bulb / Clear Lens	P2ASL7LB(S)-2P		625.00
		Yellow LED Bulb / Yellow Lens	P2ASL8LB-2P		395.00
LED Bulb	Please mention the voltage required after the ordering code				
	2 Position Momentary				
	Integral LED 6V, 12V, 24V, 48V AC/DC, 110VAC, 110VDC, 230VAC, 220VDC 	White LED / White Lens	P2ASLR1L(S)-2PSR	525.00	
		Green LED / Green Lens	P2ASLR3L-2PSR	385.00	
		Red LED / Red Lens	P2ASLR4L-2PSR	385.00	
		Amber LED / Amber Lens	P2ASLR5L-2PSR	385.00	
		Blue LED / Blue Lens	P2ASLR6L-2PSR	625.00	
		White LED / Clear Lens	P2ASLR7L(S)-2PSR	525.00	
		Yellow LED / Yellow Lens	P2ASLR8L-2PSR	385.00	
Integral LED	Please mention the voltage required after the ordering code				
	LED Bulb, BA9S type				
	24V AC/DC, 110VAC, 110VDC, 230VAC, 220VDC 	White LED Bulb / White Lens	P2ASL1LB(S)-2PSR		625.00
		Green LED Bulb / Green Lens	P2ASL3LB-2PSR		395.00
		Red LED Bulb / Red Lens	P2ASL4LB-2PSR		395.00
		Amber LED Bulb / Amber Lens	P2ASL5LB-2PSR		395.00
		Blue LED Bulb / Blue Lens	P2ASL6LB-2PSR		655.00
		White LED Bulb / Clear Lens	P2ASL7LB(S)-2PSR		625.00
		Yellow LED Bulb / Yellow Lens	P2ASL8LB-2PSR		395.00
LED Bulb	Please mention the voltage required after the ordering code				

PLASTIC SERIES					
ILLUMINATED SELECTOR WITH FILAMENT BULB					
	TYPE	COLOUR	ORDERING CODE	PRICE IN Rs. WITH BULB	
	3 Position Illuminated Selector Actuator				
	Stayput Filament bulb 6V to 130V AC/DC 	White	P2ASL1-3P	340.00	
		Green	P2ASL3-3P	340.00	
		Red	P2ASL4-3P	340.00	
		Amber	P2ASL5-3P	340.00	
		Blue	P2ASL6-3P	340.00	
		Clear	P2ASL7-3P	340.00	
		Yellow	P2ASL8-3P	340.00	
		Please mention the voltage required after the ordering code			
	Momentary Filament bulb 6V to 130V AC/DC 	White	P2ASL1-3PSR	350.00	
		Green	P2ASL3-3PSR	350.00	
		Red	P2ASL4-3PSR	350.00	
		Amber	P2ASL5-3PSR	350.00	
		Blue	P2ASL6-3PSR	350.00	
		Clear	P2ASL7-3PSR	350.00	
		Yellow	P2ASL8-3PSR	350.00	
		Please mention the voltage required after the ordering code			
	Stayput / Momentary Filament bulb 6V to 130V AC/DC 	White	P2ASL1-3PSRL	350.00	
		Green	P2ASL3-3PSRL	350.00	
		Red	P2ASL4-3PSRL	350.00	
		Amber	P2ASL5-3PSRL	350.00	
		Blue	P2ASL6-3PSRL	350.00	
		Clear	P2ASL7-3PSRL	350.00	
		Yellow	P2ASL8-3PSRL	350.00	
Please mention the voltage required after the ordering code					
Stayput / Momentary Filament bulb 6V to 130V AC/DC 	White	P2ASL1-3PSRR	350.00		
	Green	P2ASL3-3PSRR	350.00		
	Red	P2ASL4-3PSRR	350.00		
	Amber	P2ASL5-3PSRR	350.00		
	Blue	P2ASL6-3PSRR	350.00		
	Clear	P2ASL7-3PSRR	350.00		
	Yellow	P2ASL8-3PSRR	350.00		
	Please mention the voltage required after the ordering code				
Direct Connection	Please mention the voltage required after the ordering code				
	Stayput Filament Bulb 24V,48V,130V, 230V AC/DC 	White	P2ASLR1-3P	355.00	
		Green	P2ASLR3-3P	355.00	
		Red	P2ASLR4-3P	355.00	
		Amber	P2ASLR5-3P	355.00	
		Blue	P2ASLR6-3P	355.00	
		Clear	P2ASLR7-3P	355.00	
		Yellow	P2ASLR8-3P	355.00	
		Please mention the voltage required after the ordering code			
	Momentary Filament Bulb 24V,48V,130V, 230V AC/DC 	White	P2ASLR1-3PSR	370.00	
		Green	P2ASLR3-3PSR	370.00	
		Red	P2ASLR4-3PSR	370.00	
		Amber	P2ASLR5-3PSR	370.00	
		Blue	P2ASLR6-3PSR	370.00	
		Clear	P2ASLR7-3PSR	370.00	
		Yellow	P2ASLR8-3PSR	370.00	
		Please mention the voltage required after the ordering code			
	Stayput / Momentary Filament Bulb 24V,48V,130V, 230V AC/DC 	White	P2ASLR1-3PSRL	370.00	
		Green	P2ASLR3-3PSRL	370.00	
		Red	P2ASLR4-3PSRL	370.00	
		Amber	P2ASLR5-3PSRL	370.00	
		Blue	P2ASLR6-3PSRL	370.00	
		Clear	P2ASLR7-3PSRL	370.00	
		Yellow	P2ASLR8-3PSRL	370.00	
		Please mention the voltage required after the ordering code			
Stayput / Momentary Filament Bulb 24V,48V,130V, 230V AC/DC 	White	P2ASLR1-3PSRR	370.00		
	Green	P2ASLR3-3PSRR	370.00		
	Red	P2ASLR4-3PSRR	370.00		
	Amber	P2ASLR5-3PSRR	370.00		
	Blue	P2ASLR6-3PSRR	370.00		
	Clear	P2ASLR7-3PSRR	370.00		
	Yellow	P2ASLR8-3PSRR	370.00		
	Please mention the voltage required after the ordering code				
Connection with Resistor	Please mention the voltage required after the ordering code				

PLASTIC SERIES

ILLUMINATED SELECTOR WITH LED/LED BULB





	TYPE	COLOUR	ORDERING CODE	PRICE IN Rs. INTEGRAL LED	PRICE IN Rs. WITH LED BULB	
	3 Position Illuminated Selector Actuator					
	Stayput	White LED / White Lens	P2ASLR1L(S)-3P	545.00		
	Integral LED	Green LED / Green Lens	P2ASLR3L-3P	405.00		
	6V, 12V, 24V, 48V AC/DC	Red LED / Red Lens	P2ASLR4L-3P	405.00		
	110VAC, 110VDC,	Amber LED / Amber Lens	P2ASLR5L-3P	405.00		
	230VAC, 220VDC	Blue LED / Blue Lens	P2ASLR6L-3P	645.00		
		White LED / Clear Lens	P2ASLR7L(S)-3P	545.00		
		Yellow LED / Yellow Lens	P2ASLR8L-3P	405.00		
	Please mention the voltage required after the ordering code					
	Momentary	White LED / White Lens	P2ASLR1L(S)-3PSR	550.00		
	Integral LED	Green LED / Green Lens	P2ASLR3L-3PSR	420.00		
	6V, 12V, 24V, 48V AC/DC	Red LED / Red Lens	P2ASLR4L-3PSR	420.00		
	110VAC, 110VDC,	Amber LED / Amber Lens	P2ASLR5L-3PSR	420.00		
	230VAC, 220VDC	Blue LED / Blue Lens	P2ASLR6L-3PSR	650.00		
		White LED / Clear Lens	P2ASLR7L(S)-3PSR	550.00		
		Yellow LED / Yellow Lens	P2ASLR8L-3PSR	420.00		
	Please mention the voltage required after the ordering code					
	Stayput / Momentary	White LED / White Lens	P2ASLR1L(S)-3PSRL	550.00		
	Integral LED	Green LED / Green Lens	P2ASLR3L-3PSRL	420.00		
	6V, 12V, 24V, 48V AC/DC	Red LED / Red Lens	P2ASLR4L-3PSRL	420.00		
	110VAC, 110VDC,	Amber LED / Amber Lens	P2ASLR5L-3PSRL	420.00		
	230VAC, 220VDC	Blue LED / Blue Lens	P2ASLR6L-3PSRL	650.00		
		White LED / Clear Lens	P2ASLR7L(S)-3PSRL	550.00		
		Yellow LED / Yellow Lens	P2ASLR8L-3PSRL	420.00		
	Please mention the voltage required after the ordering code					
	Stayput / Momentary	White LED / White Lens	P2ASLR1L(S)-3PSRR	550.00		
	Integral LED	Green LED / Green Lens	P2ASLR3L-3PSRR	420.00		
	6V, 12V, 24V, 48V AC/DC	Red LED / Red Lens	P2ASLR4L-3PSRR	420.00		
110VAC, 110VDC,	Amber LED / Amber Lens	P2ASLR5L-3PSRR	420.00			
230VAC, 220VDC	Blue LED / Blue Lens	P2ASLR6L-3PSRR	650.00			
	White LED / Clear Lens	P2ASLR7L(S)-3PSRR	550.00			
	Yellow LED / Yellow Lens	P2ASLR8L-3PSRR	420.00			
Please mention the voltage required after the ordering code						
Integral LED	Please mention the voltage required after the ordering code					
	Stayput	White LED Bulb / White Lens	P2ASL1LB(S)-3P		645.00	
	LED Bulb, BA9S type	Green LED Bulb / Green Lens	P2ASL3LB-3P		420.00	
	24V AC/DC,	Red LED Bulb / Red Lens	P2ASL4LB-3P		420.00	
	110VAC, 110VDC	Amber LED Bulb / Amber Lens	P2ASL5LB-3P		420.00	
	230VAC, 220VDC	Blue LED Bulb / Blue Lens	P2ASL6LB-3P		670.00	
		White LED Bulb / Clear Lens	P2ASL7LB(S)-3P		645.00	
		Yellow LED Bulb / Yellow Lens	P2ASL8LB-3P		420.00	
	Please mention the voltage required after the ordering code					
	Momentary	White LED Bulb / White Lens	P2ASL1LB(S)-3PSR		655.00	
	LED Bulb, BA9S type	Green LED Bulb / Green Lens	P2ASL3LB-3PSR		425.00	
	24V AC/DC,	Red LED Bulb / Red Lens	P2ASL4LB-3PSR		425.00	
	110VAC, 110VDC	Amber LED Bulb / Amber Lens	P2ASL5LB-3PSR		425.00	
	230VAC, 220VDC	Blue LED Bulb / Blue Lens	P2ASL6LB-3PSR		680.00	
		White LED Bulb / Clear Lens	P2ASL7LB(S)-3PSR		655.00	
		Yellow LED Bulb / Yellow Lens	P2ASL8LB-3PSR		425.00	
	Please mention the voltage required after the ordering code					
	Stayput / Momentary	White LED Bulb / White Lens	P2ASL1LB(S)-3PSRL		655.00	
	LED Bulb, BA9S type	Green LED Bulb / Green Lens	P2ASL3LB-3PSRL		425.00	
	24V AC/DC,	Red LED Bulb / Red Lens	P2ASL4LB-3PSRL		425.00	
	110VAC, 110VDC	Amber LED Bulb / Amber Lens	P2ASL5LB-3PSRL		425.00	
	230VAC, 220VDC	Blue LED Bulb / Blue Lens	P2ASL6LB-3PSRL		680.00	
		White LED Bulb / Clear Lens	P2ASL7LB(S)-3PSRL		655.00	
		Yellow LED Bulb / Yellow Lens	P2ASL8LB-3PSRL		425.00	
	Please mention the voltage required after the ordering code					
	Stayput / Momentary	White LED Bulb / White Lens	P2ASL1LB(S)-3PSRR		655.00	
	LED Bulb, BA9S type	Green LED Bulb / Green Lens	P2ASL3LB-3PSRR		425.00	
	24V AC/DC,	Red LED Bulb / Red Lens	P2ASL4LB-3PSRR		425.00	
	110VAC, 110VDC	Amber LED Bulb / Amber Lens	P2ASL5LB-3PSRR		425.00	
230VAC, 220VDC	Blue LED Bulb / Blue Lens	P2ASL6LB-3PSRR		680.00		
	White LED Bulb / Clear Lens	P2ASL7LB(S)-3PSRR		655.00		
	Yellow LED Bulb / Yellow Lens	P2ASL8LB-3PSRR		425.00		
Please mention the voltage required after the ordering code						
LED Bulb	Please mention the voltage required after the ordering code					

MRP w.e.f. 10.07.2023

Control & Signalling Devices 22.5 Ø

PLASTIC SERIES





TWIN ILLUMINATED ACTUATORS WITH FILAMENT BULB

	TYPE	COLOUR	ORDERING CODE	PRICE IN Rs. WITH BULB
	Twin Illuminated 1 Flush, 1 Projecting (IO) Mark			
	Filament bulb 6V to 130V AC/DC	Red	P2ATL5F3P4 (IO)	255.00
		Green		
		Amber Lens		
Direct Connection	Please mention the voltage required after the ordering code			
	Filament bulb 24 V,48V,110V, 230V AC/DC	Red	P2ATLR5F3P4 (IO)	270.00
		Green		
		Amber Lens		
	Connection with Resistor	Please mention the voltage required after the ordering code		
	Twin Illuminated Double Flush, (IO) Mark			
	Filament bulb 6V to 130V AC/DC	Red	P2ATL5 F3F4 (IO)	255.00
		Green		
		Amber Lens		
Direct Connection	Please mention the voltage required after the ordering code			
	Filament bulb 24 V,48V,110V, 230V AC/DC	Red	P2ATLR5 F3F4 (IO)	270.00
		Green		
		Amber Lens		
	Connection with Resistor	Please mention the voltage required after the ordering code		

MRP w.e.f. 10.07.2023

Control & Signalling Devices 22.5 Ø

PLASTIC SERIES

TWIN ILLUMINATED ACTUATORS WITH LED					
	TYPE	COLOUR	ORDERING CODE	PRICE IN Rs. INTEGRAL LED	PRICE IN Rs. WITH LED BULB
	Twin Illuminated 1 Flush, 1 Projecting, (IO) Mark				
	Integral LED 6V, 12V, 24V, 48V AC/DC, 110VAC, 110VDC, 230VAC, 220VDC	Green	P2ATLR5LF3P4 (IO)	310.00	
		Red			
		Amber lens			
Integral LED	Please mention the voltage required after the ordering code				
	LED Bulb,BA9S type 24V AC/DC, 110VAC, 110VDC, 230VAC, 220VDC	Green	P2ATL5LBF3P4 (IO)		330.00
		Red			
		Amber lens			
	LED Bulb	Please mention the voltage required after the ordering code			
	Twin Illuminated Double Flush, (IO) Mark				
	Integral LED 6V, 12V, 24V, 48V AC/DC, 110VAC, 110VDC, 230VAC, 220VDC	Green	P2ATLR5LF3F4 (IO)	310.00	
		Red			
		Amber lens			
Integral LED	Please mention the voltage required after the ordering code				
	LED Bulb,BA9S type 24V AC/DC, 110VAC, 110VDC, 230VAC, 220VDC	Green	P2ATL5LBF3F4 (IO)		330.00
		Red			
		Amber lens			
	LED Bulb	Please mention the voltage required after the ordering code			

MRP w.e.f. 10.07.2023

Control & Signalling Devices 22.5 Ø

PLASTIC SERIES

PILOT LIGHTS WITH FILAMENT BULB

	TYPE	COLOUR	ORDERING CODE	PRICE IN Rs. WITH BULB
	Pilot Light			
	Filament Bulb 6V to 130V AC/DC	White	P2PLB1	145.00
		Green	P2PLB3	145.00
		Red	P2PLB4	145.00
		Amber	P2PLB5	145.00
		Blue	P2PLB6	145.00
		Clear	P2PLB7	145.00
		Yellow	P2PLB8	145.00
Direct Connection	Please mention the voltage required after the ordering code			
	Filament Bulb 24V,48V,110V, 230V AC/DC	White	P2PLBR1	155.00
		Green	P2PLBR3	155.00
		Red	P2PLBR4	155.00
		Amber	P2PLBR5	155.00
		Blue	P2PLBR6	155.00
		Clear	P2PLBR7	155.00
		Yellow	P2PLBR8	155.00
Connection with Resistor	Please mention the voltage required after the ordering code			
	Filament bulb 230 V AC	White	P2PLBR1240AC	155.00
		Green	P2PLBR3240AC	155.00
		Red	P2PLBR4240AC	155.00
		Amber	P2PLBR5240AC	155.00
		Blue	P2PLBR6240AC	155.00
		Clear	P2PLBR7240AC	155.00
		Yellow	P2PLBR8240AC	155.00
Connection with Resistor + Diode	Please mention the voltage required after the ordering code			
	Filament bulb			
	Primary volt. Sec. Volt.	White	P2PLBT1 XXX / YY	400.00
	110VAC 06	Green	P2PLBT3 XXX / YY	400.00
	110VAC 12	Red	P2PLBT4 XXX / YY	400.00
	110VAC 24	Amber	P2PLBT5 XXX / YY	400.00
	Primary volt. Sec. Volt.	Blue	P2PLBT6 XXX / YY	400.00
	240VAC 06	Clear	P2PLBT7 XXX / YY	400.00
	240VAC 12	Yellow	P2PLBT8 XXX / YY	400.00
	240VAC 24			
	Connection with Transformer	XXX - Primary Voltage YY - Secondary Voltage		



MRP w.e.f. 10.07.2023

Control & Signalling Devices 22.5 Ø

PLASTIC SERIES

PILOT LIGHTS

	TYPE	COLOUR	ORDERING CODE	PRICE IN Rs. INTEGRAL LED
	Integral LED 6V, 12V, 24V, 48V AC/DC, 110VAC, 110VDC, 230VAC, 220VDC	White LED / White Lens	P2PLBR1L(S)	365.00
		Green LED / Green Lens	P2PLBR3L	200.00
		Red LED / Red Lens	P2PLBR4L	200.00
		Amber LED / Amber Lens	P2PLBR5L	200.00
		Blue LED / Blue Lens	P2PLBR6L	500.00
		White LED / Clear Lens	P2PLBR7L(S)	365.00
		Yellow LED / Yellow Lens	P2PLBR8L	200.00
		Integral LED	Please mention the voltage required after the ordering code	
	Integral LED, Flasher 24V, 110V, 230V AC	White LED Bulb / White Lens	P2PLBR1LF(S)	365.00
		Green LED Bulb / Green Lens	P2PLBR3LF	200.00
		Red LED Bulb / Red Lens	P2PLBR4LF	200.00
		Amber LED Bulb / Amber Lens	P2PLBR5LF	200.00
		Blue LED Bulb / Blue Lens	P2PLBR6LF	500.00
		White LED Bulb / Clear Lens	P2PLBR7LF(S)	365.00
		Yellow LED Bulb / Yellow Lens	P2PLBR8LF	200.00
Integral LED	Please mention the voltage required after the ordering code			
	Integral LED, Universal 24V upto 240V AC / DC	White LED / White Lens	P2PLBR1LU(S)	515.00
		Green LED / Green Lens	P2PLBR3LU	365.00
		Red LED / Red Lens	P2PLBR4LU	365.00
		Amber LED / Amber Lens	P2PLBR5LU	365.00
		Blue LED / Blue Lens	P2PLBR6LU	615.00
		White LED / Clear Lens	P2PLBR7LU(S)	515.00
		Yellow LED / Yellow Lens	P2PLBR8LU	365.00
Integral LED, Universal	Please mention the voltage required after the ordering code			
	Integral LED 415VAC	White LED / White Lens	P2PLBR1L(S)	425.00
		Green LED / Green Lens	P2PLBR3L	255.00
		Red LED / Red Lens	P2PLBR4L	255.00
		Amber LED / Amber Lens	P2PLBR5L	255.00
		Blue LED / Blue Lens	P2PLBR6L	550.00
		White LED / Clear Lens	P2PLBR7L(S)	425.00
		Yellow LED / Yellow Lens	P2PLBR8L	255.00
Integral LED, 415VAC	Please mention the voltage required after the ordering code			
	Integral LED, Test Lamp 24V AC/DC, 110VAC, 110VDC, 230VAC, 220VDC	White LED / White Lens	P2PLBR1L(S)**TL	500.00
		Green LED / Green Lens	P2PLBR3L**TL	300.00
		Red LED / Red Lens	P2PLBR4L**TL	300.00
		Amber LED / Amber Lens	P2PLBR5L**TL	300.00
		Blue LED / Blue Lens	P2PLBR6L**TL	645.00
		White LED / Clear Lens	P2PLBR7L(S)**TL	500.00
		Yellow LED / Yellow Lens	P2PLBR8L**TL	300.00
Integral LED, Test Lamp	** Please mention the voltage required after the ordering code			

PLASTIC SERIES					
PILOT LIGHTS					
	TYPE	COLOUR	ORDERING CODE	PRICE IN Rs. WITH LED BULB	
	Pilot Light with LED Bulb				
	LED Bulb, BA9S type 24V AC/DC, 110VAC, 110VDC, 230VAC, 220VDC	White LED Bulb / White Lens	P2PLB1LB(S)	425.00	
		Green LED Bulb / Green Lens	P2PLB3LB	215.00	
		Red LED Bulb / Red Lens	P2PLB4LB	215.00	
		Amber LED Bulb / Amber Lens	P2PLB5LB	215.00	
		Blue LED Bulb / Blue Lens	P2PLB6LB	450.00	
		White LED Bulb / Clear Lens	P2PLB7LB(S)	425.00	
	Yellow LED Bulb / Yellow Lens	P2PLB8LB	215.00		
LED Bulb	Please mention the voltage required after the ordering code				
	LED Bulb				
	Pri. Volt.	Sec Volt.	White LED Bulb / White Lens	P2PLBT1LB(S) XXX / YY	710.00
	110VAC	06	Green LED Bulb / Green Lens	P2PLBT3LB XXX / YY	505.00
	110VAC	12	Red LED Bulb / Red Lens	P2PLBT4LB XXX / YY	505.00
	110VAC	24	Amber LED Bulb / Amber Lens	P2PLBT5LB XXX / YY	505.00
	Pri. Volt.	Sec Volt.	Blue LED Bulb / Blue Lens	P2PLBT6LB XXX / YY	740.00
	240VAC	06	White LED Bulb / Clear Lens	P2PLBT7LB(S) XXX / YY	710.00
	240VAC	12	Yellow LED Bulb / Yellow Lens	P2PLBT8LB XXX / YY	505.00
	240VAC	24			
Connection with Transformer	XXX - Primary Voltage				
	YY - Secondary Voltage				

MRP w.e.f. 10.07.2023

Control & Signalling Devices 22.5 Ø

PLASTIC SERIES

LED PILOT LIGHTS ECONOMY SERIES

	TYPE	COLOUR	ORDERING CODE	PRICE IN Rs. WITH LED BULB
	Integral LED 6V, 12V, 24V, 48V AC/DC, 110VAC, 110VDC, 230VAC, 220VDC	White LED / White Lens	3PLBR1L(S)	325.00
		Green LED / Green Lens	3PLBR3L	160.00
		Red LED / Red Lens	3PLBR4L	160.00
		Amber LED / Amber Lens	3PLBR5L	160.00
		Blue LED / Blue Lens	3PLBR6L	445.00
		White LED / Clear Lens	3PLBR7L(S)	325.00
		Yellow LED / Yellow Lens	3PLBR8L	160.00
		Please mention the voltage required after the ordering code		
	Integral LED, 24V upto 240V AC / DC	White LED / White Lens	3PLBR1LU(S)	415.00
		Green LED / Green Lens	3PLBR3LU	265.00
		Red LED / Red Lens	3PLBR4LU	265.00
		Amber LED / Amber Lens	3PLBR5LU	265.00
		Blue LED / Blue Lens	3PLBR6LU	550.00
		White LED / Clear Lens	3PLBR7LU(S)	415.00
		Yellow LED / Yellow Lens	3PLBR8LU	265.00
Please mention the voltage required after the ordering code				
	Integral LED, Dual colour			
	24VAC	Green LED	3PLBR34L	270.00
	110VAC	Red LED		
	230VAC	White Lens		
Please mention the voltage required after the ordering code				
	Integral LED with Buzzer			
	12VAC/DC	Red LED	3PLBR4LBZ	285.00
	24VAC/DC			
	110VAC			
	230VAC			
Please mention the voltage required after the ordering code				
	Integral LED with Test Lamp			
	12VAC/DC	Red LED	3PLBR4LTL	250.00
	24VAC/DC			
	110VAC			
	230VAC			
Please mention the voltage required after the ordering code				

MRP w.e.f. 10.07.2023

Control & Signalling Devices 22.5 Ø

PLASTIC SERIES

CONTACT ELEMENTS

	TYPE	ORDERING CODE	PRICE IN Rs.
	PANEL MOUNTING		
	NORMALLY OPEN (NO) SILVER CONTACT	S1	72.50
	NORMALLY OPEN (NO) SILVER CONTACT (BREAK BEFORE MAKE)	S1S	72.50
	NORMALLY OPEN (NO) SILVER CONTACT (MAKE BEFORE BREAK)	S1E	72.50
	NORMALLY CLOSED (NC) SILVER CONTACT	S2	72.50
	NORMALLY OPEN (NO) GOLD CONTACT	S3	195.00
	NORMALLY CLOSED (NC) GOLD CONTACT	S4	195.00
	BASE MOUNTING		
	NORMALLY OPEN (NO) SILVER CONTACT	S5	72.50
	NORMALLY CLOSED (NC) SILVER CONTACT	S6	72.50
	NORMALLY OPEN (NO) GOLD CONTACT	S7	195.00
	NORMALLY CLOSED (NC) GOLD CONTACT	S8	195.00

Common types of control and signalling devices Ø 22.5 P series

Description	Type of Actuator or Lense Assembly	Colour of Actuator or Lense	Contact Elements NO = S1 NC = S2 or Lamp Holder	Type of complete Control or Signalling Device	
Flush Pushbutton	P2AF3	Green	1NO	P2PSF310	
	P2AF8	Yellow	2NO+1NC	P2PSF821	
Projecting Pushbutton	P2AP2	Black	2NC	P2PSP202	
	P2AP4	Red	3NO+3NC	P2PSP433	
Booted Pushbutton	P2AB3BT7	Green	2NO	P2PSB3BT720	
	P2AB4BT7	Red	2NC	P2PSB4BT702	
Mushroom Pushbutton Spring return	P2AM2	Black	1NO+1NC	P2PSM211	
	P2AM4	Red	1NC	P2PSM401	
Mushroom Pushbutton latching turn to release	P2AML2	Black	1NC	P2PSML201	
	P2AML4	Red	2NO+2NC	P2PSML422	
Mushroom Pushbutton latching, key to release	P2AMLKB4	Red	1NO+1NC	P2PSMLKB411	
Selector Actuator(2 Pos)	P2AS2-2P	Black	1NO	P2PSS210-2P	
Selector Actuator(3 Pos)	P2AS2-3P	Black	1NO+1NC	P2PSS211-3P	
Key Actuator (2 Pos), key removable in both positions	P2AK2-2PB		1NO	P2PSK210-2PB	
Key Actuator (3 Pos), key removable in left & right positions	P2AK2-3PB		1NO+1NC	P2PSK211-3PB	
Twin Pushbutton marked "I O"	P2ATF2-F4-IO	Flush-Black	1 NO	P2PSTF210-F401-IO	
Flush - Flush		Flush-Red	1 NC		
Twin Pushbutton not marked	P2ATF3-P4	Flush-Green	1NO+1NC	P2PSTF311-P411	
Flush - Projecting		Proj-Red	1NO+1NC		
Flush Illuminated Pushbutton with integral LED for 24V DC	P2ALRF3L24DC	Green	1NO+1NC	P2PSLRF3L1124DC	
	P2ALRP4L230AC	Red	1NO+1NC	P2PSLRP4L11230AC	
Twin Luminous Pushbutton marked "I O"	P2ATL3-F2 -F4 IO130	Lense-Green	1 NO + 1 NC	P2PSTL3F211-F401-IO130	
		Flush-Black			
Twin Luminous Pushbutton not marked	P2ATLR5-F3 -P4230	Lense-Amber	1 NO	P2PSTLR5F310-P401 230	
		Flush-Green			
Pilot Light for direct connection upto 130V	P2PLLA3	Green	2LHB130	P2PLB3130	
	P2PLLA4	Red	2LHB130	P2PLB4130	
Pilot Light through resistor and diode for 230 V AC. Bulb:130 V.	P2PLLA5	Amber	2LHBR230 AC	P2PLBR5230AC	
	P2PLLA6	Blue	2LHBR230 AC	P2PLBR6230AC	
Pilot Light with transformer for 230 V Bulb:24 V.	P2PLLA4	Red	2LHBT230/24	P2PLBT4230/24	
	P2PLLA3	Green	2LHBT230/24	P2PLBT3230/24	
Pilot Light with LED bulb for 110V AC Bulb: 110V	P2PLLA5	Amber	2LHLB110	P2PLB5LB110	
Pilot light economy type with integral LED for 220 DC	-	White	-	3PLBR1L220DC	



GENERAL TERMS AND CONDITIONS

General Terms : Prices are ex-works Mumbai
HSN CODE : 85365010 for all the products of this MRP List
GST : 18%

Prices are subject to revision without notice and ruling at the time of delivery.

This price list supersedes all previous Price Lists.

Warranty Policy : TEKNIC equipment is guaranteed under the following terms:

For a period of 12 months from the date of sale, TEKNIC guarantees that its products are free from defects in material and workmanship, with the exception of consumables rendered unserviceable through normal use. During the said period, TEKNIC will replace or repair all parts acknowledged as defective due to factory workmanship and which have been returned in a timely manner by Buyer to TEKNIC and all costs and duties paid, together with a detailed description of the failure and a certified declaration of the number of hours of operation. Repaired or replaced parts will be redelivered FCA (named place) as per INCOTERMS 2000. This warranty is subject to the provision of correct usage, proper maintenance and does not cover defects arising out of fire, faulty operation, accident, inefficient maintenance and willful or accidental damage.

TEKNIC guarantee applies to all equipment, parts and components stored, installed, protected, maintained and used in accordance with TEKNIC specifications and instructions, and respecting the rules for normal use, without any modification by Buyer.

All other conditions or warranties, whether express or implied, relating to the quality and operation of the equipment are excluded, as well as any liability for loss or damage caused directly or indirectly by the equipment or resulting from its use.

Proof of purchase to be provided to avail warranty.

TEKNIC ELECTRIC (I) PVT. LTD.

Reg.Office : 116, Hammersmith Industrial Estate, Mahim (W), Mumbai – 400016.

Head Office : 703/704/705, Madhava, Bandra Kurla Complex, Bandra (E), Mumbai – 400051. Tel : +91-22-42532500

Works : 65, Marol Co-op. Industrial Estate Ltd., M. Vassanji Road, Andheri (East), Mumbai – 400059. Tel : +91-22-42534500

Email : teknico@teknico.co.in mfg@teknico.co.in Website : www.teknico.co.in



TEKNIC ELECTRIC



Control and Signaling Devices Ø 22.5 Metal Clip on Series

MRP with effect from 10.07.2023

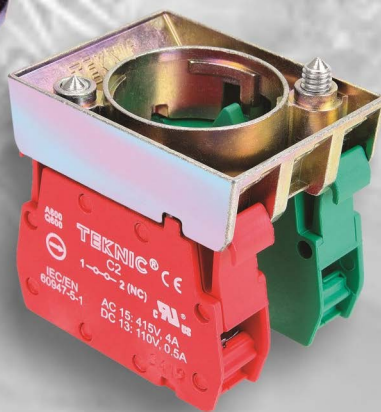

Control and signaling devices Ø22.5 Metallic Clip on series

Salient features

This range of Ø22.5 Metallic Clip on series pushbuttons, selector switches, illuminated switches and pilot lights in engineering plastic construction have been designed to provide the following salient features:

- Economy of space
- Protection against electrical shock
- Robust in materials of construction
- Larger operating surface than Ø30.5 series
- Safe in operation
- Simple to fix-screw driver is all that is required
- Fixing method unaffected by excessive vibration unit does not rotate
- Very good flame resistance
- Aesthetically elegant
- Shrouded terminals
- Resistant to corrosion

Actuators

The circular actuators have metallic bezels and are functionally interchangeable on the different types of contact elements.

Contact elements

The contact elements have double break contacts. The elements are interchangeable and can be stacked without additional hardware. 1 to 6 elements (NO or NC) can be used with non illuminated actuators, whereas 1 to 4 elements (NO or NC) can be used for illuminated actuators. Gold plated NO and NC contact elements for low voltage, low current switching circuits < 25mA are available

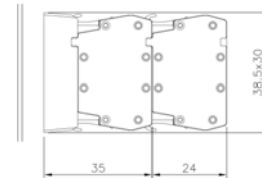

Illuminated pushbuttons and pilot lights

Pilot lights and illuminated switches are suitable for direct connection using bayonet cap led bulb type BA9S as follows:

Supply voltage for direct connection without series resistor.....6V-240V

Bulb.....led type Ba9S with OAL max 28mm

Terminals

Contact elements and pilot lights are designed to have shrouded terminals with combi screws

Fixing

The Ø22.5 4P metallic Clip on series control devices can be fixed in any position on panels of 1 to 5 mm thickness.

We recommend minimum fixing centres of 30mm X 40mm. However, the dimensions and configuration should be decided on the basis of the application.

The actuators, pilot lights bayonet fits & the lense assemblies snap fits on the holding bracket. Details of the assembly shown in the diagram

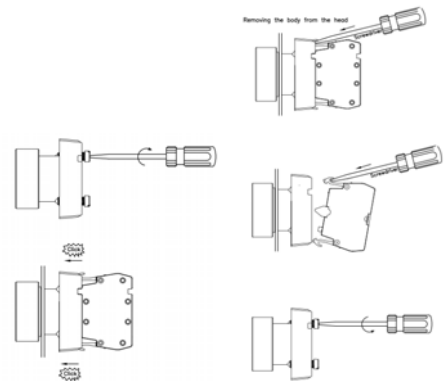
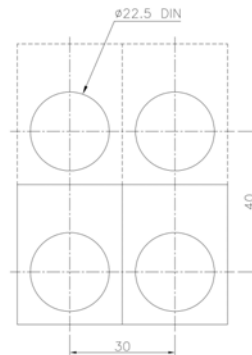

Electrical and mechanical characteristics

Standards conformity	: UL508, EN 60947-5-1
Approvals	: UL508
Degree of protection	: IP65 as per IEC 60529, NEMA 4X, 12 as per UL50
Ambient	: -25°C to +70°C
Operating position	: All positions
Pollution degree	: 3

Contact Block

Rated insulation voltage	: 500V										
Rated thermal current	: 10A										
Contact operation	: Slow break NO or NC										
Make and break capacity	: AC15 4A, 415V AC										
As per IEC 60947-5-1	: DC13 0.5A, 110VDC										
As per UL 508	: A600 Q600										
Terminal Capacity	: Maximum 2X1.5mm ² , Minimum 1X2.5mm ² or minimum 1X0.5mm ²										
Terminal marking	: 1NC 2 for NC & 3NO 4 for NO										
Short circuit protection	: 10A HRC cartridge fuse, rated for resistive loading at 1000A prospective current										
Mechanical life	: Over 1 million operations										
Electrical rating (for 1 million operation cycles at 3600 cycles per hour, load factor 0.5)	: AC15										
	<table border="0" style="display: inline-table;"> <tr> <td>V</td> <td>24</td> <td>120</td> <td>230</td> <td></td> </tr> <tr> <td>A</td> <td>4</td> <td>3</td> <td>2</td> <td></td> </tr> </table>	V	24	120	230		A	4	3	2	
V	24	120	230								
A	4	3	2								
	<table border="0" style="display: inline-table;"> <tr> <td></td> <td></td> <td>DC13</td> </tr> <tr> <td>V</td> <td>24</td> <td>110</td> </tr> <tr> <td>A</td> <td>0.5</td> <td>0.2</td> </tr> </table>			DC13	V	24	110	A	0.5	0.2	
		DC13									
V	24	110									
A	0.5	0.2									
Screw clamp tightening torque	: 0.8Nm (nominal recommended)										

Modules for pilot lights & illuminated switches with LED bulbs (Ba9S cap)

Current consumption (applicable to all colors)	: max 20mA
Terminal capacity	: Maximum 2X1.5mm ² , Minimum 1X2.5mm ² or minimum 1X0.5mm ²
Service life (at nominal voltage and at ambient temperature at 25°C)	: 50,000 hours

MRP w.e.f. 10.07.2023

Control & Signalling Devices 22.5 Ø





CLIP ON METAL SERIES				
MOMENTARY ACTUATORS				
	TYPE	COLOUR	ORDERING CODE	PRICE IN Rs.
	Flush	White	4AF1	80.50
		Black	4AF2	80.50
		Green	4AF3	80.50
		Red	4AF4	80.50
		Blue	4AF6	80.50
		Yellow	4AF8	80.50
	Projecting	White	4AP1	80.50
		Black	4AP2	80.50
		Green	4AP3	80.50
		Red	4AP4	80.50
		Blue	4AP6	80.50
		Yellow	4AP8	80.50
	Flush with arrow marking	White	4AF1BA	105.00
		Black	4AF2WA	105.00
	Flush Relay Reset	White	4AF1RR	110.00
		Black	4AF2RR	110.00
		Green	4AF3RR	110.00
		Red	4AF4RR	110.00
		Blue	4AF6RR	110.00
		Yellow	4AF8RR	110.00
	Recess head	White	4AF1RH	130.00
		Black	4AF2RH	130.00
		Green	4AF3RH	130.00
		Red	4AF4RH	130.00
		Blue	4AF6RH	130.00
		Yellow	4AF8RH	130.00
	Booted	Black	4AB2	150.00
		Green	4AB3	150.00
		Red	4AB4	150.00
		Blue	4AB6	150.00
		Yellow	4AB8	150.00

MRP w.e.f. 10.07.2023

Control & Signalling Devices 22.5 Ø

CLIP ON METAL SERIES

MUSHROOM ACTUATORS

	TYPE	COLOUR	ORDERING CODE	PRICE IN Rs.
	Latching	Black	4AMLS2	175.00
	Head Ø 30mm	Red	4AMLS4	175.00
	Momentary	Black	4AM2	125.00
	Head Ø 40mm	Green	4AM3	125.00
		Red	4AM4	125.00
		Blue	4AM6	125.00
		Yellow	4AM8	125.00
	Latching	Black	4AML2	175.00
	Head Ø 40mm	Red	4AML4	175.00
	Push-Pull	Black	4AMPP2	175.00
	Head Ø 40mm	Red	4AMPP4	175.00
	Latching	Black	4AMLKB2	350.00
	with Key	Red	4AMLKB4	350.00
	Head Ø 40mm			

MRP w.e.f. 10.07.2023

Control & Signalling Devices 22.5 Ø

CLIP ON METAL SERIES

MUSHROOM ACTUATORS









	TYPE	COLOUR	ORDERING CODE	PRICE IN Rs.
				
	Latching Trigger	Black	4AMLT2	260.00
	Head Ø 40mm	Red	4AMLT4	260.00
				
	Latching Trigger with key	Black	4AMLTKB2	440.00
	Head Ø 40mm	Red	4AMLTKB4	440.00
				
	Latching	Black	4AMLJ2	235.00
	Head Ø 60mm	Red	4AMLJ4	235.00
				
	Push-Pull	Black	4AMPPJ2	235.00
	Head Ø 60mm	Red	4AMPPJ4	235.00
		Black	4AMJ2	175.00
	Momentary	Green	4AMJ3	175.00
	Head Ø 60mm	Red	4AMJ4	175.00
		Blue	4AMJ6	175.00
		Yellow	4AMJ8	175.00



MRP w.e.f. 10.07.2023
Control & Signalling Devices 22.5 Ø

CLIP ON METAL SERIES

SELECTOR ACTUATORS









	TYPE		COLOUR	ORDERING CODE	PRICE IN Rs.
	2 position LATCHING		Black	4AS2-2P	242.00
	With extended knob			4AS2E-2P	242.00
	2 position MOMENTARY			4AS2-2PSR	242.00
	With extended knob			4AS2E-2PSR	242.00
	3 position STAY PUT		4AS2-3P	242.00	
	With extended knob		4AS2E-3P	242.00	
	MOMENTARY on both sides		4AS2-3PSR	263.00	
	With extended knob		4AS2E-3PSR	263.00	
	MOMENTARY on right		4AS2-3PSRR	263.00	
	With extended knob		4AS2E-3PSRR	263.00	
	MOMENTARY on left		4AS2-3PSRL	263.00	
	With extended knob		4AS2E-3PSRL	263.00	

MRP w.e.f. 10.07.2023
Control & Signalling Devices 22.5 Ø

CLIP ON METAL SERIES

KEY SELECTOR

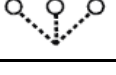

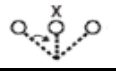
TYPE		COLOUR	ORDERING CODE	PRICE IN Rs.	
2 POSITION Stayput		Black	4AK2-2PB	335.00	
			4AK2-2PO	335.00	
			4AK2-2PI	335.00	
Spring Return			4AK2-2POSR	335.00	
3 POSITION Stayput		Black	4AK2-3PA	355.00	
			4AK2-3PB	355.00	
			4AK2-3PC	355.00	
	Spring Return			4AK2-3PCSR	355.00
	Spring Return right to centre			4AK2-3PCSRR	355.00
	Spring Return left to centre			4AK2-3PCSRL	355.00

* X stands for position in which key is removable





MRP w.e.f. 10.07.2023



Control & Signalling Devices 22.5 Ø

CLIP ON METAL SERIES

TWIN ACTUATORS

	TYPE	COLOUR	ORDERING CODE	PRICE IN Rs.
	Twin Actuator Double Flush, (IO) Mark			
	Flush Button with I mark	Green	4ATF3F4(IO)	160.00
	Flush Button with O mark	Red		
	Twin Actuator Flush/Projecting, (IO) Mark			
	Flush Button with I mark	Green	4ATF3P4(IO)	160.00
	Projecting Button with O mark	Red		

TWIN ILLUMINATED ACTUATORS WITH LED BULB

	TYPE	COLOUR	ORDERING CODE	PRICE IN Rs.
	Twin Illuminated Double Flush, (IO) Mark			
	LED Bulb, BA9S type	Green	4ATL5LBF3F4 (IO)	375.00
	24 V AC/DC,	Red		
	110 VAC, 110 VDC	Amber Lense/Amber LED		
	230 VAC, 220 VDC			
	Please mention the voltage required after the ordering code			
	Twin Illuminated 1 Flush, 1 Projecting, (IO) Mark			
	LED Bulb, BA9S type	Green	4ATL5LBF3P4 (IO)	375.00
	24 V AC/DC,	Red		
	110 VAC, 110 VDC	Amber Lense/Amber LED		
	230 VAC, 220 VDC			
	Please mention the voltage required after the ordering code			



MRP w.e.f. 10.07.2023

Control & Signalling Devices 22.5 Ø

CLIP ON METAL SERIES

ILLUMINATED MOMENTARY ACTUATORS WITH LED BULB

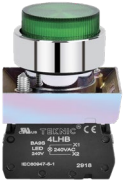
	TYPE	COLOUR	ORDERING CODE	PRICE IN Rs. WITH LED BULB
	Illuminated Flush, Momentary			
	LED Bulb, BA9S type	White LED Bulb / White Lens	4ALF1LB(S)	510.00
	24V AC/DC,	Green LED Bulb / Green Lens	4ALF3LB	280.00
	110VAC, 110VDC	Red LED Bulb / Red Lens	4ALF4LB	280.00
	230VAC, 220VDC	Amber LED Bulb / Amber Lens	4ALF5LB	280.00
		Blue LED Bulb / Blue Lens	4ALF6LB	545.00
		White LED Bulb/ Clear Lens	4ALF7LB(S)	510.00
		Yellow LED Bulb / Yellow Lens	4ALF8LB	280.00
LED Bulb	Please mention the voltage required after the ordering code			
	Illuminated Projecting, Momentary			
		White LED Bulb / White Lens	4ALP1LB(S)	510.00
	LED Bulb, BA9S type	Green LED Bulb / Green Lens	4ALP3LB	280.00
	24V AC/DC,	Red LED Bulb / Red Lens	4ALP4LB	280.00
	110VAC, 110VDC	Amber LED Bulb / Amber Lens	4ALP5LB	280.00
	230VAC, 220VDC	Blue LED Bulb / Blue Lens	4ALP6LB	545.00
		White LED Bulb/ Clear Lens	4ALP7LB(S)	510.00
		Yellow LED Bulb / Yellow Lens	4ALP8LB	280.00
LED Bulb	Please mention the voltage required after the ordering code			





MRP w.e.f. 10.07.2023

Control & Signalling Devices 22.5 Ø

CLIP ON METAL SERIES

ILLUMINATED SELECTOR ACTUATOR WITH LED BULB

	TYPE	COLOUR	ORDERING CODE	PRICE IN Rs. WITH LED BULB
	2 Position illuminated selector actuator			
	LED Bulb BA9S type	White LED Bulb / White Lens	4ASL1LB(S)-2P	705.00
	24V AC/DC,	Green LED Bulb / Green Lens	4ASL3LB-2P	465.00
	110VAC, 110VDC	Red LED Bulb / Red Lens	4ASL4LB-2P	465.00
	230VAC, 220VDC	Amber LED Bulb / Amber Lens	4ASL5LB-2P	465.00
		Blue LED Bulb / Blue Lens	4ASL6LB-2P	730.00
		White LED Bulb / Clear Lens	4ASL7LB(S)-2P	705.00
		Yellow LED Bulb / Yellow Lens	4ASL8LB-2P	465.00
	Please mention the voltage required after the ordering code			
	LED Bulb BA9S type	White LED Bulb / White Lens	4ASL1LB(S)-2PSR	705.00
	24V AC/DC,	Green LED Bulb / Green Lens	4ASL3LB-2PSR	465.00
	110VAC, 110VDC	Red LED Bulb / Red Lens	4ASL4LB-2PSR	465.00
	230VAC, 220VDC	Amber LED Bulb / Amber Lens	4ASL5LB-2PSR	465.00
		Blue LED Bulb / Blue Lens	4ASL6LB-2PSR	730.00
		White LED Bulb / Clear Lens	4ASL7LB(S)-2PSR	705.00
		Yellow LED Bulb / Yellow Lens	4ASL8LB-2PSR	465.00
LED Bulb	Please mention the voltage required after the ordering code			











MRP w.e.f. 10.07.2023

Control & Signalling Devices 22.5 Ø

CLIP ON METAL SERIES



ILLUMINATED SELECTOR WITH LED BULB

	TYPE	COLOUR	ORDERING CODE	PRICE IN Rs. WITH LED BULB	
3 Position Illuminated Selector Actuator					
	Stayput	White LED Bulb / White Lens	4ASL1LB(S)-3P	725.00	
	LED Bulb BA9S type	Green LED Bulb / Green Lens	4ASL3LB-3P	480.00	
	24V AC/DC,	Red LED Bulb / Red Lens	4ASL4LB-3P	480.00	
	110VAC, 110VDC	Amber LED Bulb / Amber Lens	4ASL5LB-3P	480.00	
	230VAC, 220VDC	Blue LED Bulb / Blue Lens	4ASL6LB-3P	755.00	
		White LED Bulb / Clear Lens	4ASL7LB(S)-3P	725.00	
		Yellow LED Bulb / Yellow Lens	4ASL8LB-3P	480.00	
	Please mention the voltage required after the ordering code				
		Momentary	White LED Bulb / White Lens	4ASL1LB(S)-3PSR	735.00
		LED Bulb BA9S type	Green LED Bulb / Green Lens	4ASL3LB-3PSR	495.00
24V AC/DC,		Red LED Bulb / Red Lens	4ASL4LB-3PSR	495.00	
110VAC, 110VDC		Amber LED Bulb / Amber Lens	4ASL5LB-3PSR	495.00	
230VAC, 220VDC		Blue LED Bulb / Blue Lens	4ASL6LB-3PSR	765.00	
		White LED Bulb / Clear Lens	4ASL7LB(S)-3PSR	735.00	
		Yellow LED Bulb / Yellow Lens	4ASL8LB-3PSR	495.00	
Please mention the voltage required after the ordering code					
		Momentary / Stayput	White LED Bulb / White Lens	4ASL1LB(S)-3PSRL	735.00
		LED Bulb BA9S type	Green LED Bulb / Green Lens	4ASL3LB-3PSRL	495.00
	24V AC/DC,	Red LED Bulb / Red Lens	4ASL4LB-3PSRL	495.00	
	110VAC, 110VDC	Amber LED Bulb / Amber Lens	4ASL5LB-3PSRL	495.00	
	230VAC, 220VDC	Blue LED Bulb / Blue Lens	4ASL6LB-3PSRL	765.00	
		White LED Bulb / Clear Lens	4ASL7LB(S)-3PSRL	735.00	
		Yellow LED Bulb / Yellow Lens	4ASL8LB-3PSRL	495.00	
	Please mention the voltage required after the ordering code				
		Momentary / Stayput	White LED Bulb / White Lens	4ASL1LB(S)-3PSRR	735.00
		LED Bulb BA9S type	Green LED Bulb / Green Lens	4ASL3LB-3PSRR	495.00
24V AC/DC,		Red LED Bulb / Red Lens	4ASL4LB-3PSRR	495.00	
110VAC, 110VDC		Amber LED Bulb / Amber Lens	4ASL5LB-3PSRR	495.00	
230VAC, 220VDC		Blue LED Bulb / Blue Lens	4ASL6LB-3PSRR	765.00	
		White LED Bulb / Clear Lens	4ASL7LB(S)-3PSRR	735.00	
		Yellow LED Bulb / Yellow Lens	4ASL8LB-3PSRR	495.00	
Please mention the voltage required after the ordering code					
LED Bulb		Please mention the voltage required after the ordering code			



MRP w.e.f. 10.07.2023

Control & Signalling Devices 22.5 Ø

CLIP ON METAL SERIES				
ILLUMINATED MUSHROOM WITH LED BULB				
	TYPE	COLOUR	ORDERING CODE	PRICE IN Rs. WITH LED BULB
		Illuminated Mushroom, Momentary		
LED Bulb, BA9S type				
24V AC/DC,		Green	4ALM3LB	480.00
110VAC, 110VDC		Red	4ALM4LB	480.00
230VAC, 220VDC				
LED Bulb	Please mention the voltage required after the ordering code			
	Illuminated Mushroom, Push Pull			
	LED Bulb, BA9S type			
	24V AC/DC,	Green	4ALMPP3LB	545.00
	110VAC, 110VDC	Red	4ALMPP4LB	545.00
	230VAC, 220VDC			
LED Bulb	Please mention the voltage required after the ordering code			



MRP w.e.f. 10.07.2023

Control & Signalling Devices 22.5 Ø

CLIP ON METAL SERIES

PILOT LIGHTS WITH LED BULB









	TYPE	COLOUR	ORDERING CODE	PRICE IN Rs. WITH LED BULB
	Pilot Light			
	LED Bulb, BA9S type	White LED Bulb / White Lens	4PLB1LB(S)	470.00
	24V AC/DC,	Green LED Bulb / Green Lens	4PLB3LB	245.00
	110VAC, 110VDC	Red LED Bulb / Red Lens	4PLB4LB	245.00
	230VAC, 220VDC	Amber LED Bulb / Amber Lens	4PLB5LB	245.00
		Blue LED Bulb / Blue Lens	4PLB6LB	500.00
		White LED Bulb / Clear Lens	4PLB7LB(S)	470.00
		Yellow LED Bulb / Yellow Lens	4PLB8LB	245.00
LED Bulb	Please mention the voltage required after the ordering code			

MRP w.e.f. 10.07.2023

Control & Signalling Devices 22.5 Ø

CLIP ON METAL SERIES

CONTACT ELEMENTS

	TYPE	ORDERING CODE	PRICE IN Rs.
	PANEL MOUNTING		
	NORMALLY OPEN (NO)	C1	72.50
	SILVER CONTACT		
	NORMALLY CLOSED (NC)	C2	72.50
	SILVER CONTACT		
		NORMALLY OPEN (NO)	C3
GOLD CONTACT			
		NORMALLY CLOSED (NC)	C4
	GOLD CONTACT		
		BASE MOUNTING	
NORMALLY OPEN (NO)		C5	72.50
SILVER CONTACT			
	NORMALLY CLOSED (NC)	C6	72.50
	SILVER CONTACT		
		NORMALLY OPEN (NO)	C7
GOLD CONTACT			
		NORMALLY CLOSED (NC)	C8
	GOLD CONTACT		

Common types of control and signalling devices Ø 22.5 Metallic, Clip on Series

Description	Type of Actuator or Lense Assembly	Colour of Actuator or Lense	Contact elements NO=C1 NC=C2 or Lamp Holder	Type of complete Control or Signalling Device	
Flush pushbutton	4AF3	Green	1NO	4PSF310	
	4AF8	Yellow	2NO+1NC	4PSF821	
Projecting pushbutton	4AP2	Black	2NC	4PSP202	
	4AP4	Red	3NO+3NC	4PSF433	
Booted Pushbutton	4AF3+2BT7	Green+clear boot	2NO	4PSF320+2BT7	
	4AF4+2BT7	Red+clear boot	2NC	4PSF402+2BT7	
Mushroom Pushbutton Spring return	4AM2	Black	1NO+1NC	4PSM211	
	4AM4	Red	1NC	4PSM401	
Mushroom Pushbutton Latching turn to release	4AML2	Black	1NC	4PSML201	
	4AML4	Red	2NO+2NC	4PSML422	
Mushroom Pushbutton Latching Key to release	4AMLKB4	Red	1NO+1NC	4PSMLKB411	
Selector Pushbutton-2P	4AS2-2P	Black	1NO	4PSS210-2P	
Selector Pushbutton-3P	4AS2-3P	Black	1NO+1NC	4PSS211-3P	
Key Pushbutton (2Pos) key removable in both positions	4AK2-2PB	Black	1NO	4PSK210-2PB	
Key Pushbutton (3Pos) key removable in left & right positions	4AK2-3PB	Black	1NO+1NC	4PSK211-3PB	
Twin Pushbutton marked "IO"	4ATF3-F4-IO	Flush-Green	1NO	4PSTF310-F401-IO	
Flush-Flush		Flush-Red	1NC		
Twin Pushbutton marked "IO"	4ATF3-P4-IO	Flush-Green	1NO	4PSTF310-P401-IO	
Flush-Projecting		Projecting-Red	1NC		
Flush illuminated pushbutton with multichip LED bulb direct connection	4ALF3LB24DC	Green	1NO+1NC	4PSLF3LB1124DC	
Twin Luminous Pushbutton with "IO" marking Flush-Flush with LED bulb (230VAC)	4ATL5LB-F3-F4230AC-IO	Lense-Amber	1NO	4PSTL5LBF310-F401230AC-IO	
Flush-Flush with LED bulb (230VAC)		Flush-Green	1NO		
Twin Luminous Pushbutton with "IO" marking Flush - Projecting with LED bulb (110VAC)	4ATL5LB-F3-P4110AC-IO	Lense-Amber	1NO	4PSTL5LBF310-P401110AC-IO	
Flush - Projecting with LED bulb (110VAC)		Flush-Green	1NO		
Pilot Light with LED bulb for 24V Bulb:24V	4PLLA5	Amber	4LHB24	4PLB5LB24	
Pilot Light with LED bulb for 230VAC Bulb: 230V	4PLLA5	Amber	4LHB230AC	4PLB5LB230AC	

GENERAL TERMS AND CONDITIONS

General Terms : Prices are ex-works Mumbai
HSN CODE : 85365010 for all the products of this MRP List
GST : 18%

Prices are subject to revision without notice and ruling at the time of delivery.

This price list supersedes all previous Price Lists.

Warranty Policy : TEKNIC equipment is guaranteed under the following terms:

For a period of 12 months from the date of sale, TEKNIC guarantees that its products are free from defects in material and workmanship, with the exception of consumables rendered unserviceable through normal use. During the said period, TEKNIC will replace or repair all parts acknowledged as defective due to factory workmanship and which have been returned in a timely manner by Buyer to TEKNIC and all costs and duties paid, together with a detailed description of the failure and a certified declaration of the number of hours of operation. Repaired or replaced parts will be redelivered FCA (named place) as per INCOTERMS 2000. This warranty is subject to the provision of correct usage, proper maintenance and does not cover defects arising out of fire, faulty operation, accident, inefficient maintenance and willful or accidental damage.

TEKNIC guarantee applies to all equipment, parts and components stored, installed, protected, maintained and used in accordance with TEKNIC specifications and instructions, and respecting the rules for normal use, without any modification by Buyer.

All other conditions or warranties, whether express or implied, relating to the quality and operation of the equipment are excluded, as well as any liability for loss or damage caused directly or indirectly by the equipment or resulting from its use.

Proof of purchase to be provided to avail warranty.

TEKNIC ELECTRIC (I) PVT. LTD.

Reg. Office : 116, Hammersmith Industrial Estate, Mahim (W), Mumbai – 400016.

Head Office : 703/704/705, Madhava, Bandra Kurla Complex, Bandra (E), Mumbai – 400051. Tel : +91-22-42532500

Works : 65, Marol Co-op. Industrial Estate Ltd., M. Vassanji Road, Andheri (East), Mumbai – 400059. Tel : +91-22-42534500

Email : teknico@teknico.co.in mfg@teknico.co.in **Website** : www.teknico.co.in

Control and Signaling Devices Ø 22.5 Clip on Plastic
Series MRP with effect from 10.07.2022



Control and signaling devices Ø 22.5 P4 Clip on series

Salient features

This range of Ø 22.5 P4 Clip on series pushbuttons, selector switches, illuminated switches and pilot lights in engineering plastic construction have been designed to provide the following salient features:

- Economy of space
- Aesthetically elegant
- Robust in materials of construction
- Simple to fix-Snap fitting
- Safe in operation
- Fixing method unaffected by excessive vibration unit does not rotate
- Very good flame resistance
- Shrouded terminals
- Protection against electrical shock
- Resistant to corrosion

Actuators

The circular actuators have black plastic bezels, and are functionally interchangeable on the different types of contact elements.

Contact elements

The contact elements are double break. The elements are interchangeable & can be stacked without additional hardware, 1 to 6 elements (NO or NC) can be used with non illuminated actuators, whereas, 1 to 4 elements (NO or NC) can be used for illuminated actuators. **Gold plated NO and NC contact elements for low voltage, low current switching circuits, < 25 mA, are available. Base mounting elements are also available.**

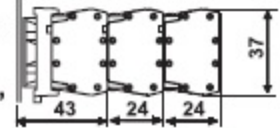

Illuminated pushbuttons & pilot lights

Pilot lights and illuminated switches are suitable for direct connection using bayonet cap multi chip LED bulb (with OAL max 28 mm). Supply voltage using Multichip Led Bulb : 12V-230 VAC / DC

Pilot lights and illuminated actuators are available with LED bulbs suitable for operating at various voltages namely 12V, 24V, 110V and 230V AC/DC.

Terminals

Contact elements and pilot lights are designed to have shrouded terminals with combi screws.

Fixing

The Ø 22,5 P4 Clip on series control devices can be fixed in any position on panels of 1 to 5 mm thickness.

We recommend minimum fixing centres of 30mm X 40mm. However, the dimensions and configuration should be decided on the basis of the application.

The actuators, and the lense assemblies snap fit on the holding bracket.

Details of the assembly shown in diagram.

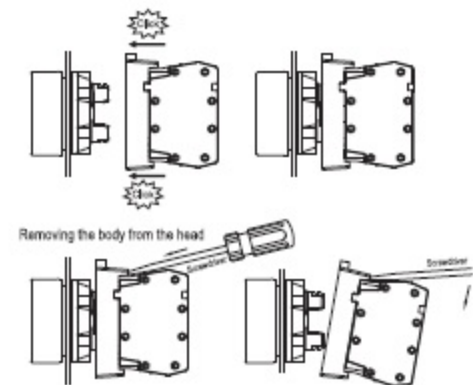
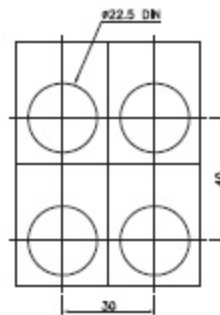

Electrical and mechanical characteristics

Environment

Standards conformity	:	UL 508, EN 60947-5-1
Approvals	:	UL 508
Degree of protection	:	IP 65 as per IEC 60529, NEMA 4X, 12 as per UL 50
Ambient	:	- 25°C to + 70°C
Operating position	:	All positions
Pollution Degree	:	3

Contact Block

Rated insulation voltage	:	500 V																		
Rated thermal current	:	10 A																		
Contact operation	:	Slow break NO or NC																		
Make and break capacity	:	AC 15 4 A, 415 V AC																		
As per IEC 60947 - 5 - 1	:	DC 13 0.5 A, 110 V DC																		
Terminal capacity	:	Maximum 2 x 1.5 mm ² or 1 x 2.5 mm ² .Minimum 1 x 0.5 mm ²																		
Terminal marking	:	1 - 2 for NC & 3 - 4 for NO																		
Short circuit protection	:	10 A HRC cartridge fuse, rated for resistive loading at 1000 A Prospective Current																		
Mechanical life	:	Over 1 million operations																		
Electrical rating	:																			
(for 1 million operating cycles, operating at 3600 cycles per hour, load factor 0.5)	:																			
		<table border="0"> <tr> <td>AC 15</td> <td>V</td> <td>24</td> <td>120</td> <td>230</td> <td>DC 13</td> <td>V</td> <td>24</td> <td>110</td> </tr> <tr> <td></td> <td>A</td> <td>4</td> <td>3</td> <td>2</td> <td></td> <td>A</td> <td>0.5</td> <td>0.2</td> </tr> </table>	AC 15	V	24	120	230	DC 13	V	24	110		A	4	3	2		A	0.5	0.2
AC 15	V	24	120	230	DC 13	V	24	110												
	A	4	3	2		A	0.5	0.2												
Screw clamp tightening torque	:	0.8 Nm (Nominal recommended)																		

Modules for pilot light & illuminated switches with LED bulb (BA9S cap)

Current consumptions (applicable to all colours)

24 V AC/DC, 110 VAC & 240 VAC	:	max. 20 mA
Terminal capacity	:	Maximum 2 x 1.5 mm ² or 1 x 2.5 mm ² . Minimum 1 x 0.5 mm ²
Service life (at nominal voltage and at ambient temperature at 25°C)	:	50,000 hours

MRP w.e.f. 10.07.2023

Control & Signalling Devices 22.5 Ø

CLIP ON PLASTIC SERIES

MOMENTARY ACTUATORS

	TYPE	COLOUR	ORDERING CODE	PRICE IN Rs.
		White	P4AF1	62.00
		Black	P4AF2	62.00
	Flush	Green	P4AF3	62.00
		Red	P4AF4	62.00
		Blue	P4AF6	62.00
		Yellow	P4AF8	62.00
	Flush with Arrow marking	White	P4AF1BA	90.00
		Black	P4AF2WA	90.00
		White	P4AP1	62.00
		Black	P4AP4	62.00
	Projecting	Green	P4AP3	62.00
		Red	P4AP4	62.00
		Blue	P4AP6	62.00
		Yellow	P4AP8	62.00
		White	P4AF1RR	85.00
		Black	P4AF2RR	85.00
	Flush Relay	Green	P4AF3RR	85.00
	Reset Actuators	Red	P4AF4RR	85.00
		Blue	P4AF6RR	85.00
		Yellow	P4AF8RR	85.00
		White	P4AF12BT7	135.00
		Black	P4AF22BT7	135.00
	Booted	Green	P4AF32BT7	135.00
		Red	P4AF42BT7	135.00
		Blue	P4AF62BT7	135.00
		Yellow	P4AF82BT7	135.00

MRP w.e.f. 10.07.2023

Control & Signalling Devices 22.5 Ø

CLIP ON PLASTIC SERIES

MUSHROOM HEAD ACTUATORS

	TYPE	COLOUR	ORDERING CODE	PRICE IN Rs.
				
	Latching	Black	P4AMLS2	145.00
	Ø 30mm	Red	P4AMLS4	145.00
		Black	P4AM2	105.00
	Momentary	Green	P4AM3	105.00
	Ø 40mm	Red	P4AM4	105.00
		Blue	P4AM6	105.00
		Yellow	P4AM8	105.00
				
	Push Pull	Black	P4AMPP4	145.00
	Ø 40 mm	Red	P4AMPP4	145.00
				
	Latching	Black	P4AML2	145.00
	Ø 40mm	Red	P4AML4	145.00
				
	Latching	Black	P4AMLKB2	285.00
	with Key	Red	P4AMLKB4	285.00
	Ø 40mm			

MRP w.e.f. 10.07.2023

Control & Signalling Devices 22.5 Ø

CLIP ON PLASTIC SERIES

MUSHROOM HEAD ACTUATORS

	TYPE	COLOUR	ORDERING CODE	PRICE IN Rs.
	Trigger type	Black	P4AMLT2	215.00
	Press to Lock	Red	P4AMLT4	215.00
	turn to release			
	Ø 40 mm			
	Trigger type	Black	P4AMLTKB2	350.00
	Press to Lock	Red	P4AMLTKB4	350.00
	key to release			
	Ø 40 mm			
		Black	P4AMJ2	145.00
	Momentary	Green	P4AMJ3	145.00
	Ø 60mm	Red	P4AMJ4	145.00
		Blue	P4AMJ6	145.00
		Yellow	P4AMJ8	145.00
	Push Pull	Black	P4AMPPJ2	185.00
	Ø 60 mm	Red	P4AMPPJ4	185.00
	Latching	Black	P4AMLJ2	185.00
	Ø 60mm	Red	P4AMLJ4	185.00

MRP w.e.f. 10.07.2023

Control & Signalling Devices 22.5 Ø

CLIP ON PLASTIC SERIES

SELECTOR ACTUATORS











	TYPE		COLOUR	ORDERING CODE	PRICE IN Rs.	
	Selector 2 position LATCHING		Black	P4AS2-2P	196.00	
	with ext. knob			P4AS2E-2P	196.00	
	2 position MOMENTARY		Black	P4AS2-2PSR	196.00	
	with ext. knob			P4AS2E-2PSR	196.00	
		3 position STAY PUT		Black	P4AS2-3P	196.00
		with ext. knob			P4AS2E-3P	196.00
MOMENTARY on both sides			Black	P4AS2-3PSR	215.00	
with ext. knob				P4AS2E-3PSR	215.00	
MOMENTARY on right			Black	P4AS2-3PSRR	215.00	
with ext. knob				P4AS2E-3PSRR	215.00	
MOMENTARY on left			Black	P4AS2-3PSRL	215.00	
with ext. knob				P4AS2E-3PSRL	215.00	

MRP w.e.f. 10.07.2023

Control & Signalling Devices 22.5 Ø

CLIP ON PLASTIC SERIES





KEY SELECTOR ACTUATORS

	TYPE		COLOUR	ORDERING CODE	PRICE IN Rs.
	2 Position Stayput		Black	P4AK2-2PB	275.00
				P4AK2-2PO	275.00
				P4AK2-2PI	275.00
	Spring Return		Black	P4AK2-2POSR	275.00
	3 Position Stayput		Black	P4AK2-3PA	290.00
			Black	P4AK2-3PB	290.00
			Black	P4AK2-3PC	290.00
	Spring Return		Black	P4AK2-3PSR	290.00
	Right to Centre		Black	P4AK2-3PSRR	290.00
	Left to Centre		Black	P4AK2-3PSRL	290.00
* X stands for position in which key is removable					

MRP w.e.f. 10.07.2023

Control & Signalling Devices 22.5 Ø

CLIP ON PLASTIC SERIES



TWIN ACTUATORS				
	TYPE	COLOUR	ORDERING CODE	PRICE IN Rs.
	Double Flush w/o IO Mark	Green	P4ATF3F4	130.00
		Red		
	Double Flush with IO Mark	Green	P4ATF3F4(IO)	130.00
		Red		
	1 Flush, 1 Projecting w/o IO Mark	Green	P4ATF3P4	130.00
		Red		
	1 Flush, 1 Projecting with IO Mark	Green	P4ATF3P4(IO)	130.00
		Red		

MRP w.e.f. 10.07.2023

Control & Signalling Devices 22.5 Ø

CLIP ON PLASTIC SERIES

ILLUMINATED MOMENTARY ACTUATORS WITH LED BULB



	TYPE	COLOUR	ORDERING CODE	PRICE IN Rs. WITH LED BULB
Illuminated Flush, Momentary				
	LED Bulb, BA9S type	White LED Bulb / White Lens	P4ALF1LB(S)	460.00
	24V AC/DC,	Green LED Bulb / Green Lens	P4ALF3LB	245.00
	110VAC, 110VDC	Red LED Bulb / Red Lens	P4ALF4LB	245.00
	230VAC, 220VDC	Amber LED Bulb / Amber Lens	P4ALF5LB	245.00
		Blue LED Bulb / Blue Lens	P4ALF6LB	485.00
		White LED Bulb/ Clear Lens	P4ALF7LB(S)	460.00
		Yellow LED Bulb / Yellow Lens	P4ALF8LB	245.00
LED Bulb	Please mention the voltage required after the ordering code			
Illuminated Projecting, Momentary				
		White LED Bulb / White Lens	P4ALP1LB(S)	460.00
	LED Bulb, BA9S type	Green LED Bulb / Green Lens	P4ALP3LB	245.00
	24V AC/DC,	Red LED Bulb / Red Lens	P4ALP4LB	245.00
	110VAC, 110VDC	Amber LED Bulb / Amber Lens	P4ALP5LB	245.00
	230VAC, 220VDC	Blue LED Bulb / Blue Lens	P4ALP6LB	485.00
		White LED Bulb/ Clear Lens	P4ALP7LB(S)	460.00
		Yellow LED Bulb / Yellow Lens	P4ALP8LB	245.00
LED Bulb	Please mention the voltage required after the ordering code			

MRP w.e.f. 10.07.2023

Control & Signalling Devices 22.5 Ø

CLIP ON PLASTIC SERIES

ILLUMINATED SELECTOR ACTUATOR WITH LED BULB

	TYPE	COLOUR	ORDERING CODE	PRICE IN Rs. WITH LED BULB	
	2 Position illuminated selector actuator				
	LED Bulb BA9S type	White LED Bulb / White Lens	P4ASL1LB(S)-2P	625.00	
	24V AC/DC,	Green LED Bulb / Green Lens	P4ASL3LB-2P	395.00	
	110VAC, 110VDC	Red LED Bulb / Red Lens	P4ASL4LB-2P	395.00	
	230VAC, 220VDC	Amber LED Bulb / Amber Lens	P4ASL5LB-2P	395.00	
		Blue LED Bulb / Blue Lens	P4ASL6LB-2P	655.00	
		White LED Bulb / Clear Lens	P4ASL7LB(S)-2P	625.00	
		Yellow LED Bulb / Yellow Lens	P4ASL8LB-2P	395.00	
	Please mention the voltage required after the ordering code				
	LED Bulb BA9S type	White LED Bulb / White Lens	P4ASL1LB(S)-2PSR	625.00	
	24V AC/DC,	Green LED Bulb / Green Lens	P4ASL3LB-2PSR	395.00	
	110VAC, 110VDC	Red LED Bulb / Red Lens	P4ASL4LB-2PSR	395.00	
	230VAC, 220VDC	Amber LED Bulb / Amber Lens	P4ASL5LB-2PSR	395.00	
		Blue LED Bulb / Blue Lens	P4ASL6LB-2PSR	655.00	
		White LED Bulb / Clear Lens	P4ASL7LB(S)-2PSR	625.00	
		Yellow LED Bulb / Yellow Lens	P4ASL8LB-2PSR	395.00	
	LED Bulb	Please mention the voltage required after the ordering code			

MRP w.e.f. 10.07.2023

Control & Signalling Devices 22.5 Ø

CLIP ON PLASTIC SERIES

ILLUMINATED SELECTOR WITH LED BULB

	TYPE	COLOUR	ORDERING CODE	PRICE IN Rs. WITH LED BULB	
3 Position Illuminated Selector Actuator					
	Stayput	White LED Bulb / White Lens	P4ASL1LB(S)-3P	645.00	
	LED Bulb BA9S type	Green LED Bulb / Green Lens	P4ASL3LB-3P	420.00	
	24V AC/DC,	Red LED Bulb / Red Lens	P4ASL4LB-3P	420.00	
	110VAC, 110VDC	Amber LED Bulb / Amber Lens	P4ASL5LB-3P	420.00	
	230VAC, 220VDC	Blue LED Bulb / Blue Lens	P4ASL6LB-3P	670.00	
		White LED Bulb/ Clear Lens	P4ASL7LB(S)-3P	645.00	
		Yellow LED Bulb / Yellow Lens	P4ASL8LB-3P	420.00	
	Please mention the voltage required after the ordering code				
		Momentary	White LED Bulb / White Lens	P4ASL1LB(S)-3PSR	655.00
		LED Bulb BA9S type	Green LED Bulb / Green Lens	P4ASL3LB-3PSR	425.00
		24V AC/DC,	Red LED Bulb / Red Lens	P4ASL4LB-3PSR	425.00
		110VAC, 110VDC	Amber LED Bulb / Amber Lens	P4ASL5LB-3PSR	425.00
		230VAC, 220VDC	Blue LED Bulb / Blue Lens	P4ASL6LB-3PSR	680.00
			White LED Bulb / Clear Lens	P4ASL7LB(S)-3PSR	655.00
			Yellow LED Bulb / Yellow Lens	P4ASL8LB-3PSR	425.00
Please mention the voltage required after the ordering code					
	Momentary / Stayput	White LED Bulb / White Lens	P4ASL1LB(S)-3PSRL	655.00	
	LED Bulb BA9S type	Green LED Bulb / Green Lens	P4ASL3LB-3PSRL	425.00	
	24V AC/DC,	Red LED Bulb / Red Lens	P4ASL4LB-3PSRL	425.00	
	110VAC, 110VDC	Amber LED Bulb / Amber Lens	P4ASL5LB-3PSRL	425.00	
	230VAC, 220VDC	Blue LED Bulb / Blue Lens	P4ASL6LB-3PSRL	680.00	
		White LED Bulb/ Clear Lens	P4ASL7LB(S)-3PSRL	655.00	
		Yellow LED Bulb / Yellow Lens	P4ASL8LB-3PSRL	425.00	
	Please mention the voltage required after the ordering code				
	Momentary / Stayput	White LED Bulb / White Lens	P4ASL1LB(S)-3PSRR	655.00	
	LED Bulb BA9S type	Green LED Bulb / Green Lens	P4ASL3LB-3PSRR	425.00	
	24V AC/DC,	Red LED Bulb / Red Lens	P4ASL4LB-3PSRR	425.00	
	110VAC, 110VDC	Amber LED Bulb / Amber Lens	P4ASL5LB-3PSRR	425.00	
	230VAC, 220VDC	Blue LED Bulb / Blue Lens	P4ASL6LB-3PSRR	680.00	
		White LED Bulb / Clear Lens	P4ASL7LB(S)-3PSRR	655.00	
		Yellow LED Bulb / Yellow Lens	P4ASL8LB-3PSRR	425.00	
	LED Bulb	Please mention the voltage required after the ordering code			

MRP w.e.f. 10.07.2023

Control & Signalling Devices 22.5 Ø

CLIP ON PLASTIC SERIES

TWIN ILLUMINATED ACTUATORS WITH LED



	TYPE	COLOUR	ORDERING CODE	PRICE IN Rs. WITH LED BULB
	Twin Illuminated 1 Flush, 1 Projecting, (IO) Mark			
	LED Bulb, BA9S type 24V AC/DC, 110VAC, 110VDC, 230VAC, 220VDC	Green	P4ATL5LBF3P4 (IO)	330.00
		Red		
		Amber Lens / Amber LED		
	Please mention the voltage required after the ordering code			
	Twin Illuminated Double Flush, (IO) Mark			
	LED Bulb, BA9S type 24V AC/DC, 110VAC, 110VDC, 230VAC, 220VDC	Green	P4ATL5LBF3F4 (IO)	330.00
		Red		
		Amber Lens / Amber LED		
	Please mention the voltage required after the ordering code			
LED Bulb	Please mention the voltage required after the ordering code			

MRP w.e.f. 10.07.2023

Control & Signalling Devices 22.5 Ø

CLIP ON PLASTIC SERIES

MUSHROOM ILLUMINATED ACTUATORS, LATCHING, WITH LED BULB

	TYPE	COLOUR	ORDERING CODE	PRICE IN Rs. WITH LED BULB
	Mushroom Illuminated Actuator, Trigger Type, Press to Lock - Turn to release			
	LED Bulb, BA9S type 24V AC/DC, 110VAC, 110VDC, 230VAC, 220VDC	Red	P4ALMLT4LB	605.00
	Please mention the voltage required after the ordering code			
	TYPE	COLOUR	ORDERING CODE	PRICE IN Rs. WITH LED BULB
	Mushroom Illuminated Actuator, Trigger Type, Push to Lock - Pull to release			
	LED Bulb, BA9S type 24V AC/DC, 110VAC, 110VDC, 230VAC, 220VDC	Red	P4ALMPPT4LB	605.00
	Please mention the voltage required after the ordering code			



MRP w.e.f. 10.07.2023

Control & Signalling Devices 22.5 Ø







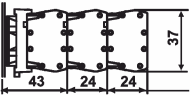
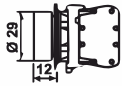

CLIP ON PLASTIC SERIES

PILOT LIGHTS

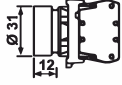
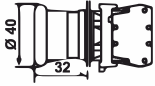
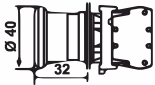
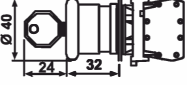
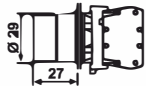
	TYPE	COLOUR	ORDERING CODE	PRICE IN Rs. WITH LED BULB
	Pilot Light with LED Bulb			
	LED Bulb, BA9S type 24V AC/DC, 110VAC, 110VDC, 230VAC, 220VDC	White LED Bulb / White Lens	P4PLB1LB(S)	425.00
		Green LED Bulb / Green Lens	P4PLB3LB	215.00
		Red LED Bulb / Red Lens	P4PLB4LB	215.00
		Amber LED Bulb / Amber Lens	P4PLB5LB	215.00
		Blue LED Bulb / Blue Lens	P4PLB6LB	450.00
		White LED Bulb / Clear Lens	P4PLB7LB(S)	425.00
		Yellow LED Bulb / Yellow Lens	P4PLB8LB	215.00
LED Bulb	Please mention the voltage required after the ordering code			

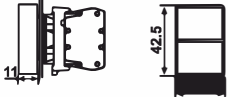
CLIP ON PLASTIC SERIES			
CONTACT ELEMENTS			
	TYPE	ORDERING CODE	PRICE IN Rs.
	PANEL MOUNTING		
	NORMALLY OPEN (NO) SILVER CONTACT	C1	72.50
	NORMALLY CLOSED (NC) SILVER CONTACT	C2	72.50
	NORMALLY OPEN (NO) GOLD CONTACT	C3	195.00
	NORMALLY CLOSED (NC) GOLD CONTACT	C4	195.00
BASE MOUNTING			
	NORMALLY OPEN (NO) SILVER CONTACT	C5	72.50
	NORMALLY CLOSED (NC) SILVER CONTACT	C6	72.50
	NORMALLY OPEN (NO) GOLD CONTACT	C7	195.00
	NORMALLY CLOSED (NC) GOLD CONTACT	C8	195.00

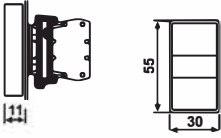
Common types of control and signalling devices Ø 22.5 P4 Clip on series

Description	Type of Actuator or Lense Assembly	Colour of Actuator or Lense	Contact Elements NO = C1 NC = C2 or Lamp Holder	Type of complete Control or Signalling Device	
Flush Pushbutton	P4AF3	Green	1NO	P4PSF310	
	P4AF8	Yellow	2NO+1NC	P4PSF821	
Projecting Pushbutton	P4AP2	Black	2NC	P4PSP202	
	P4AP4	Red	3NO+3NC	P4PSP433	
Booted Pushbutton	P4AF3+2BT7	Green + clear boot	2NO	P4PSF320+2BT7	
	P4AF4+2BT7	Red + clear boot	2NC	P4PSF402+2BT7	
Mushroom Pushbutton Spring return	P4AM2	Black	1NO+1NC	P4PSM211	
	P4AM4	Red	1NC	P4PSM401	
Mushroom Pushbutton latching turn to release	P4AML2	Black	1NC	P4PSML201	
	P4AML4	Red	2NO+2NC	P4PSML422	
Mushroom Pushbutton latching, key to release	P4AMLKB4	Red	1NO+1NC	P4PSMLKB411	
Selector Actuator (2 Pos)	P4AS2-2P	Black	1NO	P4PSS210-2P	
Selector Actuator (3 Pos)	P4AS2-3P	Black	1NO+1NC	P4PSS211-3P	
Key Actuator (2 Pos), key removable in both positions Key Actuator (3 Pos), key removable in left & right positions	P4AK2-2PB		1NO	P4PSK210-2PB	
	P4AK2-3PB		1NO+1NC	P4PSK211-3PB	
Twin Pushbutton marked "I O" Flush - Flush	P4ATF2-F4-IO	Flush-Green Flush-Red	1 NO 1 NC	P4PSTF310-F401-IO	
Flush Illuminated Pushbutton with multichip LED bulb, direct connection	P4ALF3LB24DC	Green	1NO+1NC	P4PSLF3LB1124	
Twin Luminous Pushbutton Without "I O" making Flush - Flush with LED Bulb (240V AC)	P4ATL5LB-F3 -F4230AC	Lense-Amber Flush-Green Flush-Red	1 NO 1 NC	P4PSTL5LBF310-F401230AC	
Pilot Light with LED bulb for 230V AC Bulb: 230V	P4PLLA5	Amber	4LHLB230	P4PLB5LB230	

GENERAL TERMS AND CONDITIONS

General Terms : Prices are ex-works Mumbai
HSN CODE : 85365010 for all the products of this MRP List
GST : 18%

Prices are subject to revision without notice and ruling at the time of delivery.

This price list supersedes all previous Price Lists.

Warranty Policy : **TEKNIC equipment is guaranteed under the following terms:**

For a period of 12 months from the date of sale, TEKNIC guarantees that its products are free from defects in material and workmanship, with the exception of consumables rendered unserviceable through normal use. During the said period, TEKNIC will replace or repair all parts acknowledged as defective due to factory workmanship and which have been returned in a timely manner by Buyer to TEKNIC and all costs and duties paid, together with a detailed description of the failure and a certified declaration of the number of hours of operation. Repaired or replaced parts will be redelivered FCA (named place) as per INCOTERMS 2000. This warranty is subject to the provision of correct usage, proper maintenance and does not cover defects arising out of fire, faulty operation, accident, inefficient maintenance and willful or accidental damage.

TEKNIC guarantee applies to all equipment, parts and components stored, installed, protected, maintained and used in accordance with TEKNIC specifications and instructions, and respecting the rules for normal use, without any modification by Buyer.

All other conditions or warranties, whether express or implied, relating to the quality and operation of the equipment are excluded, as well as any liability for loss or damage caused directly or indirectly by the equipment or resulting from its use.

Proof of purchase to be provided to avail warranty.

TEKNIC ELECTRIC (I) PVT. LTD.

Reg. Office : 116, Hammersmith Industrial Estate, Mahim (W), Mumbai – 400016.
Head Office : 703/704/705, Madhava, Bandra Kurla Complex, Bandra (E), Mumbai – 400051. Tel : +91-22-42532500
Works : 65, Marol Co-op. Industrial Estate Ltd., M. Vassanji Road, Andheri (East), Mumbai – 400059. Tel : +91-22-42534500
Email : teknico@teknico.co.in mfg@teknico.co.in Website : www.teknico.co.in

Control and Signaling Devices Ø 30.5 Series

MRP with effect from 10.07.2023

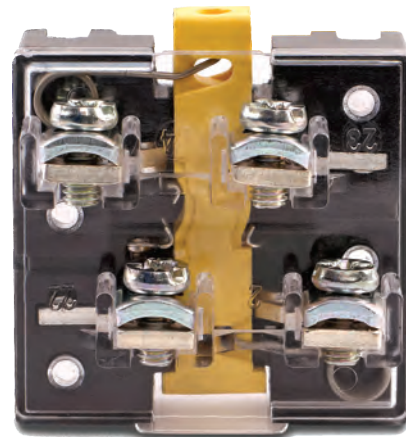

SALIENT FEATURES

The Ø30.5 range of pushbuttons, selector actuators, pilot lights and illuminated pushbuttons have been designed to provide the following salient features:

- Aesthetically elegant
- Easy and rapid mounting
- Dust, moisture and oil tight
- Robust in material of construction
- SELF WIPING CONTACTS
- Safe in operation
- Long mechanical and electrical life

The control devices are designed for flush mounting on control panels, desks and machines with plate thickness upto 6mm. Their dust, moisture and oil tight construction make them specially suitable for application in power plants, steel plants, cement plants, coal handling plants, foundries machine tools etc. Booted pushbuttons are used in very dusty atmospheres.

The pushbuttons comprises of the actuators and contact element. The actuator is designed to contain a full umbrella type of special rubber diaphragm inside the actuator housing in order to provide dust, moisture and oil tight onstruction. The different types of actuators include shrouded, unshrouded booted, mushroom spring return or stayput, mushroom jumbo, selector, key, luminous. Different versions including dust proofing version are described in detail in TEKNIC price list.

The contact element comprises of a contact housing, fixed and moving silver tipped contacts, a slider and a transparent cover through which the contacts can be inspected in operation. Contacts are double break are **self wiping** which ensures long life. Each contact element provides 1NO and 1NC contact. Each unit can take upto 4 contact elements. Separate contact elements can be used on different phases or polarities.

The pilot lights and illuminated pushbuttons are suitable for direct supply or supply through series resistor, using bayonet cap filament bulb.

The pilot light can also be provided with neon bulbs. Replacement of the bulb is easily done by unscrewing the front ring, holding the lense. Pilot lights can be provided with either glass or polycarbonate lenses in the following standard colours

- | | |
|---------------------|---------|
| • TRANSLUCENT WHITE | • AMBER |
| • GREEN | • BLUE |
| • RED | • CLEAR |

Supply voltage for direct connection or without series resistor: 6V-230V
Supply voltage for direct connection with series resistor : 24V-230V
Pilot lights can also be supplied with neon bulbs upto a voltage of 500V

FIXING

The control devices Ø30.5 can be fixed in any position on panel of 1 to 6mm thickness. They are secured from the front by means of a fixing ring. A set of rubber gaskets is supplied to provide water proofing and tightness between the unit and the panel. The exact number of rubber gaskets is to be selected depending upon the panel thickness. Fixing centres of 60mm are recommended between control stations to provide sufficient space for convenient terminal connections and assembly of legend plates.

The pushbutton can be either be mounted as complete unit on the front of the panel or the contact can be individually mounted with the actuator on the panel front plate. Also the pilot light can either be mounted as a complete unit on the front of the panel or the pilot light holder can be individually mounted with the lense on the front of the panel.

ELECTRICAL AND MECHANICAL CHARACTERISTICS

Rated insulation voltage	: 500V AC, 600V DC
Rated thermal current	: 10A
Contact operation	: Self wiping, slow double break, 1 NO + 1 NC
Make and break capacity (13947-5-1)	: AC15: 4A 415V : DC13: 0.5A 110V
Terminal capacity	: Maximum 2x1.5mm ² : Minimum 1X0.5mm ²
Ambient temperature	: -25°C to +70°C
Altitude	: < 3000 metres
Operating position	: All positions
Degree of protection	: IP 65
Mechanical life	: Over 1 million operations

ORDERING INSTRUCTIONS

1. Actuators, illuminated actuators, contact elements, pilot lights can be ordered separately or in combination.
2. No prefix before all actuators and combinations indicates Ø30.5 series
3. Numerical colour code has been added as suffix to indicate colour of the actuator or lense as follows:

Colour of Actuator:	White	Black	Green	Red	Yellow	Blue	-
Colour of Lense:	Translucent white	-	Green	Red	Amber	Blue	Clear
Colour code:	1	2	3	4	5	6	7
4. The type number of contact elements are S11, S12, S21, S22. All these have 1NO+1NC contacts. S11 is for mounting directly to actuator and S12 for coupling to S11 for obtaining 2NO+2NC. S21 is for individual mounting and S22 is for coupling for S21 for 2NO+2NC

BULBS

Filament Bulbs type BA15d

Voltage:	6	12	24	48	110	220
Wattage (max)	5-7	5-7	5-7	5-7	5-7	5-7

LEGEND PLATES

Legend plates are supplied with the following standards texts

START	FORWARD	UP	ON	OPEN	AUTO	SLOW	RESET
STOP	REVERSE	DOWN	OFF	CLOSE	HAND	FAST	INCH

TYPE NUMBERS

Some examples of type number

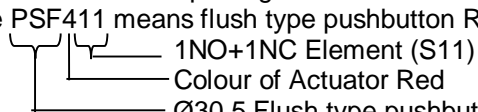
Actuator	Type AF3 means type actuator Ø30.5 GREEN
Pilot Light	Type PLB4 means pilot light without resistor RED Type PLBR3 means pilot light with series resistor GREEN
Complete Pushbutton	Type PSF411 means flush type pushbutton RED with 1NO+1NC 







MRP w.e.f. 10.07.2023











Control & Signalling Devices 30.5 Ø



NON ILLUMINATED ACTUATOR				
	TYPE	COLOUR	ORDERING CODE	PRICE IN Rs.
		White	AF1	135.00
		Black	AF2	135.00
	Flush Momentary	Green	AF3	135.00
		Red	AF4	135.00
		Blue	AF6	135.00
		Yellow	AF8	135.00
		White	AP1	135.00
		Black	AP2	135.00
	Projecting Momentary	Green	AP3	135.00
		Red	AP4	135.00
		Blue	AP6	135.00
		Yellow	AP8	135.00
		Black	AB2	240.00
		Green	AB3	240.00
	Booted Momentary	Red	AB4	240.00
		Blue	AB6	240.00
		Yellow	AB8	240.00
				
	Mushroom Momentary	Black	AM2	150.00
	Head Ø 40mm	Red	AM4	150.00
				
	Jumbo Mushroom	Black	AMJ2	240.00
	Momentary	Red	AMJ4	240.00
	Head Ø 60mm			

MRP w.e.f. 10.07.2023

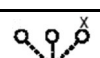
Control & Signalling Devices 30.5 Ø

NON ILLUMINATED ACTUATOR				
	TYPE	COLOUR	ORDERING CODE	PRICE IN Rs.
	MUSHROOM HEAD ACTUATOR			
	Mushroom	Black	AML2	220.00
	Latching	Red	AML4	220.00
	Head Ø 40mm			
	Jumbo Mushroom	Black	AMLJ2	310.00
	Latching	Red	AMLJ4	310.00
	Head Ø 60mm			
	Key Mushroom			
	Latching	Red	AMLKB4	425.00
	Head Ø 40mm			
	SELECTOR ACTUATOR			
	2 Position			
	STAY PUT	Black	AS2-2P	275.00
				
	2 Position			
	MOMENTARY	Black	AS2-2PSR	275.00
				
	3 Position			
STAY PUT	Black	AS2-3P	275.00	
				





NON ILLUMINATED ACTUATOR						
	TYPE	COLOUR	COLOUR	ORDERING CODE	PRICE IN Rs.	
	KEY SELECTOR					
	2 Position Stayput		Black	AK-2PB	410.00	
				AK-2PO	410.00	
				AK-2PI	410.00	
				AK-2POSR	410.00	
	Spring Return					
	3 Position Stayput		Black	AK-3PA	430.00	
				AK-3PB	430.00	
				AK-3PO	430.00	
				AK-3PI	430.00	
						
	* X stands for position in which key is removable					

ILLUMINATED FLUSH ACTUATOR WITH LED BULB					
	TYPE	COLOUR	ORDERING CODE	PRICE IN Rs. INTEGRAL LED	PRICE IN Rs. WITH LED BULB
	Illuminated Flush Actuator, Spring Return				
	LED Bulb, MCB15 type	White LED Bulb / White Lens	ALF1LB(S)		630.00
	24V AC/DC,	Green LED Bulb / Green Lens	ALF3LB		365.00
	110VAC, 110VDC	Red LED Bulb / Red Lens	ALF4LB		365.00
	230VAC, 220VDC	Amber LED Bulb / Amber Lens	ALF5LB		365.00
		Blue LED Bulb / Blue Lens	ALF6LB		660.00
		White LED Bulb / Clear Lens	ALF7LB(S)		630.00
		Yellow LED Bulb / Yellow Lens	ALF8LB		365.00
LED Bulb	Please mention the voltage required after the ordering code				
	PILOT LIGHT				
	Integral LED	White LED / White Lens	PLBR1L(S)	430.00	
	6V, 12V, 24V, 48V AC/DC	Green LED / Green Lens	PLBR3L	290.00	
	110VAC, 110VDC,	Red LED / Red Lens	PLBR4L	290.00	
	230VAC, 220VDC	Amber LED / Amber Lens	PLBR5L	290.00	
		Blue LED / Blue Lens	PLBR6L	575.00	
		White LED / Clear Lens	PLBR7L(S)	430.00	
		Yellow LED / Yellow Lens	PLBR8L	290.00	
Integral LED	Please mention the voltage required after the ordering code				
					
		White LED Bulb / White Lens	PLB1LB(S)		560.00
	LED Bulb, MCB15 type	Green LED Bulb / Green Lens	PLB3LB		310.00
	24V AC/DC,	Red LED Bulb / Red Lens	PLB4LB		310.00
	110VAC, 110VDC	Amber LED Bulb / Amber Lens	PLB5LB		310.00
	230VAC, 220VDC	Blue LED Bulb / Blue Lens	PLB6LB		590.00
		White LED Bulb / Clear Lens	PLB7LB(S)		560.00
		Yellow LED Bulb / Yellow Lens	PLB8LB		310.00
	LED Bulb	Please mention the voltage required after the ordering code			



MRP w.e.f. 10.07.2023

Control & Signalling Devices 30.5 Ø

CONTACT ELEMENTS			
	TYPE	ORDERING CODE	PRICE IN Rs.
 <p>S11 S12</p>  <p>S11 + S12</p>	ACTUATOR MOUNTING		
	1NO+1NC	S11	250.00
	1NO+1NC coupled to S11 to provide 2NO+2NC	S12	250.00
 <p>S21 S22</p>  <p>S21 + S22</p>	BASE MOUNTING		
	1NO+1NC	S21	250.00
	1NO+1NC coupled to S21 to provide 2NO+2NC	S22	250.00

Control and signalling devices $\phi 30.5$

Some common types

Description	Type of Actuator	Type of Actuator or Lense	Colour of Element S11 (1NO + 1NC)	Type of Complete Control Device
Flush Pushbutton	AF3	Green	1NO + 1NC	PSF311
	AF8	Yellow	2NO + 2NC	PSF822
Projecting Pushbutton	AP2	Black	1NO + 1NC	PSP211
	AP4	Red	3NO + 3NC	PSP433
Booted Pushbutton	AB3	Green	1NO + 1NC	PSB311
	AB4	Red	2NO + 2NC	PSB422
Mushroom Pushbutton (Spring return)	AM2	Black	1NO + 1NC	PSM211
Mushroom Jumbo Pushbutton (Spring return)	AMJ4	Red	4NO + 4NC	PSMJ444
Mushroom Pushbutton Latching. Turn to Release.	AML2	Black	1NO + 1NC	PSML211
	AML4	Red	2NO + 2NC	PSML422
Mushroom Pushbutton Latching. Key to Release.	AMLKB4	Red	1NO + 1NC	PSMLKB411
Selector Actuator (2 Pos.)	AS2-2P	Black	1NO + 1NC	PSS211-2P
Selector Actuator (3 Pos.)	AS2-3P	Black	2NO + 2NC	PSS222-3P
Key Actuator (2 Pos.)	AK2-2P		1NO + 1NC	PSK211-2P
Key Actuator (3 Pos.)	AK2-3P		2NO + 2NC	PSK222-3P
Pilot Light for direct connection upto 230V (LED Bulb)		Red		PLB4LB (240V AC)
Pilot Light through series resistor for 230V (LED Bulb)		Green		PLBR3LB (240V AC)
Illuminated Pushbutton direct connection upto 230V (LED Bulb)	AL5LB	Amber	1NO + 1NC	PSL5LB11 (230V)

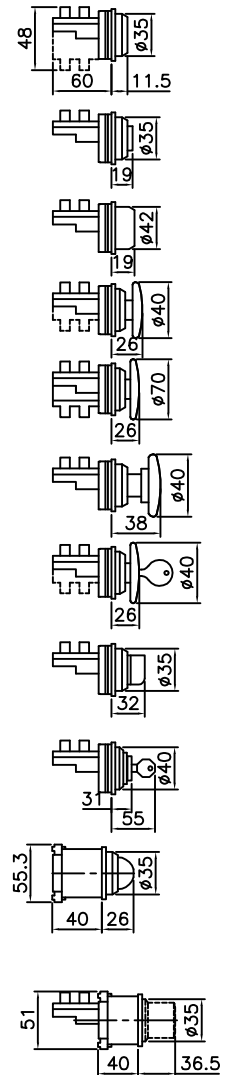

Other products include terminals, appliance controlgear and $\phi 22.5$ controlgear products



GENERAL TERMS AND CONDITIONS

General Terms : Prices are ex-works Mumbai
HSN CODE : 85365010 for all the products of this MRP List
GST : 18%

Prices are subject to revision without notice and ruling at the time of delivery.

This price list supersedes all previous Price Lists.

Warranty Policy : TEKNIC equipment is guaranteed under the following terms:

For a period of 12 months from the date of sale, TEKNIC guarantees that its products are free from defects in material and workmanship, with the exception of consumables rendered unserviceable through normal use. During the said period, TEKNIC will replace or repair all parts acknowledged as defective due to factory workmanship and which have been returned in a timely manner by Buyer to TEKNIC and all costs and duties paid, together with a detailed description of the failure and a certified declaration of the number of hours of operation. Repaired or replaced parts will be redelivered FCA (named place) as per INCOTERMS 2000. This warranty is subject to the provision of correct usage, proper maintenance and does not cover defects arising out of fire, faulty operation, accident, inefficient maintenance and willful or accidental damage.

TEKNIC guarantee applies to all equipment, parts and components stored, installed, protected, maintained and used in accordance with TEKNIC specifications and instructions, and respecting the rules for normal use, without any modification by Buyer.

All other conditions or warranties, whether express or implied, relating to the quality and operation of the equipment are excluded, as well as any liability for loss or damage caused directly or indirectly by the equipment or resulting from its use.

Proof of purchase to be provided to avail warranty.

TEKNIC ELECTRIC (I) PVT. LTD.

Reg. Office : 116, Hammersmith Industrial Estate, Mahim (W), Mumbai – 400016.

Head Office : 703/704/705, Madhava, Bandra Kurla Complex, Bandra (E), Mumbai – 400051. Tel : +91-22-42532500

Works : 65, Marol Co-op. Industrial Estate Ltd., M. Vassanji Road, Andheri (East), Mumbai – 400059. Tel : +91-22-42534500

Email : teknico@teknico.co.in mfg@teknico.co.in Website : www.teknico.co.in

Control & Signalling devices Ø 22.5 plastic construction
Monoblock Series

MRP with effect from 10.07.2022



Control and Signalling Device in plastic construction

Salient Features

This range of Ø 22.5 devices plastic series namely Push Button switches, Selector Switches, Emergency Switches, Pilot Lights in engineering Plastic Construction, have been designed to provide our OEM customers and Panel Builders a compact series of products with a competitive edge. This range ensures cost efficiency and provides a high level of reliability and economy. Technical Features includes:

- Safe in Operation • Enables Control on inventory • Reliable performance • All in one function - complete function in one order code • Low built in Depth
- Single or two built in electrically separated contacts are provided (either 1 NO, 1NC, 2NO, 2NC or 1NO+1NC) • Economy of Space • Aesthically elegant
- Robust design • Larger operating surface than Ø 30.5 • Easy Mounting

PUSH BUTTONS

The monoblock push buttons are circular in design, Ø 22.5. The combination is of an actuator and contact element, single or two built in electrically separated contacts 1NO, 1NC, 2NO, 2NC or 1NO+1NC. Different varieties / colours of Actuators available are described separately herewith with their images, where the respective dimensions of the devices are also given.

PILOT LIGHTS:

Pilot Lights are available with integral LEDs, suitable for operating at various voltages, namely 6V, 12V, 24V, 30V, 48V, 63V, 110V, 125V AC/DC, 240VAC & 220VDC. Any other voltage & test function available on request. The pilot lights can also be offered with dual colour LEDs with different colour combinations for 12V to 240V AC/DC. The pilot lights with integral LEDs are also available suitable for operating at any universal voltage between 24V and 240V AC/DC.

Terminals

Push Button Contacts and Pilot Lights are designed to have shrouded terminals with Combi Screws.

Fixing

The integrated push button and pilot light range can be fixed in any position on panels of 1 to 5 mm thickness. The recommended fixing centres are 30 mm x 40 mm. The push button and pilot light are fixed on the panel with the help of locking nut.

Specifications of 103 series:

Details of these control devices, Ø 22.5 are detailed below:

A. Mechanical Durability

Push Button	Spring Return	Million Operations	1
	Selector		0.5
	Latching Type		0.1
	Mushroom Type		0.02

B. Standards & Conditions

Applicable Standard	UL 508, IEC 60947-5-1, CSA 22.2
Degree of Protection	IP54 (as per IEC 60947-5-1)
Operating Conditions	+70°C to -25°C
Mounting	Confirming to IEC 60947-5-1 Finished fixing hole: 22.5mm recommended (22.3+0.4/0) Fixing Centres: 30*40mm Min, (Unless otherwise indicated) Mounting Panel thickness: metal: 1 to 6mm, double insulated: 2 to 6mm

C. Electrical Characteristics

Rating		For AC: C300=120V, make current 15A & break current 1.5A (Thermal current = 2.5A) For DC: R300= 125V make or break current 0.22A, (Thermal current = 1.0A)
Type of contact		N/C or N/O or C/O Slow Break
Positive operation		All functions incorporating an NC contact have positive opening (IEC 60947-5-1)
Terminal Capacity	Cabling	2X1.5mm ² (Pin type lugs) 1X0.5mm ² (min) (Pin / fork type lugs) 1X2.5mm (max) (Pin / fork type lugs)
Screw Clamp tightening torque		0.8 N.m. (nominal recommended) 1.2 N.m(Max)
Short Circuit Protection		4A (gG cartridge fuse) (IEC 60947-5-1)
Rated insulation Voltage		Ui = 250V (Degree of pollution 3)
Rated impulse withstand voltage		Uimp = 6kV (IEC 60947-1)
Dielectric Test		2.5KV (IEC 60947-5-1)
Rated insulation resistance		50MΩ (IEC 60947-1)
Vibration Test		15 gn (Frequency 40-500 Hz) (IEC 60068-2-6)
Shock Test		70 gn (½ sine wave for 6ms) (IEC 60068-2-27)
	Emergency stop	15 g (½ sine wave for 11ms) (IEC 60068-2-27)

D. Pilot light with integral LED / multichip LED bulb (BA9S cap)

Current consumptions (applicable to all colours)	
24 VAC/DC, 110 VAC & 240 VAC	max. 20 mA
110 VDC	max. 10 mA
220 VDC	max. 10 mA
Service life (at nominal voltage & at ambient temperature of 25 °C)	50,000 hours
Voltage limits (nominal voltage)	< 20% of rated voltage >
Short circuit protection	on specific request
Terminal capacity	min. 1 x 0.5 mm ² , max. 2 x 1.5 mm ² or 1 x 2.5 mm ²

MRP w.e.f. 10.07.2023

Control & Signalling Devices 22.5 Ø
PLASTIC SERIES (ECONOMY SERIES)

MOMENTARY FLUSH PUSH BUTTONS

	TYPE	COLOUR	ORDERING CODE	PRICE IN Rs.
		White	3PSF110	110.00
	Flush push	Black	3PSF210	110.00
	button with 1NO	Green	3PSF310	110.00
	contact element	Red	3PSF410	110.00
		Blue	3PSF610	110.00
		Yellow	3PSF810	110.00
		White	3PSF101	110.00
	Flush push	Black	3PSF201	110.00
	button with 1NC	Green	3PSF301	110.00
	contact element	Red	3PSF401	110.00
		Blue	3PSF601	110.00
		Yellow	3PSF801	110.00
		White	3PSF111	150.00
	Flush push	Black	3PSF211	150.00
	button with	Green	3PSF311	150.00
	1NO+1NC	Red	3PSF411	150.00
	contact element	Blue	3PSF611	150.00
		Yellow	3PSF811	150.00
		White	3PSF120	150.00
	Flush push	Black	3PSF220	150.00
	button with 2NO	Green	3PSF320	150.00
	contact element	Red	3PSF420	150.00
		Blue	3PSF620	150.00
		Yellow	3PSF820	150.00
		White	3PSF102	150.00
		Black	3PSF202	150.00
	Flush push	Green	3PSF302	150.00
	button with 2NC	Red	3PSF402	150.00
	contact element	Blue	3PSF602	150.00
		Yellow	3PSF802	150.00



MRP w.e.f. 10.07.2023

Control & Signalling Devices 22.5 Ø
PLASTIC SERIES (ECONOMY SERIES)

LATCHING FLUSH PUSH BUTTONS

	TYPE	COLOUR	ORDERING CODE	PRICE IN Rs.
		White	3PSFPP110	125.00
	Flush push -	Black	3PSFPP210	125.00
	push button with	Green	3PSFPP310	125.00
	1NO contact element	Red	3PSFPP410	125.00
		Blue	3PSFPP610	125.00
		Yellow	3PSFPP810	125.00
		White	3PSFPP101	125.00
	Flush push -	Black	3PSFPP201	125.00
	push button with	Green	3PSFPP301	125.00
	1NC contact element	Red	3PSFPP401	125.00
		Blue	3PSFPP601	125.00
		Yellow	3PSFPP801	125.00
		White	3PSFPP111	165.00
	Flush push -	Black	3PSFPP211	165.00
	push button with	Green	3PSFPP311	165.00
	1NO+1NC	Red	3PSFPP411	165.00
	contact element	Blue	3PSFPP611	165.00
		Yellow	3PSFPP811	165.00
		White	3PSFPP120	165.00
	Flush push -	Black	3PSFPP220	165.00
	push button with	Green	3PSFPP320	165.00
	2NO contact element	Red	3PSFPP420	165.00
		Blue	3PSFPP620	165.00
		Yellow	3PSFPP820	165.00
		White	3PSFPP102	165.00
	Flush push -	Black	3PSFPP202	165.00
	push button with	Green	3PSFPP302	165.00
	2NC contact element	Red	3PSFPP402	165.00
	Blue	3PSFPP602	165.00	
	Yellow	3PSFPP802	165.00	



MRP w.e.f. 10.07.2023

**Control & Signalling Devices 22.5 Ø
PLASTIC SERIES (ECONOMY SERIES)**

MUSHROOM LATCHING PUSH BUTTONS				
	TYPE	COLOUR	ORDERING CODE	PRICE IN Rs.
	Mushroom Latching Ø 40mm with 1NO contact element	Red	3PSML410	180.00
	Mushroom Latching Ø 40mm with 1NC contact element	Red	3PSML401	180.00
	Mushroom Latching Ø 40mm with 1NO+1NC contact element	Red	3PSML411	220.00
	Mushroom Latching Ø 40mm with 2NO contact element	Red	3PSML420	220.00
	Mushroom Latching Ø 40mm with 2NC contact element	Red	3PSML402	220.00



MRP w.e.f. 10.07.2023
Control & Signalling Devices 22.5 Ø
PLASTIC SERIES (ECONOMY SERIES)

SELECTOR PUSH BUTTONS				
	TYPE	COLOUR	ORDERING CODE	PRICE IN Rs.
	Selector push button, 2 position, with 1 NO contact element	Black	3PSS210-2P	210.00
	Selector push button, 2 position, with 1 NC contact element	Black	3PSS201-2P	210.00
	Selector push button, 2 position, with 1 NO + 1 NC contact element	Black	3PSS211-2P	250.00
	Selector push button, 2 position, with 2 NO contact element	Black	3PSS220-2P	250.00
	Selector push button, 2 position, with 2 NC contact element	Black	3PSS202-2P	250.00



MRP w.e.f. 10.07.2023

**Control & Signalling Devices 22.5 Ø
PLASTIC SERIES (ECONOMY SERIES)**

SELECTOR PUSH BUTTONS				
	TYPE	COLOUR	ORDERING CODE	PRICE IN Rs.
	Selector push button, 3 position, with 1NO+1NC Contact Element	Black	3PSS211-3P	250.00
	Selector push button, 3 position, with 2NO contact element	Black	3PSS220-3P	250.00
	Selector push button, 3 position, with 2NC contact element	Black	3PSS202-3P	250.00

GENERAL TERMS AND CONDITIONS

General Terms : Prices are ex-works Mumbai
HSN CODE : 85365010 for all the products of this MRP List
GST : 18%

Prices are subject to revision without notice and ruling at the time of delivery.

This price list supersedes all previous Price Lists.

Warranty Policy : **TEKNIC equipment is guaranteed under the following terms:**

For a period of 12 months from the date of sale, TEKNIC guarantees that its products are free from defects in material and workmanship, with the exception of consumables rendered unserviceable through normal use. During the said period, TEKNIC will replace or repair all parts acknowledged as defective due to factory workmanship and which have been returned in a timely manner by Buyer to TEKNIC and all costs and duties paid, together with a detailed description of the failure and a certified declaration of the number of hours of operation. Repaired or replaced parts will be redelivered FCA (named place) as per INCOTERMS 2000. This warranty is subject to the provision of correct usage, proper maintenance and does not cover defects arising out of fire, faulty operation, accident, inefficient maintenance and willful or accidental damage.

TEKNIC guarantee applies to all equipment, parts and components stored, installed, protected, maintained and used in accordance with TEKNIC specifications and instructions, and respecting the rules for normal use, without any modification by Buyer.

All other conditions or warranties, whether express or implied, relating to the quality and operation of the equipment are excluded, as well as any liability for loss or damage caused directly or indirectly by the equipment or resulting from its use.

Proof of purchase to be provided to avail warranty.

TEKNIC ELECTRIC (I) PVT. LTD.

Reg.Office : 116, Hammersmith Industrial Estate, Mahim (W), Mumbai – 400016.
Head Office : 703/704/705, Madhava, Bandra Kurla Complex, Bandra (E), Mumbai – 400051. Tel : +91-22-42532500
Works : 65, Marol Co-op. Industrial Estate Ltd., M. Vassanji Road, Andheri (East), Mumbai – 400059. Tel : +91-22-42534500
Email : teknico@teknico.co.in mfg@teknico.co.in Website : www.teknico.co.in

Economy Series LED Pilot Lights Ø 22.5

MRP with effect from 10.07.2023



Salient Features:

- Quick installation
- Safe operation
- Robust design
- Aesthetically elegant
- Diffused illumination
- 2 LED chip cluster
- LVGP (Low Voltage Glow Protection)
- Marking on diffuser on request

Electrical and Mechanical Characteristics

Environment

Degree of protection	IP65 as per IEC 60529
Applicable standards	IEC 60947-5-1
Product Certification	CE
Ambient	-25°C to +70°C
Storage	-25°C to +40°C

Mechanical Characteristics:

Terminal Capacity	Maximum 2x1.5mm ² or 1x2.5mm ² . Minimum 1x 0.5mm ²
Terminal marking	X1 X2
Terminal Torque	0.5 Nm
Viewing Angle	More than 100°
Optical Axial intensity	More than 100 mcd for all colors
Weight	25 gms

Electrical Characteristics:

Rated insulation voltage	500 V
Dielectric Test	2.5 KV
Polymeric parts	V2 as per UL94
Polarity protection	Polarity protection is only in case of DC supply lamps
Current Consumption	Max. 20mA for AC circuits. Max. 15mA for DC circuits

Economy Series LED Pilot Lights Ø 22.5

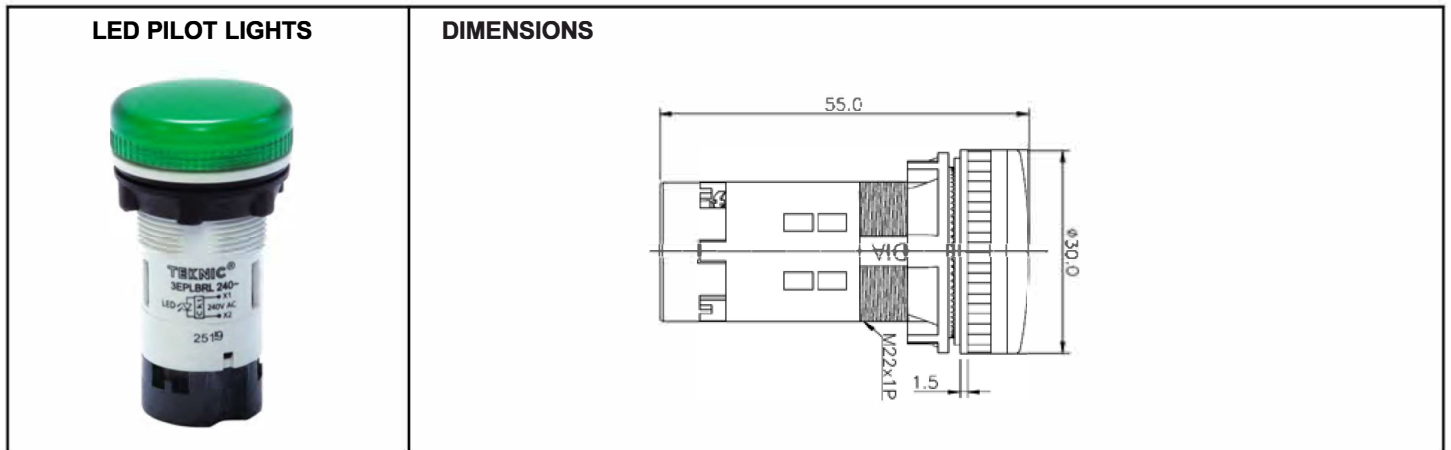

SPECIFIC VOLTAGE

VOLTAGE COLOUR ORDERING CODE COLOUR ORDERING CODE COLOUR ORDERING CODE COLOUR ORDERING CODE COLOUR ORDERING CODE

12 AC/DC	<input type="radio"/>	3EPLBR1L(S)12	<input checked="" type="radio"/>	3EPLBR3L12	<input checked="" type="radio"/>	3EPLBR4L12	<input checked="" type="radio"/>	3EPLBR5L12	<input checked="" type="radio"/>	3EPLBR6L12
	<input type="radio"/>	3EPLBR7L(S)12	<input checked="" type="radio"/>	3EPLBR8L12	<input type="radio"/>	Translucent Lens / White LED	<input type="radio"/>	Transparent Lens / White LED		
24 AC/DC	<input type="radio"/>	3EPLBR1L(S)24	<input checked="" type="radio"/>	3EPLBR3L24	<input checked="" type="radio"/>	3EPLBR4L24	<input checked="" type="radio"/>	3EPLBR5L24	<input checked="" type="radio"/>	3EPLBR6L24
	<input type="radio"/>	3EPLBR7L(S)24	<input checked="" type="radio"/>	3EPLBR8L24	<input type="radio"/>	Translucent Lens / White LED	<input type="radio"/>	Transparent Lens / White LED		
110 AC	<input type="radio"/>	3EPLBR1L(S)110AC	<input checked="" type="radio"/>	3EPLBR3L110AC	<input checked="" type="radio"/>	3EPLBR4L110AC	<input checked="" type="radio"/>	3EPLBR5L110AC	<input checked="" type="radio"/>	3EPLBR6L110AC
	<input type="radio"/>	3EPLBR7L(S)110AC	<input checked="" type="radio"/>	3EPLBR8L110AC	<input type="radio"/>	Translucent Lens / White LED	<input type="radio"/>	Transparent Lens / White LED		
110 DC	<input type="radio"/>	3EPLBR1L(S)110DC	<input checked="" type="radio"/>	3EPLBR3L110DC	<input checked="" type="radio"/>	3EPLBR4L110DC	<input checked="" type="radio"/>	3EPLBR5L110DC	<input checked="" type="radio"/>	3EPLBR6L110DC
	<input type="radio"/>	3EPLBR7L(S)110DC	<input checked="" type="radio"/>	3EPLBR8L110DC	<input type="radio"/>	Translucent Lens / White LED	<input type="radio"/>	Transparent Lens / White LED		
240 AC	<input type="radio"/>	3EPLBR1L(S)240AC	<input checked="" type="radio"/>	3EPLBR3L240AC	<input checked="" type="radio"/>	3EPLBR4L240AC	<input checked="" type="radio"/>	3EPLBR5L240AC	<input checked="" type="radio"/>	3EPLBR6L240AC
	<input type="radio"/>	3EPLBR7L(S)240AC	<input checked="" type="radio"/>	3EPLBR8L240AC	<input type="radio"/>	Translucent Lens / White LED	<input type="radio"/>	Transparent Lens / White LED		
220 DC	<input type="radio"/>	3EPLBR1L(S)220DC	<input checked="" type="radio"/>	3EPLBR3L220DC	<input checked="" type="radio"/>	3EPLBR4L220DC	<input checked="" type="radio"/>	3EPLBR5L220DC	<input checked="" type="radio"/>	3EPLBR6L220DC
	<input type="radio"/>	3EPLBR7L(S)220DC	<input checked="" type="radio"/>	3EPLBR8L220DC	<input type="radio"/>	Translucent Lens / White LED	<input type="radio"/>	Transparent Lens / White LED		

Note: Other voltages namely 6 V, 30 V, 48 V, 63.5 V & 125 V DC available on request

MRP w.e.f. 10.07.2023

Control & Signalling Devices 22.5 Ø

PLASTIC SERIES

LED PILOT LIGHTS ECONOMY SERIES

	TYPE	COLOUR	ORDERING CODE	Price in Rs. INTEGRAL LED
	Integral LED	White LED / White Lens	3EPLBR1L(S)	240.00
	6V, 12V, 24V, 48V AC/DC	Green LED / Green Lens	3EPLBR3L	130.00
	110VAC, 110VDC,	Red LED / Red Lens	3EPLBR4L	130.00
	230VAC, 220VDC	Amber LED / Amber Lens	3EPLBR5L	130.00
		Blue LED / Blue Lens	3EPLBR6L	240.00
		White LED / Clear Lens	3EPLBR7L(S)	240.00
		Yellow LED / Yellow Lens	3EPLBR8L	130.00
	Please mention the voltage required after the ordering code			

GENERAL TERMS AND CONDITIONS

General Terms : Prices are ex-works Mumbai

GST : 18%

Prices are subject to revision without notice and ruling at the time of delivery.

This price list supersedes all previous Price Lists.

Warranty Policy : TEKNIC equipment is guaranteed under the following terms:

For a period of 12 months from the date of sale, TEKNIC guarantees that its products are free from defects in material and workmanship, with the exception of consumables rendered unserviceable through normal use. During the said period, TEKNIC will replace or repair all parts acknowledged as defective due to factory workmanship and which have been returned in a timely manner by Buyer to TEKNIC and all costs and duties paid, together with a detailed description of the failure and a certified declaration of the number of hours of operation. Repaired or replaced parts will be redelivered FCA (named place) as per INCOTERMS 2000. This warranty is subject to the provision of correct usage, proper maintenance and does not cover defects arising out of fire, faulty operation, accident, inefficient maintenance and willful or accidental damage.

TEKNIC guarantee applies to all equipment, parts and components stored, installed, protected, maintained and used in accordance with TEKNIC specifications and instructions, and respecting the rules for normal use, without any modification by Buyer.

All other conditions or warranties, whether express or implied, relating to the quality and operation of the equipment are excluded, as well as any liability for loss or damage caused directly or indirectly by the equipment or resulting from its use.

Proof of purchase to be provided to avail warranty.

TEKNIC ELECTRIC (I) PVT. LTD.

Reg.Office : 116, Hammersmith Industrial Estate, Mahim (W), Mumbai – 400016.

Head Office : 703/704/705, Madhava, Bandra Kurla Complex, Bandra (E), Mumbai – 400051. Tel : +91-22-42532500

Works : 65, Marol Co-op. Industrial Estate Ltd., M. Vassanji Road, Andheri (East), Mumbai – 400059. Tel : +91-22-42534500

Email : teknic@teknic .co.in/mfg@teknic.co.in

Website : www.teknic.co.in

CH:MT:41
REV : E

LED Pilot Light Ø 16.5 plastic construction

MRP with effect from 10.07.2023



General Characteristics:

This range of LED Monoblock Pilot Light Ø 16.5 is available in round & square head in a variety of colours. This Pilot Light can be fixed in any position on panels of thickness varying from 1 mm to 6 mm. The pilot light is fastened to the panel with a lock ring. We recommend min fixing centres of 25 mm x 25 mm.

Pilot lights are available with integral LED's suitable for operating at various voltages, namely 6 V, 12 V, 24 V, 30 V, 48 V, 63 V, 110 V, 125 V & 240 V AC / DC.

Electrical and mechanical characteristics

A) Mechanical Characteristics

Applicable Standard	UL 508 IEC 60947-5-1 CSA 22.2
Degree Of Protection	IP 65 (as per IEC 60529) Dust & water tight
Operating Conditions	+ 70° C to -25° C
Contact Material	Brass (tin plated)
Corrosion Protection	All metallic parts are electroplated for corrosion protection
Terminal Torque	0.5 Nm
Viewing Angle	More than 100°
Optical Axial intensity	More than 100 mcd for all colors

B) Electrical Characteristics

Rating	Rated 6 VAC / DC, 12 VAC / DC, 24 AC / DC, 110 AC, 110 DC, 240 AC & 220 DC	
Terminal Capacity	Rigid	Flexible
	2 X 0.75 mm ² (max)	1 X 0.75 mm ² (max)
	1 X 0.5 mm ² (min)	1 X 0.5 mm ² (min)
	1 X 1.5 mm ² (min)	2 X 0.5 mm ² (mix)
Dielectric Test	2.5 KV	
Rated Insulation Voltage	500 VDC	
Polarity Protection	Nil	
Low Voltage Protection	20% of Rated Voltage	
Current Consumption	Max. 20 mA for AC Circuits	
	Max. 15 mA for DC Circuits	

16.5 Ø - PILOT LIGHTS WITH INTEGRAL LED

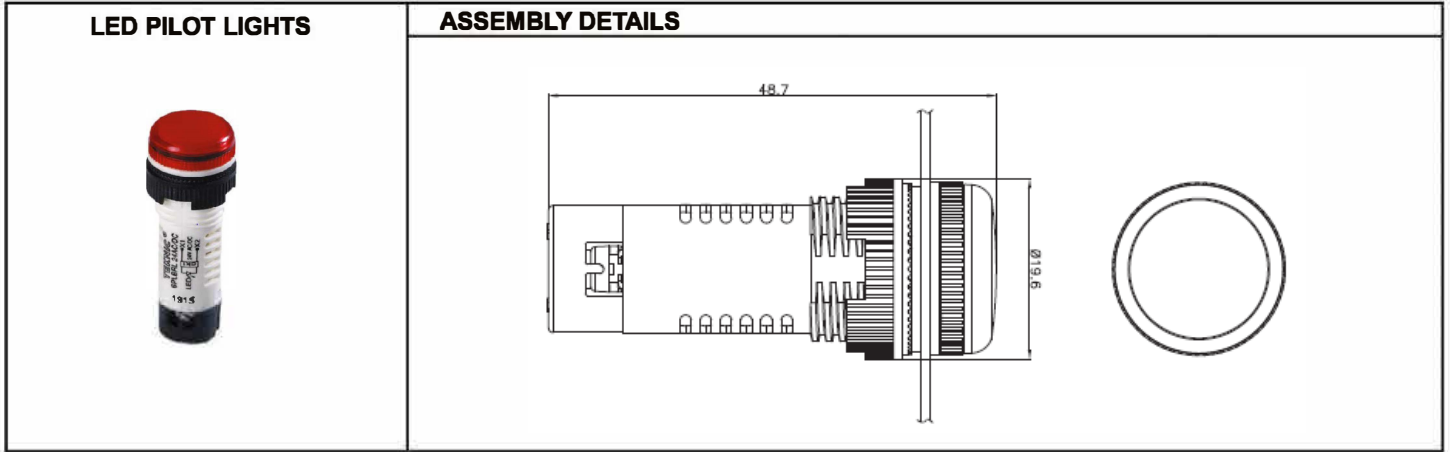

SPECIFIC VOLTAGE

VOLTAGE	COLOUR	ORDERING CODE	COLOUR	ORDERING CODE	COLOUR	ORDERING CODE	COLOUR	ORDERING CODE	COLOUR	ORDERING CODE
12 AC/DC	<input type="radio"/>	6PLBR1L (S)12	<input type="radio"/>	6PLBR3L12	<input type="radio"/>	6PLBR4L12	<input type="radio"/>	6PLBR5L12	<input type="radio"/>	6PLBR6L12
	<input type="radio"/>	6PLBR7L(S)12	<input type="radio"/>	6PLBR8L12	<input type="radio"/> Translucent Lens / White LED		<input type="radio"/> Transparent Lens / White LED			
24 AC/DC	<input type="radio"/>	6PLBR1L (S)24	<input type="radio"/>	6PLBR3L24	<input type="radio"/>	6PLBR4L24	<input type="radio"/>	6PLBR5L24	<input type="radio"/>	6PLBR6L24
	<input type="radio"/>	6PLBR7L(S)24	<input type="radio"/>	6PLBR8L24	<input type="radio"/> Translucent Lens / White LED		<input type="radio"/> Transparent Lens / White LED			
110 AC	<input type="radio"/>	6PLBR1L(S)110AC	<input type="radio"/>	6PLBR3L110AC	<input type="radio"/>	6PLBR4L110AC	<input type="radio"/>	6PLBR5L110AC	<input type="radio"/>	6PLBR6L110AC
	<input type="radio"/>	6PLBR7L(S)110AC	<input type="radio"/>	6PLBR8L110AC	<input type="radio"/> Translucent Lens / White LED		<input type="radio"/> Transparent Lens / White LED			
240 AC	<input type="radio"/>	6PLBR1L(S)240AC	<input type="radio"/>	6PLBR3L240AC	<input type="radio"/>	6PLBR4L240AC	<input type="radio"/>	6PLBR5L240AC	<input type="radio"/>	6PLBR6L240AC
	<input type="radio"/>	6PLBR7L(S)240AC	<input type="radio"/>	6PLBR8L240AC	<input type="radio"/> Translucent Lens / White LED		<input type="radio"/> Transparent Lens / White LED			

Note: Other voltages namely 6 V, 30 V, 48 V available on request



MRP w.e.f. 10.07.2023

**Control & Signalling Devices 16.5 Ø
PLASTIC SERIES**

LED PILOT LIGHTS ECONOMY SERIES					
	Type	Colour of LED / Lens	ORDERING CODE	Price in Rs. with Int. LED	
	Integral LED	White LED / White Lens	6PLBR1L(S)	300.00	
	6V, 12V, 24V, 48V AC/DC	Green LED / Green Lens	6PLBR3L	130.00	
	110VAC, 230VAC	Red LED / Red Lens	6PLBR4L	130.00	
		Amber LED / Amber Lens	6PLBR5L	130.00	
		Blue LED / Blue Lens	6PLBR6L	380.00	
		White LED / Clear Lens	6PLBR7L(S)	300.00	
		Yellow LED / Yellow Lens	6PLBR8L	130.00	
	Please mention the voltage required after the ordering code				

GENERAL TERMS AND CONDITIONS	
General Terms :	Prices are ex-works Mumbai
GST :	18%
HSN CODE :	85365010
Prices are subject to revision without notice and ruling at the time of delivery.	
This price list supersedes all previous Price Lists.	
Warranty Policy :	TEKNIC equipment is guaranteed under the following terms:
<p>For a period of 12 months from the date of sale, TEKNIC guarantees that its products are free from defects in material and workmanship, with the exception of consumables rendered unserviceable through normal use. During the said period, TEKNIC will replace or repair all parts acknowledged as defective due to factory workmanship and which have been returned in a timely manner by Buyer to TEKNIC and all costs and duties paid, together with a detailed description of the failure and a certified declaration of the number of hours of operation. Repaired or replaced parts will be redelivered FCA (named place) as per INCOTERMS 2000. This warranty is subject to the provision of correct usage, proper maintenance and does not cover defects arising out of fire, faulty operation, accident, inefficient maintenance and willful or accidental damage.</p>	
<p>TEKNIC guarantee applies to all equipment, parts and components stored, installed, protected, maintained and used in accordance with TEKNIC specifications and instructions, and respecting the rules for normal use, without any modification by Buyer.</p>	
<p>All other conditions or warranties, whether express or implied, relating to the quality and operation of the equipment are excluded, as well as any liability for loss or damage caused directly or indirectly by the equipment or resulting from its use.</p>	

Proof of purchase to be provided to avail warranty.

TEKNIC ELECTRIC (I) PVT. LTD.

Reg. Office : 116, Hammersmith Industrial Estate, Mahim (W), Mumbai – 400016. Tel.:43626500,24451648 Fax : 24468185
 Head Office : 703/704/705, Madhava, Bandra Kurla Complex, Bandra (E), Mumbai – 400051. Tel : +91-22-42532500 Fax :26592391
 Works : 65, Marol Co-op. Industrial Estate Ltd., M. Vassanji Road, Andheri (East), Mumbai – 400059. Tel : +91-22-42534500 Fax:28504273
 Email : teknico@teknico.co.in : mfg@teknico.co.in Website : www.teknico.co.in

CH:MT:26
REV:E

TEKNIC

Accessories for Metal & Plastic Series
Control and Signaling Devices Ø 22.5

MRP with effect from 10.07.2023







MRP w.e.f. 10.07.2023

Accessories for Control & Signalling Devices 22.5 Ø			
	TYPE	ORDERING CODE	PRICE IN Rs.
	PADLOCK	2PAM7	95.00
	For Locking mushroom act.		
	in actuated position		
	Head Ø 40mm		
	HSN CODE : 85389000		
	PADLOCK	2PAM7EH	125.00
	For Locking mushroom act.		
	in unactuated position		
	Head Ø 40mm		
	HSN CODE : 85389000		
	SHROUD	2ESS1	95.00
	For Mushroom act.		
	Head Ø 40mm		
	HSN CODE :40169990		
	SHROUD	2ESS2	105.00
	For Mushroom act.		
	Head Ø 40mm		
	HSN CODE :40169990		
	SHROUD	2ESS3	150.00
	For Mushroom act.		
	Head Ø 40mm		
	Shaft for fixing external	2ESS3S	35.00
	Padlock (2ESS3)		
	HSN CODE : 40169990		
	PADLOCK	2PAM	110.00
	For Estop		
	Head Ø 40mm		
	HSN CODE : 85389000		
	PADLOCK	2PAP	110.00
	For Flush / Projecting		
	Actuator		
	HSN CODE : 85389000		

MRP w.e.f. 10.07.2023

Accessories for Control & Signalling Devices 22.5 Ø

	TYPE	COLOUR	ORDERING CODE	PRICE IN Rs.
	LENS	TransWhite	2PLL1	36.00
	For Pilot lights	Green	2PLL3	36.00
	with Filament Bulb	Red	2PLL4	36.00
		Amber	2PLL5	36.00
		Blue	2PLL6	36.00
		Clear	2PLL7	36.00
	HSN CODE : 85389000	Yellow	2PLL8	36.00
	LENS	TransWhite	2PLL1L	36.00
	For Pilot lights	Green	2PLL3L	36.00
	with LED	Red	2PLL4L	36.00
		Amber	2PLL5L	36.00
		Blue	2PLL6L	36.00
		Clear	2PLL7L	36.00
	HSN CODE : 85389000	Yellow	2PLL8L	36.00
	LENS	TransWhite	2LAL1	36.00
	For Illuminated Actuator	Green	2LAL3	36.00
	with Filament Bulb	Red	2LAL4	36.00
		Amber	2LAL5	36.00
		Blue	2LAL6	36.00
		Clear	2LAL7	36.00
	HSN CODE : 85389000	Yellow	2LAL8	36.00
	LENS	TransWhite	2LAL1L	36.00
	For Illuminated Actuator	Green	2LAL3L	36.00
	with LED	Red	2LAL4L	36.00
		Amber	2LAL5L	36.00
		Blue	2LAL6L	36.00
		Clear	2LAL7L	36.00
	HSN CODE : 85389000	Yellow	2LAL8L	36.00

LEGEND PLATES (ALUMINIUM)									
	1 POSITION			2 POSITION					
	LEGEND	ORDERING CODE	PRICE IN Rs.	LEGEND	ORDERING CODE	PRICE IN Rs.			
	START	2LP01	26.00	START	2LP28	26.00			
	STOP	2LP02	26.00	UP	2LP29	26.00			
	FORWARD	2LP03	26.00	ON	2LP30	26.00			
	REVERSE	2LP04	26.00	REV.	2LP31	26.00			
	UP	2LP05	26.00	AUTO	2LP32	26.00			
	DOWN	2LP06	26.00	LOCAL	2LP33	26.00			
	OPEN	2LP07	26.00	I	2LP34	26.00			
	CLOSE	2LP08	26.00	O	2LP35	26.00			
	AUTO	2LP09	26.00						
	HAND	2LP10	26.00	3 POSITION					
	SLOW	2LP11	26.00	LEGEND		ORDERING CODE	PRICE IN Rs.		
	FAST	2LP12	26.00	HAND	AUTO	2LP36	26.00		
	RESET	2LP13	26.00	SLOW	FAST	2LP37	26.00		
	INCH	2LP14	26.00	UP	DOWN	2LP38	26.00		
	ON	2LP15	26.00	I	II	2LP39	26.00		
	OFF	2LP16	26.00	HSN CODE : 83100090					
	RIGHT	2LP17	26.00						
	LEFT	2LP18	26.00		LEGEND PLATE E-STOP(PLASTIC)		ORDERING CODE	PRICE IN Rs.	
	TRIP	2LP19	26.00		Yellow colour 60mm Ø with Black Characters		2LP41	26.00	
	POWER ON	2LP20	26.00	HSN CODE : 85389000					
	LOCAL	2LP21	26.00						
	REMOTE	2LP22	26.00						
	TEST	2LP23	26.00						
	RUN	2LP24	26.00						
	R PHASE	2LP25	26.00						
	Y PHASE	2LP26	26.00						
	B PHASE	2LP27	26.00						
OTHERS									
				LEGEND		ORDERING CODE	Price in Rs.		
				BLANK ALUMINIUM		2LP40	26.00		
				HSN CODE : 83100090					
	BLANKING PLUG		ORDERING CODE	PRICE IN Rs.	Spanner (Tightening Tool)		ORDERING CODE	PRICE IN Rs.	
	for 22.5 Ø hole, Black		2BP2	36.00		For tightening of lock nuts of plastic series actuator & pilot lights		P2SPNR	40.00
HSN CODE : 85389000				HSN CODE : 85365010					
	ADAPTOR		ORDERING CODE	PRICE IN Rs.	PUSH PUSH MECHANISM		ORDERING CODE	PRICE IN Rs.	
	Adaptor for fixing 22.5 Ø devices in 30.5 Ø cutout.		2ADP	27.00		For converting momentary actuators into latching type		2PPM	65.00
HSN CODE : 85389000				HSN CODE : 85389000					
	FIXING FLANGE		ORDERING CODE	PRICE IN Rs.	FIXING FLANGE		ORDERING CODE	PRICE IN Rs.	
	Metal Bracket for actuators & pilot lights		2BRK	46.00		Plastic Bracket for actuators & pilot lights		P2BRK	32.00
HSN CODE : 85389000				HSN CODE : 85389000					
	FLUSH MOUNTING ADAPTOR		ORDERING CODE	PRICE IN Rs.	SPARE KEY (for Key Selector Actuator)		ORDERING CODE	PRICE IN Rs.	
	Ø22.5 Plastic Series Flush Mounting Adaptor		2FMADP-1	62.00		Single Key		2KY-1	55.00
HSN CODE : 85389000				Two Keys		2KY-2	110.00		
				HSN CODE : 83017000					
BOOTS		ORDERING CODE	PRICE IN Rs.	FILAMENT BULB		ORDERING CODE	PRICE IN Rs.		
	Transparent Boot for non- illuminated flush actuators (2AF series)		2BT7	68.00		XX Please Put Voltage namely 12, 24, 30, 48, 130		BA9SXX	50.00
	Boot for illuminated flush actuators		2ALBT7	80.00		HSN CODE : 85391000			
	Boot for twin non- illuminated actuators		2ATBT7	85.00	LED BULB		COLOUR	ORDERING CODE	PRICE IN Rs.
	Boot for twin illuminated actuators		2ATLBT7	90.00		Please mention supply voltage 24 / 48 / 110AC / 110DC / 230AC / 220 DC after the part no. of LED bulbs			
		2BT2	68.00	SPECIAL WHITE		MCB91	350.00		
		2BT3	68.00	GREEN		MCB93	115.00		
		2BT4	68.00	RED		MCB94	115.00		
		2BT6	68.00	AMBER		MCB95	115.00		
		2BT8	68.00	BLUE		MCB96	380.00		
		2BT8	68.00	YELLOW		MCB98	115.00		
HSN CODE : 40169990				HSN CODE : 85414090					

GENERAL TERMS AND CONDITIONS

General Terms : Prices are ex-works Mumbai

GST : 18%

Prices are subject to revision without notice and ruling at the time of delivery.

This price list supersedes all previous Price Lists.

Warranty Policy : TEKNIC equipment is guaranteed under the following terms:

For a period of 12 months from the date of sale, TEKNIC guarantees that its products are free from defects in material and workmanship, with the exception of consumables rendered unserviceable through normal use. During the said period, TEKNIC will replace or repair all parts acknowledged as defective due to factory workmanship and which have been returned in a timely manner by Buyer to TEKNIC and all costs and duties paid, together with a detailed description of the failure and a certified declaration of the number of hours of operation. Repaired or replaced parts will be redelivered FCA (named place) as per INCOTERMS 2000. This warranty is subject to the provision of correct usage, proper maintenance and does not cover defects arising out of fire, faulty operation, accident, inefficient maintenance and willful or accidental damage.

TEKNIC guarantee applies to all equipment, parts and components stored, installed, protected, maintained and used in accordance with TEKNIC specifications and instructions, and respecting the rules for normal use, without any modification by Buyer.

All other conditions or warranties, whether express or implied, relating to the quality and operation of the equipment are excluded, as well as any liability for loss or damage caused directly or indirectly by the equipment or resulting from its use.

Proof of purchase to be provided to avail warranty.

TEKNIC ELECTRIC (I) PVT. LTD.

Reg. Office : 116, Hammersmith Industrial Estate, Mahim (W), Mumbai – 400016.

Head Office : 703/704/705, Madhava, Bandra Kurla Complex, Bandra (E), Mumbai – 400051. Tel : +91-22-42532500

Works : 65, Marol Co-op. Industrial Estate Ltd., M. Vassanji Road, Andheri (East), Mumbai – 400059. Tel : +91-22-42534500

Email : teknico@teknico.co.in mfg@teknico.co.in Website : www.teknico.co.in

TEKNIC



Control & Signaling Devices Ø22.5 Metal Series Joystick

MRP with effect from 10.07.2023



General Characteristics:

These are manually operated switches for installation in control panel & portable control equipment. They are used in steel, construction industry, machine tools, transport, conveyors, ware housing, studio, radio & cable control & cranes. They are used wherever motion sequences to actuation directions are controlled by hand. They are ideal for raising, lowering, moving to left or right. The switching elements are actuated by the joystick being moved out of intermediate position.

Note: The product is supplied as a single unit & not intended to be used without the special contact block/s attached to it. Product is factory fitted & warranty would be void if factory fitment is tampered. Standard contact elements (e.g. Model nos S1, S2... etc) cannot be used with this.

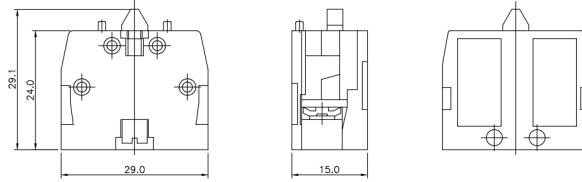

Mechanical Characteristics

Terminal Capacity	: Maximum 2 X 1.5 mm ² or 1 X 2.5 mm ² : Minimum 1 X 0.5 mm ²
Terminal marking	: 3 4
Terminal Torque	: 0.8 N.m
Operation	: Self-wiping, slow break
Mechanical life	: over 0.1 million operations
Ambient	: -25° C to +70° C
Storage	: -25° C to +40° C for 24 months stored in clean & dry surrounding
Mounting	: Can be mounted Vertical or Horizontal as required
	Fixing Centers 35 mm X 90 mm (2P/2PSR) A 90 mm X 90 mm (4P/4PSR) B

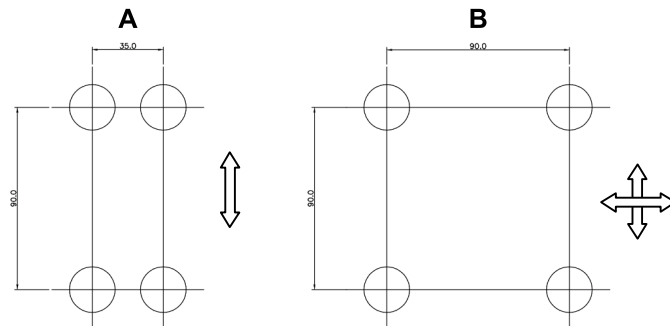

Mounting panel thickness: 1 mm to 6 mm
: with 2 elements: 120 X 40 X 30
: with 4 elements: 144 X 40 X 30

Overall Dimensions (LXBXH)

2PSJSXY0-2P/2PSR

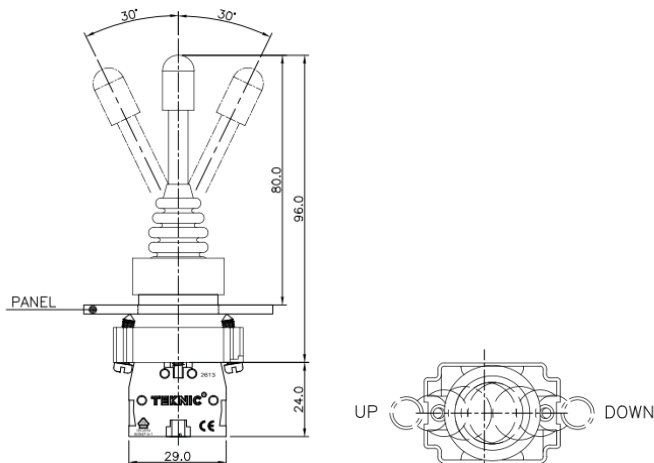

2PSJSXY0-4P/4PSR

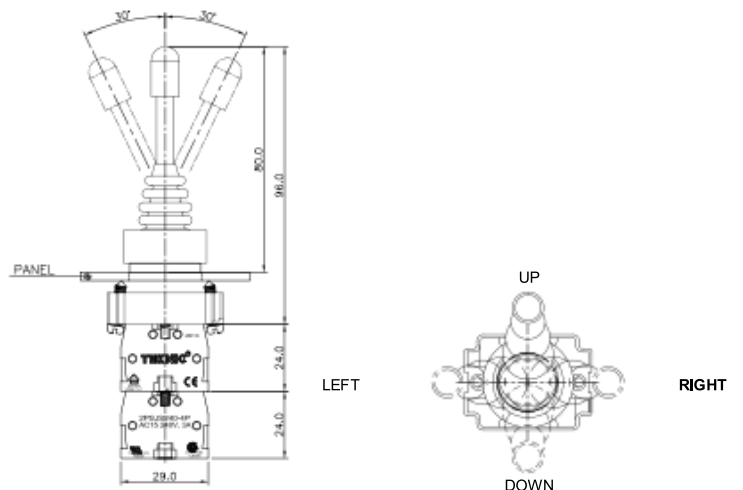

Electrical Characteristics:

Make & Break Capacity	: AC 15 3A, 240 V AC DC 13 0.5A, 110 V DC with a time constant of 300 ms A600, Q600
Rated insulation voltage	: 500 V
Rated thermal current	: 10A
Short circuit protection	: 10A HRC cartridge fuse, rated for resistive loading
Dielectric Test	: 2.5 KV
Approvals regarding the material Polymeric parts	: UL-Recognized material

Ordering codes for 2PSJSXY0-2P/4P/2PSR/4PSR

The ordering code for each product is mentioned on the product as well as the primary packing box.

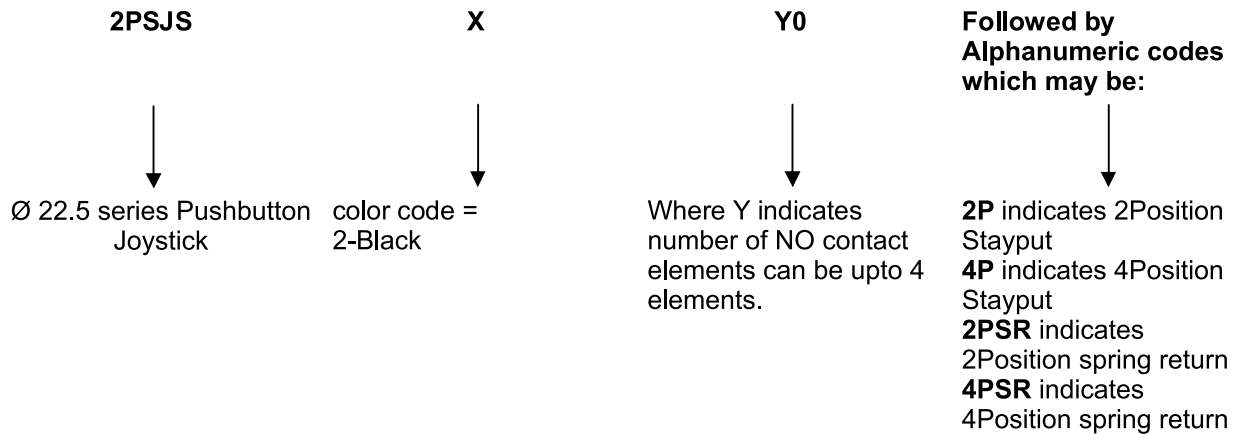

Mounting Instructions

Safety regulations: This unit may be installed & commissioned by trained personnel who are familiar with current regulation for health & safety at work & accident prevention. Ensure local regulations are met especially those relating to safety. This is for use on flat surface, IP65 & type 4X, 12 enclosure. Ensure that this pushbutton switch will operate fully after installation. Failure to follow these will result in malfunctioning of the switch & may cause damage to equipment or accident

To install:

1. Open the top sub assembly by rotating it in anticlockwise direction

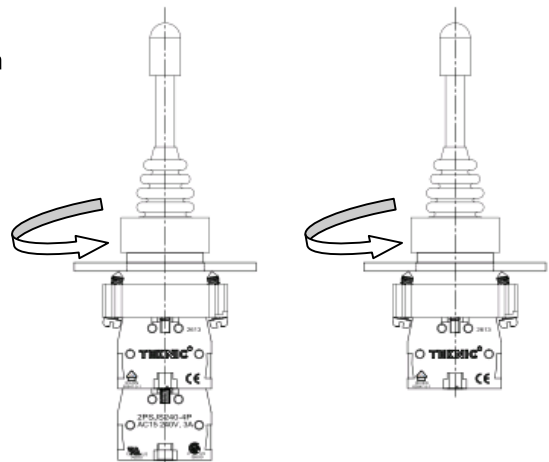

Mounting Instructions (Contd.)

2. Insert the JS bracket with element assembly from back of the panel of Ø 22.5 cutout.

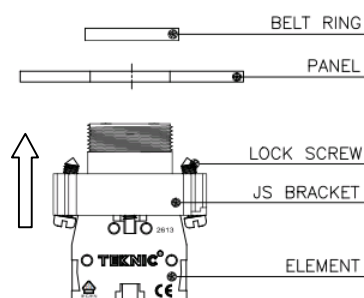

3. Ensure the belt ring is assembled from above the panel. **Fully tighten the top sub assembly by rotating clockwise**

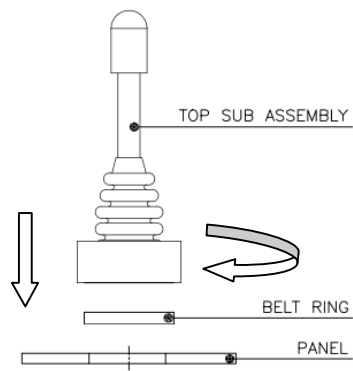

4. Tighten the lock screws in clockwise direction with a torque of 1.2Nm (max)

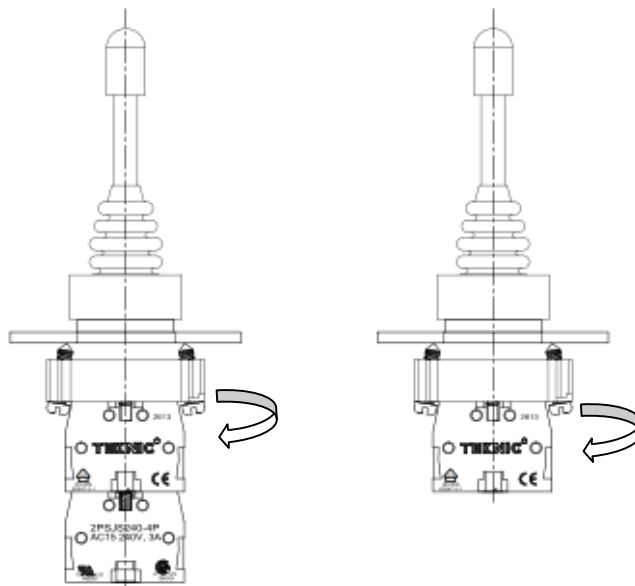

5. Check to see if the handle operates in 2P/4P directions, as applicable.

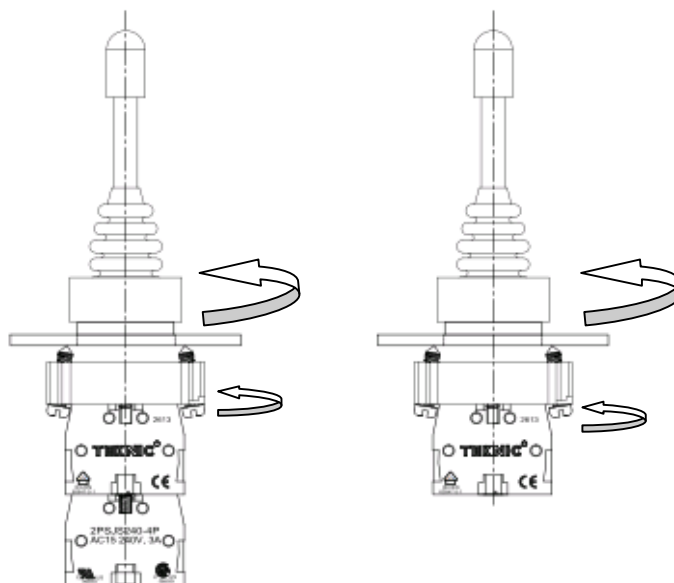

To uninstall:

1. Open the lock screws fully by turning anticlockwise direction
2. Rotate the top sub assembly in anticlockwise direction & the sub assemblies separates out



MRP w.e.f. 10.07.2023

**Control & Signalling Devices 22.5 Ø
METALLIC SERIES**

JOYSTICKS				
	TYPE	COLOUR	ORDERING CODE	Price in Rs.
	2 Position, Stayput	Black	2PSJS220-2P	2560.00
	2 Position, Spring Return	Black	2PSJS220-2PSR	2560.00
	4 Position, Statyput	Black	2PSJS240-4P	3350.00
	4 Position, Spring Return	Black	2PSJS240-4PSR	3350.00

GENERAL TERMS AND CONDITIONS

General Terms : Prices are ex-works Mumbai
 HSN CODE : 85365010 for all the products of this MRP List
 GST : 18%
 Prices are subject to revision without notice and ruling at the time of delivery.
 This price list supersedes all previous Price Lists.
 Warranty Policy : TEKNIC equipment is guaranteed under the following terms:

For a period of 12 months from the date of sale, TEKNIC guarantees that its products are free from defects in material and workmanship, with the exception of consumables rendered unserviceable through normal use. During the said period, TEKNIC will replace or repair all parts acknowledged as defective due to factory workmanship and which have been returned in a timely manner by Buyer to TEKNIC and all costs and duties paid, together with a detailed description of the failure and a certified declaration of the number of hours of operation. Repaired or replaced parts will be redelivered FCA (named place) as per INCOTERMS 2000. This warranty is subject to the provision of correct usage, proper maintenance and does not cover defects arising out of fire, faulty operation, accident, inefficient maintenance and willful or accidental damage.

TEKNIC guarantee applies to all equipment, parts and components stored, installed, protected, maintained and used in accordance with TEKNIC specifications and instructions, and respecting the rules for normal use, without any modification by Buyer.

All other conditions or warranties, whether express or implied, relating to the quality and operation of the equipment are excluded, as well as any liability for loss or damage caused directly or indirectly by the equipment or resulting from its use.

Proof of purchase to be provided to avail warranty.

TEKNIC ELECTRIC (I) PVT. LTD.

Head Office : 703/704/705, Madhava, Bandra Kurla Complex, Bandra (E), Mumbai – 400051. Tel : +91-22-42532500
 Works : 65, Marol Co-op. Industrial Estate Ltd., M. Vassanji Road, Andheri (East), Mumbai – 400059. Tel : +91-22-42534500
 Email : teknic@teknic .co.in mfg@teknic.co.in Website : www.teknic.co.in

TEKNIC



ENCLOSURES & ENCLOSING SOLUTIONS

• Automation • Escalators / Elevators • Project Applications

MRP w.e.f.10/07/2023



Enclosures for Customer Assembly

These Enclosures are for assembly by the user and can be mounted with the metallic or plastic series push buttons (please refer to the relevant catalogues for the range)

Degree of protection: IP 65, NEMA4X, 12
 Standards: IEC 60529, UL50
 Cable Entries: knock outs on plastic
 tapped holes on Aluminium

Colours:
 a) Plastic
 b) Aluminium

Yellow / Black, White / Black, Grey / Grey
 Yellow / Black, Grey / Black, Grey / Grey

Empty Enclosures ABS / Polycarbonate

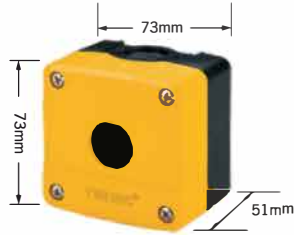

Assembly of Actuators and Contact Elements

Non illuminated push buttons with 3 contact elements
 Illuminated push buttons with 2 contact elements

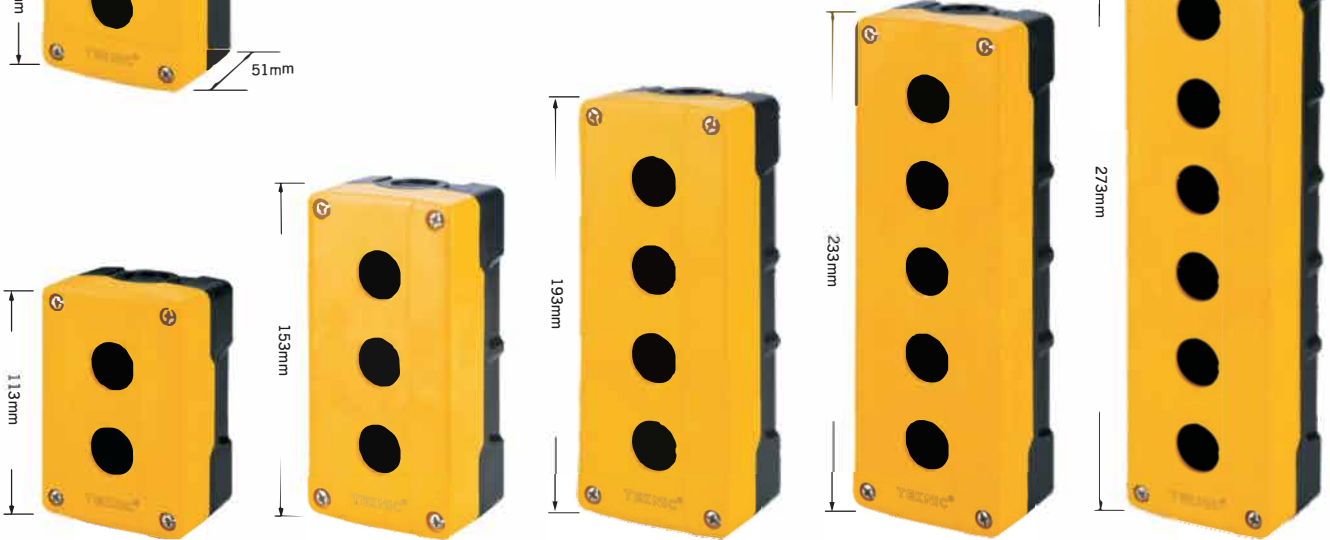

Empty Enclosures Aluminium (52mm depth)

Assembly of Actuators and Contact Elements

Non illuminated push buttons with 3 contact elements
 Illuminated push buttons with 2 contact elements



Empty Enclosures Aluminium (70mm depth)

Assembly of Actuators and Contact Elements

Non illuminated push buttons with 6 contact elements
 Illuminated push buttons with 4 contact elements



**MRP FOR CONTROL STATIONS IN ALUMINIUM HOUSING
EFFECTIVE FROM 10.07.2023
CONTROL STATIONS IN ALUMINIUM HOUSING**

1 WAY CONTROL STATION



COLOUR	PART NO.	ENCLOSURE SIZE	MRP PER UNIT	MOQ
Grey Cover / Black Housing	2005A13	80 mm x 90 mm x 52 mm	635.00	50 nos.
Yellow Cover / Black Housing	2005A10	80 mm X 90 mm X 52 mm	635.00	50 nos.

2 WAY CONTROL STATION



Grey Cover / Black Housing	2006C13	80 mm x 135 mm x 52 mm	730.00	50 nos.
Yellow Cover / Black Housing	2017C10	80 mm X 135 mm X 52 mm	730.00	50 nos.

3 WAY CONTROL STATION



Grey Cover / Black Housing	2007E13	80 mm x 180 mm x 52 mm	840.00	25 nos.
Yellow Cover / Black Housing	2014E10	80 mm X 180 mm X 52 mm	840.00	25 nos.

4 WAY CONTROL STATION



Grey Cover / Black Housing	2010G13	80 mm X 225 mm X 52 mm	960.00	25 nos.
Yellow Cover / Black Housing	2011G10	80 mm X 225 mm X 52 mm	960.00	25 nos.

MRP FOR CONTROL STATIONS IN ALUMINIUM HOUSING
EFFECTIVE FROM 10.07.2023
CONTROL STATIONS IN ALUMINIUM HOUSING

1 WAY CONTROL STATION



COLOUR	PART NO.	ENCLOSURE SIZE	MRP PER UNIT	MOQ
Grey Cover / Black Housing	7001A13	80 mm X 90 mm X 70 mm	795.00	50 nos.
Yellow Cover / Black Housing	7002A10	80 mm X 90 mm X 70 mm	795.00	50 nos.

2 WAY CONTROL STATION



Grey Cover / Black Housing	7001C13	80 mm X 135 mm X 70 mm	865.00	50 nos.
Yellow Cover / Black Housing	7002C10	80 mm X 135 mm X 70 mm	865.00	50 nos.

3 WAY CONTROL STATION



Grey Cover / Black Housing	7001E13	80 mm X 180 mm X 70 mm	1185.00	25 nos.
Yellow Cover / Black Housing	7002E10	80 mm X 180 mm X 70 mm	1185.00	25 nos.

4 WAY CONTROL STATION



Grey Cover / Black Housing	7002G10	80 mm X 225 mm X 70 mm	1290.00	25 nos.
Yellow Cover / Black Housing	7002G10	80 mm X 225 mm X 70 mm	1290.00	25 nos.

**MRP FOR CONTROL STATIONS IN ALUMINIUM HOUSING
EFFECTIVE FROM 10.07.2023
CONTROL STATIONS IN ALUMINIUM HOUSING**

6 WAY CONTROL STATION



COLOUR	PART NO.	ENCLOSURE SIZE	MRP PER UNIT	MOQ
Grey Cover / Grey Housing	2010J14	180mm x 200mm x 70 mm	2,270.00	10 nos.

9 WAY CONTROL STATION



Grey Cover / Grey Housing	2009L14	200mm x 250mm x 90 mm	3,370.00	10 nos.
---------------------------	---------	-----------------------	----------	---------

**MRP FOR CONTROL STATIONS IN PLASTIC HOUSING (ABS)
EFFECTIVE FROM 10.07.2023
CONTROL STATIONS IN PLASTIC HOUSING**

1 WAY CONTROL STATION



COLOUR	PART NO.	ENCLOSURE SIZE	MRP PER UNIT	MOQ
Yellow cover / Black housing	4005A11	73 mm X 73 mm X 51 mm	290.00	50 nos.
Yellow cover / Black housing	4006A10	73 mm X 73 mm X 51 mm	290.00	50 nos.

2 WAY CONTROL STATION



White cover / Black housing	4005C11	73 mm X 113 mm X 51 mm	425.00	50 nos.
Yellow cover / Black housing	4006C10	73 mm X 113 mm X 51 mm	425.00	50 nos.

3 WAY CONTROL STATION



White cover / Black housing	4005E11	73 mm X 153 mm X 51 mm	675.00	25 nos.
Yellow cover / Black housing	4006E10	73 mm X 153 mm X 51 mm	675.00	25 nos.

**MRP FOR CONTROL STATIONS IN PLASTIC HOUSING (ABS)
EFFECTIVE FROM 10.07.2023
CONTROL STATIONS IN PLASTIC HOUSING**

4 WAY CONTROL STATION



COLOUR	PART NO.	ENCLOSURE SIZE	MRP PER UNIT	MOQ
White cover / Black housing	4005G11	73 mm X 193 mm X 51 mm	735.00	25 nos.
Yellow cover / Black housing	4006G10	73 mm X 193 mm X 51 mm	735.00	25 nos.

5 WAY CONTROL STATION



White cover / Black housing	4005S11	73 mm X 233 mm X 51 mm	825.00	25 nos.
Yellow cover / Black housing	4006S10	73 mm X 233 mm X 51 mm	825.00	25 nos.

6 WAY CONTROL STATION



White cover / Black housing	4005I11	73 mm X 273 mm X 51 mm	900.00	25 nos.
Yellow cover / Black housing	4006I10	73 mm X 273 mm X 51 mm	900.00	25 nos.

1 WAY PLASTIC CONTROL STATIONS WITH YELLOW COVER / BLACK HOUSING WITH INTEGRAL CANOPY



Yellow cover / Black housing	6018A10	75 mm X 75 mm X 85 mm	425.00	25 nos.
---------------------------------	---------	-----------------------	--------	---------



GENERAL TERMS AND CONDITIONS

PRICES : Prices are ex-works Mumbai

TAXES : GST 18%

HSN : 85371000

Prices are subject to revision without notice and ruling at the time of delivery.

This price list supersedes all previous Price Lists.

Warranty Policy : TEKNIC equipment is guaranteed under the following terms:

For a period of 12 months from the date of sale, TEKNIC guarantees that its products are free from defects in material and workmanship, with the exception of consumables rendered unserviceable through normal use. During the said period, TEKNIC will replace or repair all parts acknowledged as defective due to factory workmanship and which have been returned in a timely manner by Buyer to TEKNIC and all costs and duties paid, together with a detailed description of the failure and a certified declaration of the number of hours of operation. Repaired or replaced parts will be redelivered FCA (named place) as per INCOTERMS 2000. This warranty is subject to the provision of correct usage, proper maintenance and does not cover defects arising out of fire, faulty operation, accident, inefficient maintenance and willful or accidental damage.

TEKNIC guarantee applies to all equipment, parts and components stored, installed, protected, maintained and used in accordance with TEKNIC specifications and instructions, and respecting the rules for normal use, without any modification by Buyer.

All other conditions or warranties, whether express or implied, relating to the quality and operation of the equipment are excluded, as well as any liability for loss or damage caused directly or indirectly by the equipment or resulting from its use.

Proof of purchase to be provided to avail warranty.

TEKNIC ELECTRIC (I) PVT. LTD.

Head Office : 703/704/705, Madhava, Bandra Kurla Complex, Bandra (E), Mumbai – 400051. Tel : +91-22-42532500

Works : 65, Marol Co-op. Industrial Estate Ltd., M. Vassanji Road, Andheri (East), Mumbai – 400059. Tel : +91-22-42534500

Email : teknico@teknico.co.in mfg@teknico.co.in Website : www.teknico.co.in

CH:MT:27
REV:H